

AB Technology Group Inc.

- Wire, Cable, Hose, Equipment & Personnel Protection

- Thermal Protection Solutions for cold, heat, flame, fire, weld splatter and liquid metal exposure
- Abrasion Resistance & Organization Solutions
- Silicone & Ceramic Thermal Adhesives
- High Temperature Ceramics
- Equipment Covers and Blankets for Thermal Efficiency & Personnel Protection

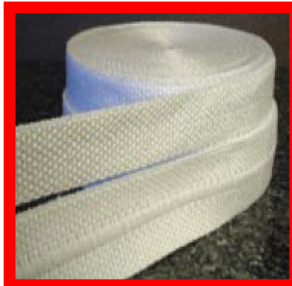

- Aerospace • Industrial • Commercial • Marine
- Military • Automotive • Bio-Pharma • Food
- Metal Processing • Mining • Petro-Chemical

Annual Catalogue # 22 / Rev Feb 2018

Please visit our web site for the latest version of this catalogue

1: SLEEVE / JACKET

2: TAPE / TADPOLE

3: ROPE / PACKING

4: FABRIC / CLOTH

5: INSULATION

6: Abrasion Protection Sleeve & Spiral Wrap. Wire Organization Sleeve and Shrink Tube

7: Custom Fabrications & Supplies

8: Ceramic Materials Rod, Plate, Bar, Fasteners, Crucibles

9: Silicone Rubber Tubing, Plugs, Extrusions, Heaters

10: Fire Stop / Retardant Foams, Caulk, Mortar Putty & Spray Wire & Cable Transits

11. Silicone & Ceramic Adhesives / Sealants Protective Coatings

12: METAL FOILS

Cross Reference Guides

Terms & Conditions
Account Application Form

© Copyright 2018 AB Technology Group. No part of this catalogue may be copied, reproduced or stored in an electronic retrieval system unless in its entirety, without alteration, modification or editing. All trade-marks and trade names are property of their respective owners.

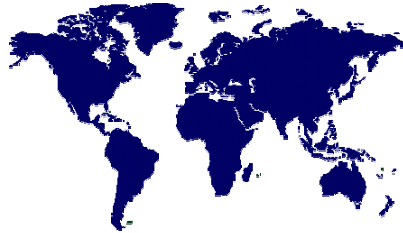

Thermal Protection Solutions™

Serious Solutions. Serious Service™

Keeping Our World Cooler™

Other Catalogues from A/B Technology Group

- **High Temperature Industrial Seals & Gaskets**
Feb 2015
- **Uncured Silicone Adhesives Sealants & Coatings**
Dec 2015

IMPORTANT NOTICE

Before using any product(s), you must evaluate it and determine if it is suitable for your intended application. You assume all risks and liability associated with such use.

With the exception of some silicone products designed for prosthetics, no product from A/B Technology Group may be used for medical devices or instruments without our express consent.

Warranty; Limited Remedy; Limited Liability.

Product will be free from defects in material and manufacture at the time of purchase. **A/B Technology Group makes no other warranties including, but not limited to, any implied warranty of merchantability or fitness for a particular purpose.** If this product is defective within the warranty period stated above, your exclusive remedy shall be, at A/B Technology Group's option, to replace or repair the product or refund the purchase price of the product. **Except where prohibited by law, A/B Technology Group will not be liable for any indirect, special, incidental or consequential loss or damage arising from this product, regardless of the legal theory asserted.**

Protection From:

Heat, Flame, Fire, Molten Splash, Weld Splatter, Grinding & Electrical Sparks, Infrared Radiant Heat, UV, Contamination, Abrasion & Harsh Chemicals

Providing Superior Protection for Hydraulic Hoses & Lines, Cables & Wires, Equipment & Personnel in Harsh and Extreme Environments

Primary Materials

Fiberglass (Fibreglass) – Nomex – Kevlar - Basalt - Silica – Ceramic – Alumina - Silicone Rubber - PTFE (Teflon[®] is a branded version of PTFE from DuPont) – Expanded PTFE – Viton[®] - EPDM – Neoprene - Stainless Steel – Inconel – Bronze – Monel - Hastalloy

Available Coatings

Vermiculite – PTFE – Viton[®] - Graphite – Silicone Rubber Elastomer – White Rubber - Acrylic Resin – Oleoresinous Varnish – Silicone Resin (Anti-Fray) - Aluminum & Stainless Steel (Heat Reflecting) Acrylic and Silicone Pressure Sensitive Adhesive (Self Adhesive)

Finished Products

**Sleeve – Tape – Fabric – Rope – Insulation - Gaskets & Seals
Custom Fabricated Curtains – Blankets – Shields – Covers
Tadpole Gaskets – Stove Gaskets - Oven Gaskets - Furnace Gaskets - Kiln Gaskets - Boiler Gaskets - Exhaust Duct Gaskets
Ring & Face Gaskets – Slit and Machined Envelope Gaskets
Silicone Electrical Strip Heaters
Fire Retardant Fabric Spray
Intumescent Firestop Paint & Coatings
General Industrial Gaskets
General Industrial Sheet Gasket and Packing – Compression Packings
Custom Fabricated Removable Pipe and Exhaust Insulation Blankets
Outdoor Non-Metallic Pipe Insulation & Protection Systems**

Products Proudly Made at USA & Canada Plants

Products

- ✓ **Silicone Rubber Coated Fiberglass High-Temperature Protection Materials**
- ✓ **High Temperature Silicone Rubber Adhesive, Sealant and End-Seal Dip**
- ✓ **Kevlar Protection Sleeve**
- ✓ **Nomex Protection Sleeve**
- ✓ **Very High-Temperature E-Type & S-Type Fiberglass Protection Materials**
- ✓ **Very High-Temperature Vermiculite Coated Protection Materials**
- ✓ **Extreme Temperature Silica Protection Materials**
- ✓ **Very High Temperature Graphite Coated Sleeve and Rope**
- ✓ **Extreme Temperature Plus Ceramic Fiber Protection Materials**
- ✓ **Radiant Heat Reflective Protection Materials**
- ✓ **High Temperature PTFE (Teflon® is a branded version of PTFE from DuPont) Coated Sleeve, Tape, Rope & Fabric**
- ✓ **High Temperature PTFE and ePTFE Ring and Full Face Gaskets**
- ✓ **High Temperature Slit PTFE Envelope Gaskets: TecPac™, TecBlue™, TecGraph™ Corrugated Steel, Stainless Steel, Neoprene or Viton fillers**
- ✓ **High Temperature Machined PTFE Envelope Gaskets: TecPac, TecBlue, Corrugated Steel, Stainless Steel, Neoprene or Viton fillers**
- ✓ **Abrasion, Wear and Blowout Protection Products for Hoses and Cables**
- ✓ **Stainless Steel Sleeve**
- ✓ **Mesh Rope Seals and Cores**
- ✓ **Very High Temperature & Extreme Temperature Custom Manufactured Blankets, Curtains, Shields & Covers. Welding Curtains, Blankets and pads.**
- ✓ **High Temperature Silicone Rubber Electrical Strip Heaters**
- ✓ **Fire Retardant Fabric Spray**
- ✓ **Intumescent Firestop Paint & Coatings**
- ✓ **General Industrial Gaskets**
- ✓ **General Industrial Sheet Gasket and Packing**
- ✓ **Compression Packings for Valves and Shafts**
- ✓ **Custom Fabricated Removable Pipe and Exhaust Insulation Blankets**
- ✓ **Outdoor Non-Metallic Pipe Insulation & Protection Systems**

Catalog Contents

Item.....	Page
Catalogue Contents.....	i
Technical Notes.....	vii
Selecting Materials.....	x
How To Order.....	xi
1. Sleeve / Jacket / Hose - Ducting	
500°F / 260°C Firesleeve - Silicone Rubber Coated Fiberglass Sleeve	
FlameShield™ firesleeve – Industrial & Heavy Duty:	1-1
FlameShield™ firesleeve – AS1072 Aviation Aerospace Grade:	1-3
FlameShield™ firesleeve – DIN EN ISO 15540 Marine Grade:	1-4
FlameShield™ firesleeve – Technical Specifications	1-5
Firesleeve Accessories: End Seal Dip & End Seal Paste	1-6
Firesleeve Accessories: End Wrap Tape Meeting MIL-I-46852 / A-A-59163	1-7
Firesleeve Accessories: 304 & 316 Stainless Steel Clamps	1-8
Firesleeve Accessories: Clamp Tool	1-14
500°F / 260°C Firesleeve with Hook & Loop Velcro® Closure	
FlameShield™ Industrial Firesleeve with Velcro Closure: <i>Small Diameter</i>	1-15
FlameShield™ Industrial Firesleeve with Velcro Closure: <i>Large Diameter</i>	1-16
ZeusGard™ Aviation Firesleeve with Hook & Loop Velcro® Closure	1-17
500°F / 260°C Firesleeve with Snaps / Zipper Closure	
FlameShield™ firesleeve with Snap Closures: <i>Heavy Duty Removable Molten Splash Protection</i>	1-18
FlameShield™ firesleeve with Zipper Closures: <i>Heavy Duty Removable Molten Splash Protection</i>	1-20
464°F / 240°C Silicone Rubber Coated Fiberglass Small Diameter Sleeve - Heavy Wall	
Small Diameter Heavy-Wall Sleeve: <i>Silicone Rubber Coated Fiberglass Sleeve with UL/CSA rating NEMA TF-1</i>	1-21
500°F / 260°C Silicone Rubber Coated Fiberglass Small Diameter Sleeve - AWG Wire Sized	
Small Diameter Thin-Wall Sleeve: <i>Silicone Rubber Coated Fiberglass Sleeve with UL/CSA rating NEMA TF-1</i>	1-21
428°F / 220°C VITON® 231 Coated Fiberglass Small Diameter Sleeve	
Small Diameter Thin-Wall Sleeve: <i>VITON® 231 Coated Fiberglass Sleeve with UL/CSA rating NEMA A1/B1/C1</i>	1-23
392°F / 200°C StretchSleeve™ Silicone Rubber Coated Sleeve	
Firesleeve with high elasticity: <i>Silicone Rubber Coated Fiberglass Sleeve with UL/CSA rating</i>	1-25
550°F / 287°C DeltaGlass™ Fiberglass with PTFE Coating	
Braided Fiberglass Sleeve with PTFE Coating	1-26
Specialty Sleeve with Velcro Closure:: PTFE Coated Fiberglass	1-27
320°F / 160°C FlameShield™ Kevlar Aramid Braided Sleeve – Premium Grade	
Kevlar Braided Aramid High Temperature, Heat & Flame Resistant Sleeve, Standard Wall	1-28
Kevlar Braided Aramid High Temperature, Heat & Flame Resistant Sleeve, Colored - Standard Wall	1-29
Kevlar Braided Aramid High Temperature, Heat & Flame Resistant Sleeve, Thin Wall	1-30
Kevlar Braided Aramid High Temperature, Heat & Flame Resistant Sleeve, Heavy Wall	1-31
662°F / 350°C FlameShield™ Nomex Braided Sleeve – Premium Grade	
High Temperature, Heat & Flame Resistant Nomex® Sleeve	1-32
1200°F / 648°C DeltaGlass™ Fiberglass – E Glass, S Glass	
Knitted Sleeve – Premium Grade	1-33
Braided Sleeve – Premium Grade	1-34
Braided Sleeve – Industrial Grade	1-35
Braided Heat Treated Sleeve – Premium Grade – Medium Size Range	1-36
Braided Sleeve – High Bulk Texturized	1-37
Braided Saturated Expandable Sleeve – Premium Grade	1-38
Braided Sleeve: S-Glass Precision Small Diameter / Thin Wall: Plain or Heat Treated	1-39
Braided Sleeve: S-Glass Precision Small Diameter / Thin Wall: Heat Treated w/ Binders	1-41
Braided Sleeve: E-Glass Precision Small Diameter / Standard Wall: Heat Treated – w/Binders	1-42
Braided Sleeve: E-Glass Precision Small Diameter / Heavy Wall: Heat Treated – w/Binders	1-43
Braided Sleeve: E-Glass Precision Premium Grade / Special Thin Wall .006 & .008: Plain and with Binders	1-44
Braided Sleeve: E-Glass Precision Small Diameter / Standard Wall: Heat Treated with Acrylic coating	1-45

Braided Sleeve – BlackMax Exhaust Pipe Protection	1-47
1200°F / 648°C DeltaGlass™ Fiberglass with Graphite Impregnation	
Braided Sleeve with Graphite Impregnation	1-48
1382°F / 750°C ExhaustSock™ 1500 Basalt Fiber Knitted Conformable Exhaust Pipe Sleeve	
Braided Basalt Sleeve – Premium Grade	1-49
1500°F / 815°C FlameShield™ 1500 Fiberglass Based with Vermiculite Coating	
Braided Sleeve w/Vermiculite Coating – Premium Grade	1-50
Braided Sleeve w/Vermiculite Coating – High Bulk Texturized - Premium Grade	1-51
1500°F / 815°C Specialty Sleeves with Velcro for Weld Splatter Protection	
Specialty Sleeve with Velcro Closure:: FG / WeldShield™	1-52
1800°F / 982°F InSilMax™	
InSilMax™ Braided Silica Sleeve	1-53
1800°F / 982°F InSilMax™ +PL	
InSilMax™ +PL Heavy Wall Braided Sleeve	1-54
1900°F / 1037°F InSilMax™ XT Silica	
InSilMax™ XT Braided Sleeve	1-55
2000°F / 1093°C CerMax™ Ceramic Fiber Braided Sleeve	
High Temperature, Heat & Flame Resistant Sleeve	1-56
2300°F / 1260°C AluMax™ Alumina Braided Sleeve	
High Temperature, Heat & Flame Resistant Sleeve	1-57
1200°F / 648°C FlameShield™ Spark Plug & Ignition Wire Boot Protection Sleeve	
High Temperature, Heat & Flame Resistant Sleeve	1-58
1000°F / 537°C DeltaGlass™ Fiberglass with Heat Reflective Coating	
Heat Reflective Aluminum Coated Fiberglass Split-Sleeve with adhesive closure	1-59
Heat Reflective Aluminum Coated Fiberglass Sleeve	1-60
Heat Reflective Aluminum Coated Fiberglass Sleeve, High Bulk Convuluted	1-61
Heat Reflective Aluminum Coated Fiberglass Sleeve forming Tape with adhesive strip	1-62
Sewn Sleeve with Aluminum Foil Coating	1-63
Sewn Sleeve with Aluminum Film Coating	1-64
Sewn Sleeve with Aluminum Foil Coating & Velcro Closure	1-65
Sewn Sleeve with Aluminum Film Coating & Velcro Closure	1-66
Sewn Sleeve with Stainless Steel Coating & Velcro Closure	1-67
1832°F / 1000°C Tinned Copper Metal Braided Sleeve: Tubular	
Tubular	1-68
Flat	1-70
1472°F / 800°C Brass Braided Sleeve	
Tubular	1-72
2500°F / 1371°C Stainless Steel Metal Braided Sleeve – Hose Size & Standard Size	
Stainless Steel Braided Sleeve – Hose Size / 304SS / 321SS / 316L SS – Heavy Duty	1-73
Stainless Steel Braided Sleeve – Standard Size	1-74
1200°F / 648°C Stainless Steel Hollow Knitted Mesh Sleeve	
Stainless Steel Hollow Knitted Mesh Sleeve	1-75
1200°F / 648°C Solid Wall Flexible Stainless Steel Sleeve	
Solid Wall Metal Flexible Sleeve	1-76
302°F / 150°C FlameShield™ EMI Shield Sleeve	
High Temperature, Heat & Flame Resistant Sleeve with 1 Mhz – 1 GHz EMI Shielding	1-77
HOSE / DUCTING	
<u>Hose / Duct:</u> 1500°F / 815°C FlameShield™ Exhaust Hose	
High Temperature, Heat & Flame Resistant Hose for metal processing ventilation	1-78
<u>Hose / Duct:</u> 300°F / 148°C FlameShield™ Exhaust Hose	
High Temperature, Heat & Flame Resistant Hose for welding applications ventilation	1-79
Sleeve Size Reference Chart	1-80

2. Tape, Tadpole Tape & Lacing Tape

320°F / 160°C Kevlar Woven Aramid Tape - Premium Grade

FlameShield Kevlar Woven Aramid Tape - MIL-T-871302-1

392°F / 200°C Fiberglass Fine Weave Tape with Silicone Adhesive

Glass Cloth High Temperature Tape – UL & Mil-i-19166C2-2

Glass Cloth High Temperature Tape2-3

500°F / 260°C FlameShield™ Silicone Rubber Coated Fiberglass Tape

Tape & Wrap: *One Side Coated Silicone Rubber Coated Knitted Fiberglass Tape – non adhesive*2-4

Heavy Duty Tape & Wrap: *One Side Coated Silicone Rubber Coated Woven Fiberglass Tape – non adhesive*2-5

Two-Side Coated Silicone Rubber Fiberglass Tape & Wrap – *non adhesive*2-6

Two-Side Coated Silicone Rubber Fiberglass Tape & Wrap - Premium – *non adhesive*2-7

500°F / 260°C FlameShield™ Silicone Rubber Self Fusing Tapes

MIL Spec Silicone Rubber Self Fusing Tape: *Meets MIL-I-46852 / A-A-59163*2-8

MIL-I-46852 Class 1 Type I & Type II2-11

AA59163-Class 1 Type I & Type II2-14

AA59163-Class 2 Type IM & Type IIM2-17

MIL Spec Silicone Rubber Reinforced Limited Stretch Self Fusing Tape: *Meets MIL-I-22444*2-20

Silicone Rubber Self Fusing Tape: *Meets DMS2186 Type I and DMS2186 Type II*2-21

Silicone Rubber Self Fusing Tape: *Meets Lockheed-Martin MMSJ517: Type I & Type II*2-22

Silicone Rubber Self Fusing Tape: *Meets Lockheed-Martin Space Systems 5-00857 & 5-00615*2-23

Silicone Rubber Self Fusing Tape: *Meets Lockheed-Martin Tactical Systems P5189*2-24

Silicone Rubber Self Fusing Tape: *Meets Lockheed-Martin Systems Integration 6084744*2-25

Silicone Rubber Self Fusing Tape: *Meets General Dynamics P5384*2-26

Silicone Rubber Self Fusing Tape: *Meets UL 94V0 & UL 94HB*2-27

Silicone Rubber Self Fusing Tape: *Meets Rockwell International ST0130RB0078: Type I & Type II*2-28

Silicone Rubber Self Fusing Tape: *Meets GE Power Generation A50A493 & 3003M70*2-29

Silicone Rubber Self Fusing Junction Insulation Tape: *Meets GE Transportation A50E112 & EMS2074*2-30

Silicone Rubber Self Fusing Tape: *Meets Rohr RMS315*2-31

Silicone Rubber Self Fusing Tape: *Meets Garmin 249-0014-00*2-32

Silicone Rubber Self Fusing Tape: *Amphenol Backshell Clamp Tape/Bushing*2-33

Silicone Rubber Self Fusing Tape: *Meets FAR 25.853 Appendix F Horizontal & Vertical Burn Rate Limits*2-34

Silicone Rubber Self Fusing Tape: *Meets MIL-I-46852 / A-A-59163 with NSN Number Assignment*2-35

ColeFlex TYT200-1 “No Heat” Silicone Self Fusing Tape2-36

MOX 602 / MOX 603 / MOX 604 T Series MIL Spec Silicone Rubber Self Fusing Tape2-37

MOX 620 / MOX 630 / MOX 640 R Series MIL Spec Silicone Rubber Self Fusing Tape2-38

66N / 67N / 68N / 69N / 78N / 79N Silicone Rubber Self Fusing Tape2-39

RL6000SA / RL6000SB StretchTape™ Equivalent Silicone Rubber Self Fusing Tape2-40

ABS5334A01 & ABS5334A02R Silicone Rubber Self Fusing Electrical Insulating Tape2-41

Eaton Weatherhead A6900W Equivalent Tape2-42

Simrit - Freudenberg NOK Equivalent Tape - Type I & Type II: *Meets MIL-I-46852 / A-A-59163*2-43

Simrit - Freudenberg NOK Equivalent Tape - Type I & Type II: *Meets MIL-I-22444 / MIL-I-46852 / A-A-59163*2-44

L-3 Communications Tape 40014362:2-45

3M Scotch® 70 Equivalent Tape2-46

GE and EMD Semi-Cured and Uncured Traction Motor Coil Encapsulating Tape2-47

PipeSeal Drain Pipe Leak Sealing Tape – Septic Inlet and Drain Pipe Leak Sealing2-48

DuctSeal Stovepipe and Flue Gas Duct Sealing Tape2-49

550°F / 287°C DeltaGlass™ Gasket Seal Tape with PTFE Coating

Fiberglass Gasket Seal Tape with PTFE Coating: Premium Grade2-50

Fiberglass Gasket Seal Tape with PTFE Coating: Industrial Grade2-51

550°F / 287°C DeltaGlass™ Tape with PTFE Resin Impregnation & Self Adhesive

Fiberglass Tape with PTFE Resin Impregnation & Self Adhesive; Premium2-52

Fiberglass Tape with PTFE Resin Impregnation & Self Adhesive; Industrial2-53

550°F / 287°C Skived PTFE Tape with Self Adhesive

Skived PTFE Tape with Self Adhesive2-54

550°F / 287°C MIL-I-23594 / MIL-I-59474 / AA-59474 Skived PTFE Tape with Self Adhesive

Skived PTFE Tape with Self Adhesive2-55

550°F / 287°C ePTFE Joint Seal Tape

Expanded PTFE Joint Seal Tape2-56

550°F / 287°C DeltaGlass™ Tape with PTFE Resin Impregnation, Non Adhesive / FDA	
Fiberglass Tape with PTFE Resin Impregnation, Non Adhesive / FDA; Premium	2-57
Fiberglass Tape with PTFE Resin Impregnation, Non Adhesive / FDA; Industrial	2-58
550°F / 287°C Tuff-Flex™ Tacky Cloth Rubberized Fiberglass Tape	
Universal Rubberized Fiberglass Gasket Tape (Tacky Cloth): with / without Wire Insert	2-59
Luting & Groove Packing - Wire Inserted	2-60
1200°F / 648°C DeltaGlass™ Plain Fiberglass Knitted & Woven Tape	
Woven Fiberglass Electrical Apparatus Insulating Tape	2-61
Fiberglass Knitted Plain Tape & Bolt Hole / Ladder Tape: Premium Grade	2-62
Fiberglass Woven Plain & Bolt-Hole / Ladder Tape – Premium Grade	2-63
Fiberglass Woven Plain & Bolt-Hole / Ladder Tape – Premium Grade with PSA Adhesive	2-64
Fiberglass Woven Plain & Bolt-Hole / Ladder Tape - Industrial Grade	2-66
Fiberglass Woven Plain & Bolt-Hole / Ladder Tape - Heat Treated-Heat Cleaned	2-67
Fiberglass Woven Plain & Bolt-Hole / Ladder Tape – Premium Grade / Special Thin	2-68
Fiberglass Woven Plain Tape – Color Coded	2-69
1350°F / 732°C ProSil™ Silica/Glass Woven Tape	
ProSil™ Silica/Glass blend tape	2-70
1500°F / 815°C FlameShield™ 1500 - Fiberglass Woven Tape with Vermiculite Coating	
Meets ASTM-E-162, ASTM-E-662 & SMP-800-C Flammability and Toxic Gas Production Limits	
Fiberglass with Vermiculite Coating Tape, Plain & Bolt-Hole / Ladder Tape – Premium Grade	2-72
Fiberglass with Vermiculite Coating Tape, Plain & Bolt-Hole / Ladder Tape – Industrial Grade	2-74
Fiberglass with Vermiculite Coating Tape, Plain & Bolt-Hole / Ladder Tape – Premium Grade / Special Thin	2-76
1100°F / 593°C to 1500°F / 815°C DeltaGlass™ PowerTorque™ Tape	
Automotive Manifold, Header, Turbo & Exhaust Pipe Tape & Wrap	2-77
1800°F / 982°C InSilMax™ Silica Tape	
InSilMax Silica Slit Tape	2-78
InSilMax Silica Slit Tape with PSA adhesive	2-79
InSilMax Silica Folded & Stitched Tape	2-80
InSilMax Silica Woven Tape	2-81
1900°F / 1037°C InSilMax™ XT Silica Tape	
InSilMax XT Silica Woven Tape	2-82
2000°F / 1093°C CerMax™ Ceramic Fiber Tape	
CerMax™ Ceramic Fiber Tape	2-84
950°F / 510°C to 5400°F / 2982°C GraphTek™ Flexible Graphite Tape	
GraphTek™ Flexible Graphite Tape	2-86
1000°F / 537°C DeltaGlass™ Fiberglass Base with Heat Reflective Coating	
Fiberglass with Aluminum Foil Coated Tape	2-87
Fiberglass with Stainless Steel Foil Coated Tape	2-88
Aluminum Foil Tape with Acrylic Adhesive, MIL-T-23397B Type 2	2-89
Lead Foil Tape with Natural Rubber Adhesive	2-90
Gold Look Colored Aluminized PET Film with Acrylic Adhesive	2-91
Aluminum Foil Coated Fiberglass Tape	2-92
Weld Backing Tape	2-93
InsulSave™ Insulated Pipe Wrap Tape	2-94
Pressure Sensitive Adhesive Spray & Tape for Mounting Assistance:	
FlangeStik™ Pressure Sensitive Adhesive Spray for Tape Mounting	2-98
Insulating Tape Mounting Tape	2-99

Tadpole Tapes

500°F / 260°C Silicone Rubber Based

Silicone Rubber "P" Tadpole Gasket Seal	2-101
Stainless Mesh Tadpole with Silicone Rubber Bulb	2-101

550°F / 287°C Aramid High Strength Tadpole

Aramid Tadpole Gasket Tapes	2-102
-----------------------------------	-------

1200°F / 648°C Fiberglass Based

Fiberglass Precision Tadpole Gasket Tapes	2-103
Fiberglass Heavy Duty Tadpole: Rope or Wire Mesh Core	2-104

1350°F / 732°C ProSil™ Silica/Glass Blend

High performance ProSil™ Silica/Fiberglass Blended Fabric Tadpole Gasket Tapes	2-105
High performance ProSilMax™ Silica/Fiberglass Blended Fabric with wire insert Tadpole Gasket Tapes	2-106

1500°F / 815°C Fiberglass Based w/ Vermiculite Coating FlameShield™ 1500

Meets ASTM-E-162, ASTM-E-662 & SMP-800-C Flammability and Toxic Gas Production Limits

Fiberglass with Vermiculite Coating Tadpole: Heavy Duty with Rope or Wire Mesh Core	2-107
---	-------

1800°F / 982°F InSilMax™ Silica

Silica Heavy Duty Tadpole with Rope or Wire Mesh Core	2-108
---	-------

1900°F / 1037°F InSilMax™ XT Silica

Silica Heavy Duty Tadpole with Rope or Wire Mesh Core	2-109
---	-------

2000°F / 1093°F CerMax™ Ceramic

Silica Heavy Duty Tadpole with Rope or Wire Mesh Core	2-110
---	-------

Tadpoles with Specialized Coatings

550°F / 287°C PTFE Coated Fiberglass

Fiberglass with PTFE Coating Heavy Duty Tadpole – Rope or Wire Mesh Core	2-112
--	-------

550°F / 287°C Tuff-Flex™ Tacky Cloth Rubberized Fiberglass

Rubberized Fiberglass Heavy Duty Tadpole - Rope Core with / without Wire Insert	2-113
---	-------

550°F / 287°C expanded PTFE

Expanded PTFE Tadpole Tapes 550°F / 287°C	2-114
---	-------

TTWearGuard™ Tadpole Tape Cover Mesh

Stainless Steel Mesh Cover for Tadpole Tape Enhanced Abrasion Resistance	2-115
--	-------

Lacing Tapes

Wiring bundling and organization

Nylon Lacing Tape A-A-52080 Type I / MIL-T-43435	2-118
Polyester Dacron Lacing Tape A-A-52081 Type II / MIL-T-43435	2-119
PTFE Fluorocarbon Teflon Lacing Tape A-A-52082 Type III / MIL-T-43435	2-120
Fiberglass (E-grade) Lacing Tape A-A-52083 Type IV / MIL-T-43435	2-121
Nomex Meta Aramid Lacing Tape A-A-52084 Type V / MIL-T-43435	2-122

3. Rope and Packing

320°F / 160°C Kevlar® 12-Strand Single Braid Rope

FlameShield™ Kevlar High Temperature Heat Resistant High Strength & Cut Resistant	3-1
---	-----

500°F / 260°C Solid Silicone Rubber Cord / Rope

FlameShield™ Silicone Rubber Cord / Rope	3-2
--	-----

392°F / 200°C Silicone Sponge Cord

FlameShield™ Silicone Rubber Sponge Cord	3-3
--	-----

500°F / 260°C Silicone Rubber Coated Fiberglass

FlameShield™ Fiberglass Rope with Silicone Rubber Coating: <i>Gasket Rope for Liquid / Gas / Steam</i>	3-4
--	-----

550°F / 287°C Acrylic Braid with PTFE Impregnation

Acrylic Fiber With PTFE Impregnation Square Braid Rope	3-5
550°F / 287°C Pure PTFE Square Braid	
Pure PTFE Square Braid Rope	3-6
550°F / 287°C DeltaGlass™ Fiberglass with PTFE Coated	
Fiberglass Knitted Rope with PTFE Coating: Soft Rope	3-7
Fiberglass Knitted Rope with PTFE Coating: Dense Rope	3-8
Fiberglass Twisted Rope with PTFE Coating	3-9
Fiberglass Square Braided Rope with PTFE Coating	3-10
550°F / 287°C PT-Graf™ Graphite Coated PTFE	
Square Braided Graphite Coated PTFE Rope	3-11
1200°F / 648°C DeltaGlass™ Fiberglass	
Fiberglass Knitted Rope - Premium Grade – Soft (High Compressibility)	3-12
Fiberglass Knitted Rope - Premium Grade – Dense (Low Compressibility)	3-13
Fiberglass Knitted Rope - Industrial Grade – Soft	3-14
Fiberglass Knitted Rope - Industrial Grade – Dense	3-15
Fiberglass Twisted Rope - Premium Grade	3-16
Fiberglass Braided Square Rope (Square Dry Packing) - Premium Grade	3-17
Fiberglass Compression Gasket Rope – Clip Mounting – Hollow Core	3-18
Fiberglass Braided Texturized Rope with Stainless Mesh Core	3-19
Fiberglass Braided Filament Rope with Stainless Mesh Core (Paint Shop Gaskets)	3-20
Fiberglass Rope with Wire Mesh Jacket for Kiln Door Seals	3-21
TubineSeal Jacketed Turbine Exhaust Gasket Seal	3-22
Fiberglass Rope with Graphite Coating / Impregnation: Round Soft	3-23
Fiberglass Rope with Graphite Coating / Impregnation: Round Dense	3-24
Fiberglass Braided Square Rope with Graphite Coating / Impregnation	3-25
900°F / 482°C GraphPack™ Graphite Yarn	
Fiberglass Knitted Rope - Premium Grade – Soft (High Compressibility)	3-26
1500°F / 815°C FlameShield™ 1500 Fiberglass Based with Vermiculite Coating	
Fiberglass with Vermiculite Coating Rope – Soft	3-27
Fiberglass with Vermiculite Coating Rope – Dense	3-28
Fiberglass with Vermiculite Coating Rope – Twisted	3-29
Fiberglass with Vermiculite Coating Braided Square Rope	3-30
1800°F / 982°F InSiMax™ Silica / 2000°F / 1093°F InSiMax™ XT Silica	
Silica Knitted Rope	3-31
Silica Twisted Rope	3-32
Silica Square Braided Rope	3-33
2300°F / 1260°C CerMax™ Ceramic Fiber Rope	
Ceramic Fiber Rope: Braided - Premium & Industrial Grade	3-34
Ceramic Fiber Rope: Twisted - Premium & Industrial Grade	3-35
Ceramic Fiber Rope: Square Braided - Premium & Industrial Grade	3-36
2190°F / 1200°C Stainless Steel & Inconel Mesh Rope	
304 Stainless Steel Mesh Rope	3-37
Inconel Mesh Rope	3-37

4. Fabric / Cloth / Fireblanket / Sheet

500°F / 260°C FlameShield™ Silicone Rubber Sheeting

Hot process protection pad

Silicone Rubber High Temperature & Heat Resistant Square Sheet Pad for Hot Process work	4-1
Silicone Rubber Sheet Roll	4-2

500°F / 260°C FlameShield™ Fiberglass Reinforced Silicone Rubber Sheet

AMS3320 & AMS3315

Fiberglass Reinforced Silicone Rubber Sheet – gasket and baffle material	4-3
--	-----

500°F / 260°C FlameShield™ Silicone Rubber Coated Fiberglass

Molten Metal Splash / Weld Splatter / Contamination / UV & Spark Protection

Fire Blanket / Welding Blanket / Curtain-Shield Fabric: Medium & Heavy Duty 1 - Side Coated	4-4
Fire Blanket / Welding Blanket / Curtain-Shield Fabric: Light Duty - 2 Side Coated	4-5
Fire Blanket / Welding Blanket / Curtain-Shield Fabric: Medium - 2 Side Coated	4-6
Fire Blanket / Welding Blanket / Curtain-Shield Fabric: Heavy Duty - 2 Side Coated	4-7

500°F / 260°C Dual-Coat™ Aluminum / Silicone Rubber Coated Fiberglass	
Heat Reflecting on One Side – Silicone Rubber Vapor Barrier on Opposite Side	4-8
550°F / 287°C Tuff-Flex™ Tacky Cloth Rubberized Fiberglass	
Gasket Fabric: with/without Wire Insert	4-9
550°F / 287°C DeltaGlass™ with PTFE Coating	
Fiberglass Fabric with PTFE Coating	4-10
550°F / 287°C DeltaGlass™ with PTFE Resin Impregnation & Self Adhesive	
Fiberglass Fabric with PTFE Resin Impregnation and Self Adhesive, Premium	4-11
Fiberglass Fabric with PTFE Resin Impregnation and Self Adhesive, Industrial	4-12
1200°F / 648°C DeltaGlass™ Fiberglass Based	
Fiberglass Cloth Fabric Roll – Premium Grade	4-13
Heat Treated Fiberglass Cloth Fabric Roll – Premium Grade	4-14
Weld Spatter Shield Fiberglass Cloth Fabric Roll – Premium Grade	4-15
HHP-31 Asbestos Replacement Fabric: <i>Fiberglass Fabric with Stainless Steel Wire Insert</i>	4-16
Fiberglass Cloth Fabric with Stainless Steel and Inconel Wire Insert	4-17
750°F / 399°C AraMax™ Poly-Layered Aluminum Film Coated Aramid Fabric	
Aluminum Film Coated Aramid	4-18
1000°F / 537°C MIL Spec and Standard Heat Reflective Aluminum Foil Coated	
Aluminum Foil Coated Fiberglass	4-19
1000°F / 537°C AluMax™ Poly-Layered Aluminum Film Coated Fiberglass Fabric	
Aluminum Foil Coated Fiberglass	4-20
Aluminum Foil Coated Aramid / Silica / Carbon	4-21
1000°F / 537°C DeltaGlass™ Stainless Steel Foil Coated Fiberglass Fabric	
Stainless Steel Foil Coated Fiberglass	4-22
1200°F / 648°C Basalt Rock Fiber	
Basalt Rock Fibre Fabric	4-23
1300°F / 704°C HTC Coated Wire Reinforced Fiberglass	
HTC Coated Fiberglass with Inconel Wire Reinforcement	4-24
1400°F / 760°C DeltaGlass™ S-Glass	
S-Glass Fiberglass Fabric	4-25
1500°F / 815°C FlameShield™ 1500 Fiberglass Based with Vermiculite Coating	
Fiberglass with Vermiculite Coating Blanket / Cloth / Fabric Roll	4-26
1800°F / 982°F InSiMax™ Silica with one side silicone rubber coating	
Silica Cloth Fabric	4-27
1800°F / 982°F InSiMax™ Silica	
Silica Cloth Fabric	4-28
2000°F / 1093°F InSiMax™ XT Silica	
Silica Cloth Fabric	4-29
2300°F / 1260°F AluMax™ Alumina	
Alumina Fabric	4-30
2300°F / 1260°C	
Ceramic Paper: Premium Grade	4-31
2300°F / 1260°C CerMax Ceramic Fiber	
Ceramic Cloth Fabric: Premium Grade	4-32
2300°F / 1260°C CerMax™ Ceramic Fiber	
Ceramic Cloth Fabric: Industrial Grade	4-33
950°F / 510°C to 5400°F / 2982°C GraphTek™ Graphite Sheet Roll & Laminate	
Graphite Sheet Roll: Premium Grade	4-34
1200°F / 648°C Knitted Stainless Steel / Inconel Mesh Fabric	
304 Stainless Steel Knitted Mesh Fabric, .011" wire	4-35

Inconel Knitted Mesh Fabric, .008" wire	4-36
---	------

5. Insulation Felt / Batt

500°F / 260°C

DeltaMax™ Silicone Sponge Foam Insulation	5-1
---	-----

500°F / 260°C

PyroTecton™ Nomex® Needled Insulation Felt	5-2
--	-----

500°F / 260°C

PyroTecton™ Kevlar® Aramid Needled Insulation Felt	5-3
--	-----

1100°F / 593°C

DeltaMax™ Needled Insulation – Premium Grade	5-4
--	-----

1800°F / 982°F

InSilMax™ Silica Needled Insulation: Premium Grade	5-5
--	-----

2000°F / 1093°F

InSilMax™ XT Silica Needled Insulation: Premium Grade	5-6
---	-----

1800°F / 982°F

InSilSafe™ Vitreous Silicate (Ceramic Free) Needled Insulation: Premium Grade	5-7
---	-----

2300°F / 1260°C

CerMax™ Ceramic Insulation: Premium Grade	5-8
---	-----

**6. Tuff-Wrap™ and Scuff-Sleeve™ Abrasion & Wear Resistant Sleeve & Spiral Wrap
Hose, Cable and Wire Protection**

Sleeve: Scuff-Sleeve™ Abrasion Protection Nylon and Nylon with Velcro

Nylon Abrasion Resistant Protection Braided Sleeve - .020 Monofilament	6-1
Nylon Abrasion Resistant Protection Braided Sleeve - .050 Monofilament	6-2
Nylon Abrasion Resistant Protection Sleeve, woven	6-3
Nylon Abrasion Protection Sleeve A-A-59301 & MIL-C-572	6-4
Nylon Abrasion Protection Sleeve A-A-59301 & MIL-C-572: Heavy Wall	6-5
Heavy Wall Hi-Flex, .045 Wall	6-6
Heavy Wall Pro Hi-Flex, .080 Wall	6-7
Nylon, Nylon HD and Nylon/PVC Abrasion Protection Sleeve with Velcro	6-8
Nylon HD Abrasion Protection Sleeve with Velcro Hook Loop closure	6-9
Nylon HD Abrasion Protection Sleeve with Velcro Hook Loop closure – Custom Size	6-10
PET Flexible Wrappable Split Braid Sleeve	6-11
Polyester Flexible Wrappable Split Woven Sleeve	6-12
Polyester Flexible Wrappable Split Woven Sleeve with Hook One Side	6-13
SuperGuard™ Hydraulic Blowout Protection Sleeve	6-14

Spiral Wrap: Tuff-Wrap™ Wire & Cable Abrasion Protection

Hard Shell Hose and Cable Protection Spiral Wrap	6-15
HDPE Spiral Wrap Hard Shell Hose and Cable Protection	6-16
SafeEdge™ Mine Approved Hard Shell Hose and Cable Protection MSHA IC-271	6-17
TellTale™ Spiral Wrap with Wear Indicating Layer for Hose & Cable Protection	6-18

**7. Custom Fabrications: ThermalShield™ Products
Custom Manufactured Products and Supplies**

Welding Blankets / Curtains	7-1
InSilMax Cloth Plumber / Welder Pads	7-2
InSilMax Cloth Kneeling Pads	7-3
Annealing Pads for Glass and Metal Processing	7-4
High Temperature Removable Blanket and Insulation for Engine Exhaust System Components	7-5
ExhaustGuard™ Fire Protection Removable Blanket and Shield Insulation Systems for Mine Equipment	7-11
High Temperature Removable Insulation Covers for Industrial / Marine Valves and Piping	7-12
Blow-Out / Spray Protection Shields for Valves & Pipe Flanges	7-13
Steel Mill and Metal Processing Plant Custom Fabrications: Festoon Power Track and Lift Cylinder Protection	7-14
High Temperature Removable Insulation Covers for Gas Cylinders	7-15
Heated Removable Insulation Covers & Heating Pads for Tote Tanks / Industrial Bulk Containers	7-16
55 & 30 Gallon Drum Insulated Covers & Covers with Heaters	7-17
Eco-Blanket™ Insulated Equipment Covers	7-18

Robotic Covers – Thermal / Weld Splatter Protective – Food Handling FDA Approved	7-19
High Temperature Conveyor Belts – PTFE or Silicone Coated Fabric or Porous	7-20
High Temperature Heat Resistant Sewing Threads	7-21
Filament Kevlar	7-22
Spun Kevlar	7-23
Filament & Spun Nomex	7-24
Fiberglass, Metal, Quartz	7-25
Hook & Loop Closure Fasteners	7-27
Zippers	7-30
Scissors, Shears and Cutters	7-31
Snap Hardware for Fabric Cover Shield Manufacturing	7-32
DuctSeal Fire Rated Duct Access Doors and Sealing Systems	7-33

8. Ceramic Materials

Fasteners, Crucibles, Dense Machinable Rod, Plate, Bar

Fasteners: Bolts, Nuts, Washers	8-1
Machinable Glass-Ceramic Plate & Rod, 750°F / 400°C	8-2
Machinable Glass-Ceramic Plate & Rod, 1100°F / 593°C	8-2

9. Silicone Rubber Products – High Temperature

Cured Silicone Rubber Products - Uncured Silicone Rubber Adhesives, Dip, Paint, Ink

Silicone Rubber Tubing, Premium, Oxide-Red Color	9-1
Silicone Rubber Tubing, Premium, Natural / Clear	9-2
Silicone Rubber Tubing, Premium, Oxide-Red Color, Large Diameter	9-3
Silicone Rubber Tubing, Premium, Food / Pharmaceutical / Medical Grade	9-4
Silicone Rubber STAR	9-6
Silicone Rubber Plugs; Tapered, Tapered Hollow, Straight	9-7
Silicone Rubber Adhesive, Sealant, End-Seal-Dip, Paint & Ink	9-12
Silicone Rubber Adhesive, Sealant – NSF / FDA / USDA Approved. MIL-A-46106A	9-13
Semi-Cured Silicone Rubber Bulk Compound	9-14
Silicone Rubber Extruded Profile Gasket & Seal Shapes	9-15
Silicone Rubber Electrical Strip Heaters: 5 watt per inch, 120 & 240 VAC, CSA-UL Approved	9-16
Polyimide & Silicone Rubber Flexible Strip Heaters	9-17
Silicone Rubber Drum & Pail Heaters	9-18
Silicone Rubber Heavy Duty Drum & Pail Heaters – CSA Approved	9-19
Silicone Rubber Drum Heaters – Hazardous Area Approved – T3 & T4A	9-20
Stranded Tinned Copper Wire – with High Temperature High Flexibility Silicone Rubber Extruded Jacket	9-21

10. Fire Retardants – Fire Stops – Fire Blocks – Fire Rated Wire Cable Pipe Transits

Fire Retardants & Fire / Smoke Propagation Inhibitors

FlameShield™ Fire Retardant Fabric Spray Mix	10-1
FlameShield™ Fire Rated Expanding Foam FireStop	10-2
FlameShield™ Fire Rated Acrylic Caulk FireStops	10-3
FlameShield™ Fire Rated Mortar FireStop	10-4
FlameShield™ Fire Rated Retrofit Split-Sleeve Firestop for Wire Cable Passthrough Transit	10-5

11. High Temperature Sealants / Adhesives

Silicone and Ceramic High Strength Adhesives and Sealants

SILICONE

Silicone High Temperature Sealants and Adhesives	11-1
Silica High Temperature Sealants / Adhesives	11-1

CERAMIC

Ceramic High Temperature High Strength Adhesives and Sealants	11-2
Ceramic Metallic Adhesive Paste	11-6
High Temperature Corrosion Protection Coatings –	11-8
Urethane / Epoxy –	11-8
Inorganic Ceramic with fillers	11-10
Silicone Based	11-11
Silicone-Polyester Based	11-13

High Performance Epoxies
 Ultra High Temperature
 High Temperature – Special Purpose
 High Temperature Potting
 High Temperature – Maintenance & Repair
 Ultra High Bond Strength
Ceramic Metallic Adhesive Paste 11-6

12. Metal Foils

Stainless Steel; 304 / 309 / 321 12-1

Cross-Reference Guides

Industrial Firesleeve X-1
Aero Grade Firesleeve X-2

Terms & Conditions – Account Application

Terms & Conditions F-1
Account Application F-2

Technical Notes

General

Molten Metal & Weld Splatter Protection. Silicone rubber coated materials resist molten metal splash and heavy weld splatter very well, as the molten metal does not stick to the silicone. The silicone rubber also has a high thermal dispersion index, transferring the heat at the contact area very rapidly into the surrounding area – minimizing burn-through. For applications involving only weld splatter, curtains, shields and blankets fabricated from silica materials such as cloth, tapes and ropes provide superior protection to burn-through. Plain Fiberglass materials should not be used for weld splatter burn-through protection, although vermiculite coated fiberglass with additional latex or neoprene coating provides moderate protection for light to medium weld splatter.

Premium vs. Industrial. Premium and Industrial products provide the same dimensional values in terms of width, inside diameter, thickness or wall thickness; however, Premium products are fabricated from a higher bulk yarn and with a denser weave. Premium products will weigh more and are stiffer than the Industrial version as a result. Premium can be considered a Heavy Duty version of the Industrial item. Premium tapes coated with Vermiculite will retain their pre-coat thickness better than Industrial versions, as the pinch rollers in the coating and drying process can more easily squeeze the Industrial version tapes.

Silica vs. Ceramic Fiber. With almost the same temperature range, Ceramic Fiber offers a harder/stiffer material than Silica in the same form. Ceramic based materials are typically composed of approximately 50% SiO₂ and 50% Al₂O₃ fibers while Silica based materials are almost 100% SiO₂ fibers. Ceramic based materials have a slightly higher continuous use and slightly higher excursion temperature range. Silica based materials provide burn-through protection from molten metal and weld splatter.

Silica vs. Silica XT. Standard silica products are made by starting with a fiberglass base material and then leeching the product to result in a mostly silica composition. Silica XT products are made from amorphous silica yarn, resulting in a stronger product with an enhanced temperature rating and less shrinkage.

Temperature & Application Ratings. The temperature ratings listed for these products is the maximum continuous “heat soaked” exposure. The ratings are deliberately conservative so that there will be a buffer to allow for short duration over-temperature conditions without detrimental effect or failure of the material.

For most materials, short duration exposure to considerable higher temperatures is possible. Short duration can be several minutes to an hour, and depends on the particular circumstances and installation. One of the important considerations is “heat soak” – materials with thermal inertia will withstand short-term extended temperature exposure without becoming heat soaked.

Many of our materials meet or can provide compliance to the following: U.S. Coast Guard 164.009, CAN/ULC S102-M, UL 723, ANSI/FM 4950, MIL-I-24244, ASTM E-84, ASTM C 795, ASTM E-136, NFPA 701-1999, NFPA-96 , NFPA 255, Mercury Free, ROHS complaint.

Heat Cleaning / Heat Treating. Heat Cleaning removes organic content from the fibers (burns them off). Heat Treating is a higher temperature process than Heat Cleaning, which changes the actual crystal structure of the fiber. It improves chemical resistance, anneals some of the stress inside the fiber, and improves the stiffness of the fiber.

Knitted / Woven. Knitted products, especially tapes, are more flexible and conformable than the equivalent size in a woven version.

Heat Reflecting Fiberglass with Aluminum Foil / Aluminum Coated Mylar. Aluminum foil coated fiberglass can withstand higher temperature exposure than Mylar-aluminum coated fiberglass, but the aluminum foil is subject to mechanical and abrasion breakdown with handling, flexing and vibration. It is well suited for applications such as curtains, equipment covers and exhaust system blankets. The aluminum is calendared onto the fiberglass base fabric along with an adhesive. Aluminum foil coated fiberglass can be used to temperatures up to 1000°F / 537°C, however the adhesive will smoke-off above 475°F.

Mylar is a trade name for polyester. On Fiberglass coated with Mylar-aluminum, the Mylar coating will melt and vaporize at a lower temperature than aluminum foil, but it performs better for applications such as bellows, flexible hose and cable covers, moving aperture shields, festoon covers, etc. where there is repetitive movement or flexing or abrasion. Mylar-aluminum coated fiberglass is typically suited to temperatures up to 440°F / 226°C.

Materials

PTFE Products. Polytetrafluoroethylene (PTFE) is a fluorocarbon-based polymer material (Teflon® is a branded version of PTFE from DuPont). It is hydrophobic (hates water), biologically inert, non-biodegradable and also has very low friction characteristics. The chemical inertness of PTFE is related to the strength of the fluorine-carbon bond and this is why nothing sticks to PTFE. When stretched, PTFE forms a strong porous material called expanded PTFE (ePTFE) which makes excellent mechanical sealing materials. PTFE offers an excellent temperature range of -200°C to +300°C and is suitable for both cryogenic and high temperature application.

E-glass and S-glass. Two types of fiberglass most commonly used are S-glass and E-glass. E-glass has good insulation properties and it will maintain its properties up to 1000°F (815°C) continuous use and for non tensile loaded applications up to 1200°F (648°C). S-glass has a high tensile strength and is stiffer than E-glass, and useable to 1200°F (648°C) continuous and up to 1400° (760°C) for non-tensile loaded applications.

TecPac™. TecPac is a compressed sheet, available in 1/64", 1/32", 1/16", 3/32" and 1/8" thick sheets, 60" x 60" square. It is a non-asbestos compressed sheet which has similar properties as asbestos in low temperature applications, and can be used for similar applications. It has anti-stick properties and can be used against gases, water, steam, organic acids, alkalis, aromatic and aliphatic hydrocarbons, oils, greases and refrigerants. Available cut to shape as a filler for slit and machined gaskets.

TecGraph™. TecGraph graphite laminate sheet is used for high temperature applications and offers excellent chemical resistance. Available in 1/64", 1/32", 1/16" and 1/8" thick sheets, 39.4" x 39.4" square. Purity is >98%, Ash content is <.5%, Temperature rating of 2500°C.

TecBlue™. TecBlue is a blend of polymers and reinforcing materials which provides high compressibility, conformability, heat and chemical resistance. Used in sealing glass-lined equipment in food and chemical processing. Not to be used as a primary gasket material alone – must only be used as a filler. Available in 1/16" and 1/8" thick sheet, 68" x 71" square. Available cut to shape as a filler for slit and machined gaskets.

EPDM. Ethylene Propylene. **EPDM rubber (ethylene propylene diene M-class rubber)** is an elastomer which is characterized by wide range of applications. The E refers to Ethylene, P to Propylene, D to diene and M refers to its classification in ASTM standard D-1418. The "M" class includes rubbers having a saturated chain of the polymethylene type. EPDM exhibits satisfactory compatibility with fireproof hydraulic fluids, ketones, hot and cold water, and alkalis, and unsatisfactory compatibility with most oils, gasoline, kerosene, aromatic and aliphatic hydrocarbons, halogenated solvents, and concentrated acids. The main properties of EPDM are its outstanding heat, ozone and weather resistance. The resistance to polar substances and steam are also good. It has excellent electrical properties. It has the ability to retain light colour.

VITON. Fluoroelastomer. **Viton** is a brand of synthetic rubber and fluoropolymer elastomer commonly used in O-rings and other moulded or extruded goods. The name is a registered trademark of DuPont Performance Elastomers L.L.C. The fluorine content of the most common Viton grades varies between 66 and 70%.

Tuff-Flex™ Tacky Cloth. This fiberglass material is coated with uncured white rubber and must be cured in-situ. This material must be heated to a minimum of 300°F within 60 minutes, then it must sit at 300°F or higher for 90 minutes for the rubber to fully cure. Do not over-torque the material during this curing time or the rubber will be squeezed off of the base material. If the material is not fully cured, the rubber will drip from the material causing voids. After curing the material can be exposed to a lower operational temperature..

AB Technology Group

116 Albert Street – Suite 300, Ottawa, ON K1P 5G3

Conversions:

Length: 1 Metre = 3.28 Feet 1 Metre = 1.09 Yards 1 inch = 25.4 mm 1 mm = 0.039 inches
 1 foot = 0.3048 meters 0.001 inch = 0.025 mm
Temperature: °C = (°F-32) x 5/9 °F = (°C x 9/5) + 32
Time: Seconds (Canadian) = (US) / 0.6 Seconds (US) = Seconds (Canadian) x 1.666

NEMA Grades:

For sleeves that have UL / CSA approval rating, the following NEMA grades are assigned:

NEMA Grades	
Grade	Voltage Rating
A-1	7000* volt average, 5000 volt minimum individual
B-1	4000* volt average, 2500 volt minimum individual
C-1	2500* volt average, 1500 volt minimum individual
C-2	1500* volt average, 800 volt minimum individual
C-3	No dielectric guarantee

Coated sleeving is categorized by the type of coating, base fabric material, dielectric breakdown voltage, temperature index, and inside diameter as follows:

Type 2

A flexible treated sleeving made from inorganic-base yarns such as fibrous glass and impregnated or coated with an insulating material which can be shown by applicable experience or accepted test to have at temperature index of 130 (continuous use at 130°C).

Type 3

A flexible treated sleeving made from inorganic-base yarns such as fibrous glass and impregnated or coated with an insulating material, such as polyvinyl chloride, which can be shown by applicable experience or accepted test to have a temperature index of 105 (continuous use at 105°C).

Type 4

A flexible treated sleeving made from inorganic-base yarns such as fibrous glass and impregnated or coated with an insulating material, such as silicone resin or polytetrafluoroethylene, which can be shown by applicable experience or accepted test to have a temperature index of 200 (continuous use at 200°C).

Type 5

A flexible treated sleeving made from inorganic-base yarns such as fibrous glass and impregnated or coated with an insulating material, such as silicone elastomer, which can be shown by experience or accepted test to have a temperature index of 200 (continuous use at 200°C).

Type 6

A flexible treated sleeving made from inorganic-base yarns such as fibrous glass and impregnated or coated with an insulating material, such as epoxies, polyesters, or acrylics, which can be shown by experience or accepted test to have a temperature index of 155 (continuous use at 155°C).

Sleeving Splices

Most sleeving is produced to NEMA TF 1 1993, which allows for the following maximum number of splices; 50 foot spool, 2 splices; 100 foot, 3 splices; 150 foot, 3 splices; 250 foot, 4 splices; 500 foot, 7 splices; 1000 foot, 10 splices. Please enquire if you require splice free lengths.

TradeMarks

The following are trademarks of AB Technology Group:

FlameShield™, DeltaGlass™, Thermal Protection Solutions™, Keeping Our World Cooler™, TecPac™, TecGraph™, GraphTek™, TecBlue™, SnapSleeve™, ZipSleeve™, Scuff-Sleeve™, Tuff-Flex™, Tuff-Wrap™, InSilMax™, InSulMax™, InsulDynamic™, EasyInstall™, FestoonShield™, ThermalShield™, WeaveHold™, SleeveSeal™, HoseSaver™, CableSaver™, ThermoSleeve™, ThermoTape™, ThermoRope™, ThermoTube™, CerMax™, BlackMax™, PowerTorque™, SilverGuard™, GoldGuard™, InfraShield™, ReflecSleeve™, FireFlex™, SplashGuard™ TTWearGuard™

Other trademarks are property of their respective owners.

Selecting Materials

Color Coded Pictures to Help You Choose The Correct Product
for Your Application. Need Help? Expert Advice By Phone or E-mail.

Technical Assistance: (610) 906-3549 or info@abthermal.com







				
500°F 260°C	1000°F 537°C	1500°F 537°C	2000°F 1093°C	2300°F 1260°C

Photo Boarder Color Shows Continuous Rating
with higher short exposure

Selecting Materials

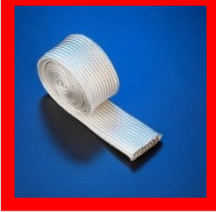
Selecting materials and designing a protection system can be assisted by understanding the kind of heat in the situation.

Ambient Heat. This is the surrounding atmospheric temperature in the area, situation or environment. For example, in an office it might be 70°F, in a firewalk it might be 2000°F.

Conductive Heat. This is the heat from direct contact with an object: picking up a hot tray from an industrial oven or kiln at 500°F or the surface of a furnace wall at 1000°F.

Radiant Heat. Objects like the Sun, or fire, or molten metal streams, glowing slabs or billets of metal radiate heat waves, which can travel through space or air or objects, and is absorbed by people or other objects. A great example is that it feels cooler standing in shade on a hot day as the shade blocks the radiant heat waves from the sun.

Molten Metal Splash or Weld Splatter. Materials with high temperature silicone rubber coating provide excellent protection from molten metal splash and weld splatter as the splash/splatter does not stick to the silicone. As well, the silicone has a high thermal dispersion, quickly dissipating the heat and preventing burn-through. The heavier or larger the splash/splatter then the heavier grade of silicone coated material should be selected.

Products & Applications: Our High Temperature Protection Materials have wide ranging application in industry, aviation, Marine and military markets. They are most commonly used in steel making, metal processing & refining, smelting, foundries, robotic welding, heat treating, steam plants, power plants (fossil and nuclear), engine and vehicle manufacturing, tire and glass manufacturing, brick & tile manufacturing, petrochemical refining, etc. In fact, any industry with a hot process, boiler, oven or kiln can use our products. It is the customers' responsibility to ensure the suitability of products to applications.

How To Order

Pricing: Prices shown are \$USD and may be subject to change without notice. Orders in other currencies may be accepted by quotation.

Accounts: Please complete our Account Application Form (available at the rear of this catalogue or on web-site) and return the form along with your standard credit reference sheet. Account application processing can take 2 to 3 business days.

New Customers: New customers may order immediately by paying via credit card, PayPal, bank wire transfer. We accept Visa, MasterCard and American Express payments by phone, fax and e-mail. Our payment gateway is PCI compliant for your information protection.

Purchase Orders: Purchase orders from established customers may be submitted verbally, by fax or by e-mail. Your PO will be acknowledged with an expected shipping date.

Verbal Orders: Call 610-906-3549. Customers accept responsibility for errors on verbal orders not confirmed by an e-mail or fax confirmation.

Minimum Order Value and Minimum Order Quantity: Minimum order value is \$50.00. Some products may have a *Minimum Order Quantity* (MOQ) such as a full spool, full coil, full carton, etc. If an order for a particular item is less than the minimum order value, then a surcharge may be applied to bring the order up to the \$50.00 minimum order value.

Most Orders Shipped Same Day: The vast majority of products are always in stock and can ship same day providing you order on-line, by fax or call by 1 PM EST. Many items can ship same day if ordered by 3PM; and some items may be available for shipping same day if ordered by 4:30 PM (may incur an expedite fee). Fabricated items require more time – please call for a fabrication quote. Tadpole Tapes, Sleeve with Velcro and Welding Curtains can typically be produced in 2 to 4 days, however it can run 5 to 10 business days for large orders or if we are particularly busy. Other fabrications with complex shapes can take up to 15 business days. Please call for an estimate.

Shipping: Unless otherwise specified, orders will be shipped UPS ground, prepaid and billed or collect on your account. Other carriers such as FedEx and USPS are available. For Dealers or Distributors, Blind or Drop shipping to your customer is available – please specify on your PO if you will be providing a Packing List and send it to us ASAP. We can also use your carrier and account if you prefer.

Customer Service Excellence: We are focused on customer service; your assurance of the correct product, quality checked & delivered on-time. All products are RoHS compliant.

AB Technology Group

CANADA Head Office: 116 Albert St, - Suite 300, Ottawa, ON K1P 5G3
USA Mail: 431 State Street Box 1491 Ogdensburg, NY 13669

Sleeve / Jacket

FlameShield™ Firesleeve; Industrial. Silicone Rubber Coated Fiberglass 500°F / 260°C	1-1
FlameShield™ Firesleeve; Aviation / Aerospace SAE AS 1072. Silicone Rubber Coated Fiberglass 500°F / 260°C	1-2
FlameShield™ Firesleeve; Marine ISO 15540 Silicone Rubber Coated Fiberglass 500°F / 260°C	1-3
Firesleeve Accessories; End Seal Dip / End Wrap Tape / Clamps / Tools	1-4
FlameShield™ Firesleeve with VELCRO® Brand Hook & Loop Closure 500°F / 260°C	1-7
Aviation Firesleeve with Hook & Loop Closure	1-9
FlameShield™ Firesleeve with Snap Closures: Silicone Rubber Coated Fiberglass Sleeve 500°F / 260°C	1-9
FlameShield™ Firesleeve with Zipper Closure: Silicone Rubber Coated Fiberglass Sleeve 500°F / 260°C	1-10
Small Diameter Firesleeve: Silicone Rubber Coated Fiberglass Sleeve with UL / CSA rating 500°F / 260°C	1-11
FlameShield™ Tuff-Flex Viton® coated small diameter sleeve 428°F / 220°C	1-13
StretchSleeve™ Silicone Rubber Coated Expandable Fiberglass Sleeve 550°F / 287°C	1-15
Fiberglass Braided Sleeve Coated with white PTFE 550°F / 287°C	1-16
ScuffSleeve™ Fiberglass Sleeve Coated w/ PTFE Resin with Velcro Closure 550°F / 287°C	1-17
FlameShield™ Braided Kevlar Sleeve 320°F / 160°C	1-18
FlameShield™ Braided Nomex Sleeve 662°F / 350°C	1-20
DeltaGlass™ Plain Fiberglass Sleeve, Premium Knit 1100°F / 593°C	1-21
DeltaGlass™ Plain Fiberglass Sleeve, Premium Braid 1100°F / 593°C	1-22
DeltaGlass™ Plain Fiberglass Sleeve, Industrial Braid 1100°F / 593°C	1-23
DeltaGlass™ Fiberglass Braided Heat Treated Sleeve 1100°F / 593°C	1-24
DeltaGlass™ Fiberglass Braided Saturated Sleeve 1100°F / 593°C	1-25
DeltaGlass™ Fiberglass Braided Precision Small Diameter Sleeve 1100°F / 593°C	1-26
DeltaGlass™ Fiberglass Braided Precision Small Diameter Sleeve, Thin Wall 1100°F / 593°C	1-31
DeltaGlass™ Fiberglass Braided Precision Small Diameter Sleeve, Acrylic Coating 1100°F / 593°C	1-32
BlackMax™ Braided Fiberglass Exhaust Pipe Sleeve 1200°F / 648°C	1-34
DeltaGlass™ Fiberglass Sleeve with Graphite Impregnation 1100°F / 593°C	1-35
DeltaGlass™ Fiberglass Sleeve with Vermiculite Coating 1500°F / 815°C	1-36
ScuffSleeve™ Specialty Weld splatter Protection Sleeve w/ Velcro Closure	1-37
InSilMax™ Braided Silica Sleeve 1800°F / 982°C	1-38
InSilMax™ Heavy Wall Braided Silica Sleeve 1800°F / 982°C	1-39
InSilMax™ XT Braided Silica Sleeve 2000°F / 1093°C	1-40
CerMax™ Braided Ceramic Fiber Sleeve 2300°F / 1260°C	1-41
ExhaustSock™ Basalt Fiber Knitted Conformable Exhaust Pipe Insulation Sleeve 1382°F / 750°C	1-42
FlameShield™ Aluminum Coated Heat Reflective Split Sleeve with Adhesive Closure – 1000°F / 537°C	1-43
FlameShield™ Aluminum Coated Heat Reflective Sleeve 1000°F / 537°C	1-44

High Temperature, Heat, Flame, Fire, Molten Metal & Weld Splatter Protection Materials

Fax Orders: 610-340-9054 Telephone Orders: 610-906-3549 orders@abthermal.com

FlameShield™ Aluminum Coated Heat Reflective Sleeve, Convoluted High Bulk 1000°F / 537°C	1-45
FlameShield™ Aluminum Coated Heat Reflective Tape Split Sleeve, Adhesive Closure 1000°F / 537°C	1-46
FlameShield™ Aluminum Foil Coated Fiberglass Heat Reflecting Sewn Sleeve 1000°F / 537°C	1-47
FlameShield™ Aluminum Film Coated Fiberglass Heat Reflecting Sewn Sleeve 1000°F / 537°C	1-48
FlameShield™ Aluminum Foil Coated Fiberglass Heat Reflecting Sewn Sleeve w/ Velcro Closure 1000°F / 537°C	1-49
FlameShield™ Aluminum Foil Coated Fiberglass Heat Reflecting Sewn Sleeve w/ Velcro Closure 1000°F / 537°C	1-50
FlameShield™ Stainless Steel Coated Fiberglass Sleeve 1000°F / 537°C	1-51
HoseSaver™ / CableSaver™ Hose Size Stainless Steel Braided Sleeve 2500°F / 1371°C	1-52
HoseSaver™ / CableSaver™ Standard Size Stainless Steel Braided Sleeve 2500°F / 1371°C	1-53
Stainless Steel Hollow Mesh Sleeve 1200°F / 648°C	1-54
Solid Wall Stainless Steel Flexible Sleeve 1200°F / 648°C	1-55
FlameShield™ EMI / RFI Shield Sleeve	1-56

DUCTING

Exhaust Hose Ducting for Metal Fabrication / Refining / Smelting / Forging 1500°F / 815°C	1-57
Exhaust Hose Ducting for Welding Applications 300°F / 148°C.....	1-58

Sleeve Size Table	1-59
-------------------------	------

Overbraiding Service	1-60
----------------------------	------

Also see Abrasion Protection Sleeve & Spiral Wrap in Section 6

High Temperature, Heat, Flame, Fire, Molten Metal & Weld Splatter Protection Materials

Fax Orders: 610-340-9054 Telephone Orders: 610-906-3549 orders@abthermal.com



Industrial & Heavy Duty
Firesleeve. Page 1-1



Aviation / Marine Grade
AS1072 Firesleeve.
Page 1-2



Firesleeve with Hook &
Loop
& EAF Cable Covers



Removable SnapSleeve™
Molten Splash Protection
Page 1-7



Removable ZipSleeve™ Molten
Splash Protection Page 1-8

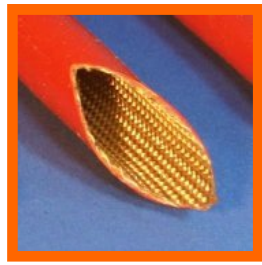

Small Diameter Thin Wall
Silicone Rubber Coated
Sleeve. Page 1-9



StretchSleeve™
Silicone Rubber Coated
Sleeve. Page 1-11



High Temperature Chemical
Resistant Sleeve.
Page 1-12



High Temperature
Chemical Resistant
Sleeve with Hook &
Loop.
Page 1-13



Kevlar Sleeve.
Page 1-14



Nomex Sleeve
Page 1-15



High Temperature Knitted /
Braided Sleeve.
Heat Treated & Saturated
Page 1-16 / 1-20



Very High Temperature
Braided Sleeve: Precision
Small Diameter.
Page 1-21 / 1-24



Very High Temperature
Sleeve with Graphite.
Page 1-25



Vermiculite Very High
Temperature Sleeve.
Page 1-26



Weld Shield Fabric Sleeve
with Hook & Loop.
Page 1-27



Extreme Temperature
Silica Sleeve
Page 1-28 / 1-29

High Temperature, Heat, Flame, Fire, Molten Metal & Weld Splatter Protection Materials

Fax Orders: 610-340-9054 Telephone Orders: 610-906-3549 orders@abthermal.com

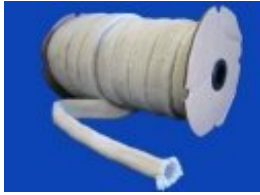

Ceramic Sleeve.
Page 1-30



Radiant Heat
Reflective Sleeves.
Page 1-31 – 1-37



Stainless Steel Braided
Sleeve & Hollow Mesh.
Page 1-38 – 1-40



Solid Wall Stainless
Steel. Page 1-41



EMI / RFI Shield
Sleeve Page 1-42



FlameShield™ Firesleeve: High Temperature, Heat, Flame, Fire & Molten Metal Resistant Protection for Hoses, Cables and Wires
500°F / 260°C Continuous Rating – Higher Temperature for Shorter Periods
Industrial Grade & Heavy Duty Grade: *Silicone Rubber Coated Fiberglass Sleeve*



Protection from:

- Heat
- Flame
- Fire
- Molten Metal Splash
- Welding Splatter & Sparks

FlameShield™ firesleeve is the standard heat, flame and fire protection for hoses, tubing, cables and wiring in harsh environments.

Utilized in most industries with hot processes, liquid metal or welding operations to protect assets and prevent failures, prolonging the life of critical hoses, wires and cables, and reduce unexpected shutdowns.

Also protects personnel from hot or cold hoses and pipes.

Firesleeve can be double sleeved or undersleeved with uncoated braided or knitted sleeves for additional thermal protection.

Industrial grade FlameShield firesleeve has minimal radial elasticity (approx 5%) while the Heavy Duty grade has approximately 20% of elasticity, allowing it to pass over couplings and connectors.

The Heavy Duty version sleeve is also used to cover water-cooled high current EAF cables and cooling water hoses at metal processing plants due to the excellent molten metal splash and slag protection. Both Industrial and Heavy Duty sleeve are extremely flexible, pliable and conformable. Used for fuel, brake, oil and hydraulic line / hose protection on mobile construction equipment, mining equipment, rail cars, buses and emergency response vehicles.

Also an excellent cold temperature sleeve with flexibility to -76°C. See further material specifications on Page 1-5.

S-FSHD up to 5" / 127mm ID meets standards: UL 1441 VW-1, DIN EN ISO 15540, EN 45545, NF F 16-101, BS 6853, NF X 10-702, NF X 70 100 & NF X 70 200, BS EN ISO 11925, BS EN ISO 4589-2, BS EN 60695-2-11, ASTM D 2863 OI, DD CEN/TS 45545-2, ASTM G85 Type 2.

Industrial Grade firesleeve is fabricated from a E-type glass yarn that is **knitted** and the Heavy Duty Grade is fabricated from a dense E-type yarn that is **braided**. Both the knitted and braided firesleeve receive a thick coating of self-extinguishing silicone rubber that withstands liquid metal splash, flame, slag, sparks, and other hazards in the toughest of environments. Standard lengths are 100 feet; specific cut lengths are available. Standard colors are Oxide-Red in all sizes for both Industrial and Heavy Duty Grades, and Black is available in sizes from -04 through -32 in Heavy Duty Grade. Other colors may be available or can be ordered in lot quantity. Use ABST-LP-1 silicone rubber paint to add color markings. Nominal wall thickness is 0.140" for S-FSHD and 0.160" for S-FS.

On March 17, 2017, AB Technology Group became the largest firesleeve manufacturer globally.

FlameShield™ Firesleeve

500°F / 260°C continuous rating with weld splatter / molten metal splash protection.
2200°F / 1205°C for periods up to 15 minutes and short excursions to 3000°F / 1650°C.

FlameShield™ High Temperature Firesleeve: Industrial grade and Heavy Duty grade								
Nominal ID Inches / mm / Dash #			Industrial Grade Part Number	Price per Foot	Price per Metre	Heavy Duty Grade Part Number	Price per Foot	Price per Metre
1/4	6	-04	S-FS-M006-04	\$ 2.96	\$ 9.68	S-FSHD-M006-04-X	\$ 3.37	\$ 11.02
5/16	8	-05	S-FS-M008-05	\$ 3.21	\$ 10.53	S-FSHD-M008-05-X	\$ 3.47	\$ 11.38
3/8	10	-06	S-FS-M010-06	\$ 3.37	\$ 11.02	S-FSHD-M010-06-X	\$ 3.68	\$ 12.03
7/16	11	-07	S-FS-M011-07	\$ 3.69	\$ 12.10	S-FSHD-M011-07-X	\$ 3.92	\$ 12.86
1/2	13	-08	S-FS-M013-08	\$ 3.97	\$ 12.98	S-FSHD-M013-08-X	\$ 4.36	\$ 14.26
9/16	15	-09	S-FS-M015-09	\$ 4.21	\$ 13.80	S-FSHD-M015-09-X	\$ 4.53	\$ 14.86
5/8	16	-10	S-FS-M016-10	\$ 4.34	\$ 14.19	S-FSHD-M016-10-X	\$ 4.67	\$ 15.32
11/16	17	-11	S-FS-M017-11	\$ 4.63	\$ 15.18	S-FSHD-M017-11-X	\$ 5.07	\$ 16.63
3/4	19	-12	S-FS-M019-12	\$ 4.88	\$ 15.96	S-FSHD-M019-12-X	\$ 5.34	\$ 17.52
13/16	20	-13	S-FS-M020-13	\$ 5.55	\$ 18.20	S-FSHD-M020-13-X	\$ 5.94	\$ 19.48
7/8	22	-14	S-FS-M022-14	\$ 5.82	\$ 19.03	S-FSHD-M022-14-X	\$ 6.33	\$ 20.76
1	25	-16	S-FS-M025-16	\$ 6.42	\$ 21.06	S-FSHD-M025-16-X	\$ 7.19	\$ 23.58
1 1/8	29	-18	S-FS-M029-18	\$ 7.25	\$ 23.78	S-FSHD-M029-18-X	\$ 8.12	\$ 26.63
1 1/4	32	-20	S-FS-M032-20	\$ 7.76	\$ 25.45	S-FSHD-M032-20-X	\$ 8.68	\$ 28.47
1 3/8	35	-22	S-FS-M035-22	\$ 7.81	\$ 25.62	S-FSHD-M035-22-X	\$ 8.75	\$ 28.70
1 1/2	38	-24	S-FS-M038-24	\$ 8.04	\$ 26.37	S-FSHD-M038-24-X	\$ 9.01	\$ 29.55
1 5/8	41	-26	S-FS-M041-26	\$ 8.17	\$ 26.80	S-FSHD-M041-26-X	\$ 9.14	\$ 29.98
1 3/4	44	-28	S-FS-M044-28	\$ 10.43	\$ 34.21	S-FSHD-M044-28-X	\$ 11.68	\$ 38.31
1 7/8	48	-30	S-FS-M048-30	\$ 11.50	\$ 37.72	S-FSHD-M048-30-X	\$ 13.63	\$ 44.71
2	51	-32	S-FS-M051-32	\$ 12.18	\$ 39.95	S-FSHD-M051-32-X	\$ 16.23	\$ 53.23
2 1/4	57	-36	S-FS-M057-36	\$ 14.49	\$ 47.53	S-FSHD-M057-36	\$ 18.67	\$ 61.24
2 3/8	60	-38	S-FS-M060-38	\$ 16.79	\$ 55.07	S-FSHD-M060-38	\$ 19.93	\$ 65.37
2 1/2	64	-40	S-FS-M064-40	\$ 18.83	\$ 61.76	S-FSHD-M064-40	\$ 21.10	\$ 69.21
2 5/8	67	-42	S-FS-M067-42	\$ 21.45	\$ 70.36	S-FSHD-M067-42	\$ 23.87	\$ 78.29
2 3/4	70	-44	S-FS-M070-44	\$ 24.11	\$ 79.08	S-FSHD-M070-44	\$ 24.45	\$ 80.20
2 7/8	73	-46	S-FS-M073-46	\$ 25.91	\$ 84.98	S-FSHD-M073-46	\$ 29.24	\$ 95.91
3	76	-48	S-FS-M076-48	\$ 27.21	\$ 89.25	S-FSHD-M076-48	\$ 29.98	\$ 98.33
3 1/4	83	-52	S-FS-M083-52	\$ 29.14	\$ 95.58	S-FSHD-M083-52	\$ 30.17	\$ 98.96
3 1/2	89	-56	S-FS-M089-56	\$ 31.26	\$ 102.53	S-FSHD-M089-56	\$ 31.94	\$ 104.76
3 3/4	95	-60	S-FS-M095-60	\$ 32.34	\$ 106.08	S-FSHD-M095-60	\$ 32.63	\$ 107.03
4	102	-64	S-FS-M102-64	\$ 32.65	\$ 107.09	S-FSHD-M102-64	\$ 33.83	\$ 110.96
4 1/2	114	-72	S-FS-M114-72	\$ 44.24	\$ 145.11	S-FSHD-M114-72	\$ 39.55	\$ 129.56
5	127	-80	S-FS-M127-80	\$ 47.92	\$ 157.18	S-FSHD-M127-80	\$ 42.53	\$ 139.51
5 1/2	140	-87	S-FS-M140-87	\$ 52.71	\$ 172.88	S-FSHD-M140-87	\$ 44.96	\$ 147.47
6	152	-96	S-FS-M152-96	\$ 57.50	\$ 188.60	S-FSHD-M152-96	\$ 47.03	\$ 154.26
8	203	-128	S-FS-M203-128	\$ 76.19	\$ 249.90	S-FSHD-M203-128	\$ 67.62	\$ 221.79
10	254	-160	S-FS-M254-160	\$ 95.84	\$ 314.35	S-FSHD-M254-160	\$ 85.06	\$ 278.99
12	305	-193	S-FS-M305-193	\$ 115.00	\$ 377.20	S-FSHD-M305-193	\$ 102.07	\$ 334.79
14	356	-225	S-FS-M356-225	\$ 134.17	\$ 440.07	S-FSHD-M356-225	\$ 119.08	\$ 390.58
16	406	-257	S-FS-M406-257	\$ 153.34	\$ 502.95	S-FSHD-M406-257	\$ 136.09	\$ 446.37

- For 6" ID and larger, the size is customizable - the sizes shown above in the table are example sizes and pricing. Sizes up to 120" ID are available - Priced by quotation.
- On-site custom fabrication over non-moveable or non-disconnectable hoses and pipes is available.

Standard color is Oxide-Red - other colors such as Black, Silver/Grey, Yellow, Green and Blue are available. Add the color code after the part number.
For the "-X" value above in the part number use "-OR" for Oxide-Red or "-BK" for Black

Sizes up to 5" ID are available By-The-Foot / Metre or in standard 100 foot / 30 metre lengths
Larger diameters up to 6" ID may also be available in 50 foot / 15 metre lengths



SAE AS1072 Aviation / Aerospace Firesleeve: High Temperature, Heat, Flame & Fire Resistant - without markings - Oxide-Red and Black
500°F / 260°C Continuous Rating – Higher Temperature for Shorter Periods
Aviation / Aerospace Grade: Meets SAE AS1072 - Silicone Rubber Coated Fiberglass Sleeve



FlameShield™ Aviation / Aerospace grade firesleeve allows properly assembled hose assemblies to meet SAE AS1055D testing. We also maintain traceability records for customers buying this product. 500°F / 260°C continuous rating and with a 15 minute FAA “Fireproof” rating when assembled according to SAE AS1055.

This sleeve is extremely flexible, pliable and conformable. Typically used to protect fuel, oil, hydraulic lines and hoses, as well as critical wiring and cables. Remains flexible to -76°C (-104.8°F).

Firesleeve must be cut slightly longer than the hose or cable it is covering so it covers part of the fitting or connector. The longer the hose or cable, and if tight fitting, or if in use the hose/cable will be curved, then the longer the firesleeve needs to be. Firesleeve that is short will pull back from the fitting when the hose is bent, and if this occurs the hose assembly won't meet the TSO. Appropriate clamps must be used over the firesleeve at the fitting for aviation and Marine applications. (See our clamps and tools)

This sleeve has a radial elasticity of approximately 15% allowing it to slide over connectors, fittings and splices.

See further specifications on Page 1-6.

FlameShield™ S-AS1072 firesleeve also meets the following standards: UL 1441 VW-1, DIN EN ISO 15540, EN 45545, NF F 16-101, BS 6853, NF X 10-702, NF X 70 100 & NF X 70 200, BS EN ISO 11925, BS EN ISO 4589-2, BS EN 60695-2-11, ASTM D 2863 OI, DD CEN/TS 45545-2, ASTM G85 Type 2.

500°F / 260°C continuous rating, 800°F / 426°C for periods up to 30 minutes
2200°F / 1205°C for periods up to 15 minutes and short excursions to 3000°F / 1650°C.

FlameShield™ AS1072 Aviation / Aerospace Grade Firesleeve									
Nominal ID Inches / mm / Dash #			Part Number	Price per Foot / Metre	Nominal ID Inches / mm / Dash #			Part Number	Price per Foot / Metre
1/4	6	-04	S-AS1072-M006-04-X	\$ 3.54 / \$ 11.61	1 7/8	48	-30	S-AS1072-M048-30-X	\$ 14.99 / \$ 49.17
3/8	10	-06	S-AS1072-M010-06-X	\$ 3.86 / \$ 12.66	2	51	-32	S-AS1072-M051-32-X	\$ 17.85 / \$ 58.55
7/16	11	-07	S-AS1072-M011-07-X	\$ 4.36 / \$ 14.30	2 1/4	57	-36	S-AS1072-M057-36	\$ 20.54 / \$ 67.37
1/2	13	-08	S-AS1072-M013-08-X	\$ 4.62 / \$ 15.15	2 1/2	64	-40	S-AS1072-M064-40	\$ 23.21 / \$ 76.13
9/16	15	-09	S-AS1072-M015-09-X	\$ 4.88 / \$ 16.01	2 5/8	67	-42	S-AS1072-M067-42	\$ 26.26 / \$ 86.13
5/8	16	-10	S-AS1072-M016-10-X	\$ 5.13 / \$ 16.83	2 3/4	70	-44	S-AS1072-M070-44	\$ 26.89 / \$ 88.20
3/4	19	-12	S-AS1072-M019-12-X	\$ 5.87 / \$ 19.25	2 7/8	73	-46	S-AS1072-M073-46	\$ 30.56 / \$ 100.24
7/8	22	-14	S-AS1072-M022-14-X	\$ 6.96 / \$ 22.83	3	76	-48	S-AS1072-M076-48	\$ 32.39 / \$ 106.24
1	25	-16	S-AS1072-M025-16-X	\$ 7.90 / \$ 25.91	3 1/4	83	-52	S-AS1072-M083-52	\$ 32.91 / \$ 107.95
1 1/8	29	-18	S-AS1072-M029-18-X	\$ 8.93 / \$ 29.29	3 1/2	89	-56	S-AS1072-M089-56	\$ 35.13 / \$ 115.23
1 1/4	32	-20	S-AS1072-M032-20-X	\$ 9.55 / \$ 31.32	3 3/4	95	-60	S-AS1072-M095-60	\$ 35.89 / \$ 117.72
1 3/8	35	-22	S-AS1072-M035-22-X	\$ 9.63 / \$ 31.59	4	102	-64	S-AS1072-M102-64	\$ 37.21 / \$ 122.05
1 1/2	38	-24	S-AS1072-M038-24-X	\$ 9.90 / \$ 32.47	4 1/2	114	-72	S-AS1072-M114-72	\$ 42.72 / \$ 140.12
1 5/8	41	-26	S-AS1072-M041-26-X	\$ 10.05 / \$ 32.96	5	127	-80	S-AS1072-M127-80	\$ 46.83 / \$ 153.60
1 3/4	44	-28	S-AS1072-M044-28-X	\$ 12.85 / \$ 42.15					

For the “-X” value above in the part number, use “-OR” for Oxide-Red or “-BK” for Black

AS1072 Aerospace grade firesleeve is fabricated from a dense E-type braided sleeve and then receives a thick coating of self-extinguishing silicone rubber that withstands flame exposure, allowing qualified hose assemblies to meet FAA TSO-C42 (Propeller feathering hose assemblies), TSO-C53a (Fuel and Oil system hose assemblies) and TSO-C75 (Hydraulic hose assemblies). Standard lengths are 100 feet; specific cut lengths are available. Standard color is Oxide-Red in all sizes and Black is available in sizes -04 through -32. Nominal wall thickness is 0.16”.

This product is available By-The-Foot / Metre or in standard 100 foot / 30 metre lengths
Larger sizes available in 50 foot / 15 metre lengths

SAE AS1072 Aviation / Aerospace Firesleeve: High Temperature, Heat, Flame & Fire Resistant Type 2 Silicone Rubber Composite

500°F / 260°C Continuous Rating – Higher Temperature for Shorter Periods



FlameShield™ Aviation / Aerospace grade firesleeve is manufactured to the SAE AS1072 specification. CofC and Test Report available with orders. Our company QMS has been reviewed and accepted by major aerospace OEMs. Allows properly assembled hose assemblies to meet SAE AS1055D testing. We also maintain traceability records for customers buying this product. 500°F / 260°C continuous rating and with a 15 minute FAA “Fireproof” rating when assembled according to SAE AS1055.

This sleeve is extremely flexible, pliable and conformable. Typically used to protect fuel, oil, hydraulic lines and hoses, as well as critical wiring and cables. Remains flexible to -76°C (-104.8°F).

Firesleeve must be cut slightly longer than the hose or cable it is covering so it covers part of the fitting or connector. The longer the hose or cable, and if tight fitting, or if in use the hose/cable will be curved, then the longer the firesleeve needs to be. Firesleeve that is short will pull back from the fitting when the hose is bent, and if this occurs the hose assembly won't meet the TSO. Appropriate clamps must be used over the firesleeve at the fitting for aviation and Marine applications. (See our clamps and tools)

This sleeve has a radial elasticity of approximately 15% allowing it to slide over connectors, fittings and splices.

For further specifications see Technical Data page 1-6. This sleeve is marked per the AS1072 specification. Other markings such as tradenames may be added.

FlameShield™ S-AS1072 firesleeve is also compliant to the following standards: UL 1441 VW-1, DIN EN ISO 15540, EN 45545, NF F 16-101, BS 6853, NF X 10-702, NF X 70 100 & NF X 70 200, BS EN ISO 11925, BS EN ISO 4589-2, BS EN 60695-2-11, ASTM D 2863 OI, DD CEN/TS 45545-2, ASTM G85 Type 2.

500°F / 260°C continuous rating, 800°F / 426°C for periods up to 30 minutes
2200°F / 1205°C for periods up to 15 minutes and short excursions to 3000°F / 1650°C.

FlameShield™ SAE AS1072 Aviation / Aerospace Grade Firesleeve with Marking

Nominal ID Inches / mm / Dash #			Part Number	Price per Foot / Metre	Nominal ID Inches / mm / Dash #			Part Number	Price per Foot / Metre
1/4	6	-04	AS1072-04 SIL-FG	\$ 3.99 / \$ 13.09	1 3/4	44	-28	AS1072-28 SIL-FG	\$ 13.88 / \$ 45.52
5/16	8	-05	AS1072-05 SIL-FG	\$ 4.17 / \$ 13.66	1 7/8	48	-30	AS1072-30 SIL-FG	\$ 16.19 / \$ 53.10
3/8	10	-06	AS1072-06 SIL-FG	\$ 4.34 / \$ 14.24	2	51	-32	AS1072-32 SIL-FG	\$ 19.28 / \$ 63.23
7/16	11	-07	AS1072-07 SIL-FG	\$ 4.88 / \$ 16.01	2 1/4	57	-36	AS1072-36 SIL-FG	\$ 22.18 / \$ 72.76
1/2	13	-08	AS1072-08 SIL-FG	\$ 5.16 / \$ 16.92	2 3/8	60	-38	AS1072-38 SIL-FG	\$ 23.63 / \$ 77.51
9/16	15	-09	AS1072-09 SIL-FG	\$ 5.44 / \$ 17.84	2 1/2	64	-40	AS1072-40 SIL-FG	\$ 25.07 / \$ 82.22
5/8	16	-10	AS1072-10 SIL-FG	\$ 5.71 / \$ 18.73	2 5/8	67	-42	AS1072-42 SIL-FG	\$ 28.36 / \$ 93.02
11/16	17	-11	AS1072-11 SIL-FG	\$ 6.11 / \$ 20.04	2 3/4	70	-44	AS1072-44 SIL-FG	\$ 29.04 / \$ 95.26
3/4	19	-12	AS1072-12 SIL-FG	\$ 6.51 / \$ 21.35	2 7/8	73	-46	AS1072-46 SIL-FG	\$ 33.01 / \$ 108.26
13/16	20	-13	AS1072-13 SIL-FG	\$ 7.11 / \$ 23.32	3	76	-48	AS1072-48 SIL-FG	\$ 34.98 / \$ 114.74
7/8	22	-14	AS1072-14 SIL-FG	\$ 7.69 / \$ 25.22	3 1/4	83	-52	AS1072-52 SIL-FG	\$ 35.54 / \$ 116.58
1	25	-16	AS1072-16 SIL-FG	\$ 8.70 / \$ 28.54	3 1/2	89	-56	AS1072-56 SIL-FG	\$ 37.94 / \$ 124.44
1 1/8	29	-18	AS1072-18 SIL-FG	\$ 9.55 / \$ 31.32	3 3/4	95	-60	AS1072-60 SIL-FG	\$ 38.76 / \$ 127.14
1 1/4	32	-20	AS1072-20 SIL-FG	\$ 10.48 / \$ 34.37	4	102	-64	AS1072-64 SIL-FG	\$ 40.19 / \$ 131.81
1 3/8	35	-22	AS1072-22 SIL-FG	\$ 11.33 / \$ 37.16	4 1/2	114	-72	AS1072-72 SIL-FG	\$ 46.14 / \$ 151.33
1 1/2	38	-24	AS1072-24 SIL-FG	\$ 12.18 / \$ 39.95	5	127	-80	AS1072-80 SIL-FG	\$ 50.58 / \$ 165.89
1 5/8	41	-26	AS1072-26 SIL-FG	\$ 13.03 / \$ 42.74	6	162	-96	AS1072-96 SIL-FG	\$ 60.69 / \$ 199.08

SAE AS1072 Aerospace grade firesleeve is fabricated from a dense E-type braided sleeve and then receives a thick coating of self-extinguishing silicone rubber that withstands flame exposure, allowing qualified hose assemblies to meet FAA TSO-C42 (Propeller feathering hose assemblies), TSO-C53a (Fuel and Oil system hose assemblies) and TSO-C75 (Hydraulic hose assemblies). Standard lengths are 100 feet; specific cut lengths are available. Standard color is Oxide-Red with black printing. Black sleeve with white printing is available. Other colors available.

**This product is available By-The-Foot / Metre or in standard 100 foot / 30 metre lengths
Larger sizes available in 50 foot / 15 metre lengths**



DIN EN ISO15540 Marine Grade Firesleeve: High Temperature, Heat, Flame & Fire Resistant

500°F / 260°C Continuous Rating - 800°F / 426°C For Up To 30 Minutes

Marine Grade - Meets DIN EN ISO 15540 / USCG / SOLAS

Silicone Rubber Coated Fiberglass Sleeve



FlameShield™ Marine grade firesleeve allows properly assembled hose assemblies to meet ISO 15540 testing. We also maintain traceability records for customers buying this product. 500°F / 260°C continuous rating and with a 30 minute "Fireproof" 800°F / 426°C rating.

This sleeve is extremely flexible, pliable and conformable. Typically used to protect fuel, oil, hydraulic lines and hoses, as well as critical wiring and cables. Remains flexible to -76°C (-104.8°F).

Firesleeve must be cut slightly longer than the hose or cable it is covering so it covers part of the fitting or connector. The longer the hose or cable, and if tight fitting, or if in use the hose/cable will be curved, then the longer the firesleeve needs to be. Firesleeve that is short will pull back from the fitting when the hose is bent, and if this occurs the hose assembly won't meet the ISO standard. Appropriate clamps must be used over the firesleeve at the fitting for aviation and Marine applications. (See our clamps and tools)

This sleeve has a radial elasticity of approximately 15% allowing it to slide over connectors, fittings and splices.

S-ISO15540 also meets the following standards: UL 1441 VW-1, EN 45545, NF F 16-101, BS 6853, NF X 10-702, NF X 70 100 & NF X 70 200, BS EN ISO 11925, BS EN ISO 4589-2, BS EN 60695-2-11, ASTM D 2863 OI, DD CEN/TS 45545-2, ASTM G85 Type 2.

**500°F / 260°C continuous rating, 800°F / 426°C for periods up to 30 minutes
2200°F / 1205°C for periods up to 15 minutes and short excursions to 3000°F / 1650°C.**

FlameShield™ DIN EN ISO15540 Marine Grade Firesleeve									
Nominal ID Inches / mm / Dash #			Part Number	Price per Foot / Metre	Nominal ID Inches / mm / Dash #			Part Number	Price per Foot / Metre
1/4	6	-04	S-ISO15540-M006-04-X	\$ 3.54 / \$ 11.61	1 7/8	48	-30	S-ISO15540-M048-30-X	\$ 14.99 / \$ 49.17
3/8	10	-06	S-ISO15540-M010-06-X	\$ 3.86 / \$ 12.66	2	51	-32	S-ISO15540-M051-32-X	\$ 17.85 / \$ 58.55
7/16	11	-07	S-ISO15540-M011-07-X	\$ 4.36 / \$ 14.30	2 1/4	57	-36	S-ISO15540-M057-36	\$ 20.54 / \$ 67.37
1/2	13	-08	S-ISO15540-M013-08-X	\$ 4.62 / \$ 15.15	2 1/2	64	-40	S-ISO15540-M064-40	\$ 23.21 / \$ 76.13
9/16	15	-09	S-ISO15540-M015-09-X	\$ 4.88 / \$ 16.01	2 5/8	67	-42	S-ISO15540-M067-42	\$ 26.26 / \$ 86.13
5/8	16	-10	S-ISO15540-M016-10-X	\$ 5.13 / \$ 16.83	2 3/4	70	-44	S-ISO15540-M070-44	\$ 26.89 / \$ 88.20
3/4	19	-12	S-ISO15540-M019-12-X	\$ 5.87 / \$ 19.25	2 7/8	73	-46	S-ISO15540-M073-46	\$ 30.56 / \$ 100.24
7/8	22	-14	S-ISO15540-M022-14-X	\$ 6.96 / \$ 22.83	3	76	-48	S-ISO15540-M076-48	\$ 32.39 / \$ 106.24
1	25	-16	S-ISO15540-M025-16-X	\$ 7.90 / \$ 25.91	3 1/4	83	-52	S-ISO15540-M083-52	\$ 32.91 / \$ 107.95
1 1/8	29	-18	S-ISO15540-M029-18-X	\$ 8.93 / \$ 29.29	3 1/2	89	-56	S-ISO15540-M089-56	\$ 35.13 / \$ 115.23
1 1/4	32	-20	S-ISO15540-M032-20-X	\$ 9.55 / \$ 31.32	3 3/4	95	-60	S-ISO15540-M095-60	\$ 35.89 / \$ 117.72
1 3/8	35	-22	S-ISO15540-M035-22-X	\$ 9.63 / \$ 31.59	4	102	-64	S-ISO15540-M102-64	\$ 37.21 / \$ 122.05
1 1/2	38	-24	S-ISO15540-M038-24-X	\$ 9.90 / \$ 32.47	4 1/2	114	-72	S-ISO15540-M114-72	\$ 42.72 / \$ 140.12
1 5/8	41	-26	S-ISO15540-M041-26-X	\$ 10.05 / \$ 32.96	5	127	-80	S-ISO15540-M127-80	\$ 46.83 / \$ 153.60
1 3/4	44	-28	S-ISO15540-M044-28-X	\$ 12.85 / \$ 42.15					

For the "-X" value above in the part number, use "-OR" for Oxide-Red or "-BK" for Black

ISO15540 Marine grade firesleeve is fabricated from a dense E-type braided sleeve and then receives a thick coating of self-extinguishing silicone rubber that withstands flame exposure, allowing qualified hose assemblies to meet DIN EN ISO 15560 for fuel and lubricating oil marine systems.

Standard lengths are 100 feet; specific cut lengths are available. Standard color is Oxide-Red in all sizes and Black is available in sizes -04 through -32. Nominal wall thickness is 0.16".

**This product is available By-The-Foot / Metre or in standard 100 foot / 30 metre lengths
Larger sizes available in 50 foot / 15 metre lengths**

FlameShield™ Firesleeve Technical Data For Part Numbers S-FS / S-FSHD / S-AS1072 / S-ISO15540

Base Fiberglass Substrate – All Versions

Fiber Type:	E Glass
Specific Gravity:	2.54-2.69
Breaking Tenacity:	1.71 gf/TEX. Std. 1.71 gf/TEX Wet
Tensile Strength:	450,000-500,000 psi.
Breaking Elongation:	4.81% Std. 4.81% Wet
Elastic Recovery:	100%
Average Stiffness:	2824.3 cn/TEX

Effect of Heat: Will not burn; Retains 75% tensile at 343°C; Softens at 732-877°C; Melts at 1121-1182°C.
Effect of Acids and Alkalis; Resistance to acids is fair. Good resistance to most alkalis.
Effect of Bleaches and Solvents: Unaffected.

Silicone Rubber Coating – All Versions

Durometer, Shore A:	Initial; 35	Aged 240 hours @ 200°C; 45
Tensile Strength (psi):	Initial; 875	Aged 240 hours @ 200°C; 800
Elongation %:	Initial; 500	Aged 240 hours @ 200°C; 200
Flammability, UL94; V-1		
Dielectric Strength (volts/mil); 485		

Elasticity

S-FSHD: Linear elasticity of approximately 2% and a radial elasticity of approximately 15%.
S-FS: Linear elasticity of approximately 2% and a radial elasticity of approximately 2%.

S-FSHD / S-AS1072 / S-ISO15540 sleeve meeting SAE AS1072 & DIN EN ISO15540 Specifications; Additional Data

Coating Thickness

AS1072 Specification: Minimum: .03" (0.8mm)

Fluid Resistance

Phosphate Ester hydraulic fluids	MIL-H-5606 hydraulic fluid
MIL-T-5624 Jet Fuel	MIL-L-6082 lubricating oil
MIL-L-7808 lubricating oil	MIL-L-23699 lubricating oil
MIL-H-83282 hydraulic fluid	

UL 1441 VW-1, EN 45545, NF F 16-101, BS 6853, NF X 10-702, NF X 70 100 & NF X 70 200, BS EN ISO 11925, BS EN ISO 4589-2, BS EN 60695-2-11, ASTM D 2863 OI, DD CEN/TS 45545-2, ASTM G85 Type 2.

Printed/Marked Sleeve Options

FlameShield™ SAE AS1072 firesleeve is available unmarked but package labelled with the SAE nomenclature, or with SAE standard marking. Sleeve can also be printed/marked with other identification, part numbers, instructions, warnings, etc. Non standard SAE marking cost of an etched print wheel is \$275.00. A setup charge of \$75.00 per print run applies. Cost of printing is \$0.25 per foot. Standard SAE marking is \$0.20 per foot.





End Dip & End Seal Paste for Firesleeve Sealing

High Temperature & Heat Resistant Sealant For Industrial, Heavy Duty, Aerospace, Marine Grade Firesleeve



SleeveSeal™

End Seal Dip – Liquid Silicone Rubber
End Seal Paste – Silicone Rubber RTV

The ends of firesleeve can be sealed against the absorption of liquids by dipping the end in this liquid silicone rubber end dip sealant or by using end seal paste.

Available in any color: Oxide-Red and Black are the most common (other colors 1 gallon minimum).

Becomes tack free in 60 to 90 minutes and cures fully in 16 to 24 hours*. Cure can be accelerated by increasing relative humidity and also adding heat.

500°F / 260°C rating once cured. Non-hazardous to ship. Liquid End Seal Dip may be thinned with odourless mineral spirits (xylene). Non corrosive and meets Mil-A-46146 as per NAVAIR 01-1A-20.

The 4 oz mini container opening can accommodate sleeve up to 1 3/4" ID.

The 16 oz container opening can accommodate sleeve up to 3 1/4" ID.

A Low VOC version is available: Maximum VOC is 20g/L.

SleeveSeal™ High Temperature Liquid End Seal Dip and End Seal Paste		
Quantity	Part Number	Price
Liquid End Seal Dip		
4 oz	US-ESD-04-XX	\$ 21.76
16 oz (Pint)	US-ESD-16-XX	\$ 46.47
32 oz (Quart)	US-ESD-32-XX	\$ 87.20
128 oz (1 gallon)	US-ESD-128-XX	\$ 229.32
128 oz (1 gallon)	US-ESD-LV-128-XX*	\$ 281.08
640 oz (5 gallon)	US-ESD-640-XX	\$ 988.40
End Seal Paste		
3 oz tube	US-ESP-03-XX	\$ 19.83
10.3 oz cartridge	US-ESP-10-XX	\$ 38.47
Desiccant Box		
1.5oz Desiccant in Box	AB-SGD-1	\$ 12.87

XX = "OR" for oxide-red or "BK" for black. Other colors are available for the Dip: min quantity is 1 gallon.

* = Low VOC version.

Desiccant Box



Desiccant box can be placed with uncured SleeveSeal™ Dip container in a sealed container or bag to considerably extend shelf life. Can be re-generated for unlimited re-use.

Perforated plastic box is approx 2 1/4" x 2 1/4" x 1". Total weight is 2.3oz (67g). Can be recharged at low temperature in an oven or microwave. Dry desiccant is blue in color and changes to pink as it absorbs moisture.

Firesleeve End Wrap Tape / High Temperature Electrical Tape 500°F/260°C
Silicone Rubber Self Fusing / Self Binding / Self Amalgamating Compression Tape



FlameShield™ end wrap & electrical amalgamating compression tape is a unique adhesive-free tape which self-fuses / self-bonds within 24 hours or less at room temperature or shorter time at elevated temperatures when wrapped over itself, providing an excellent water-tight and air-tight seal.

Tape is adhesive free; leaves no residue when removed. Typically used to protect the free ends of firesleeve from wicking liquids once installed on hoses or cables. Also used for electrical wire and cable splice protection and protection of wires at connector shell clamp band locations. Exceptional electrical insulation resistance in a single wrap.

Tested to:

- ASTM D 149; tested for minimum 400 V/mil. for .010" to .030" thick tape, 300 V/mil for .040" thick tape and 250 V/mil for .060" thick tape.
- ASTM D 412; tested for minimum 700 psi tensile strength and minimum 300% elongation.
- ASTM D 2240; Durometer (Shore A); 55. Other test data available.

Using triangular profile tapes results in a smooth surface contour when spiral wrapped. The most common tapes are 1" wide triangular profile with either a 0.020" or 0.040" center thickness. Meets Mil-I-46852C & A-A-59163 specifications. Triangular tapes have a center guideline to aid in properly spacing the tape when spiral wrapping. T-SR-SA25 tape meets MIL-I-22444 and provides uniform thickness even on sharp corners and edges.

Tape part numbers ending in "BK" are Black color; "OR" are Oxide-Red color. Other colors are available by custom run.

FlameShield™ High Temperature Silicone Self Fusing Firesleeve End Wrap Tape				
Meets MIL-I-46852 / A-A-59163 / ABS 5334 Specifications - Type I and Type II				
Part Number	Tape Width Inches / mm	Thickness inches / mm	Color / Type / Profile	Single Roll Price Per Roll
T-SR-M013-08-RBK-20	1/2 / 12.7	0.020 / 0.508	Black / I / Rectangular	\$ 29.37
T-SR-M013-08-RXX-30	1/2 / 12.7	0.030 / 0.760	Black or Red / I / Rectangular	\$ 37.16
T-SR-M016-10-RBK-20	5/8 / 15.7	0.020 / 0.508	Black / I / Rectangular	\$ 30.17
T-SR-M019-12-ROR-10	3/4 / 19	0.010 / 0.254	Oxide-Red / I / Rectangular	\$ 23.85
T-SR-M019-12-RBK-20	3/4 / 19	0.020 / 0.508	Black / I / Rectangular	\$ 31.96
T-SR-M025-16-TXX-20	1 / 25.4	0.020 / 0.508	Black or Red / II / Triangular	\$ 33.80
T-SR-M025-16-RXX-20	1 / 25.4	0.020 / 0.508	Black or Red / I / Rectangular	\$ 34.71
T-SR-M025-16-TXX-40	1 / 25.4	0.040 / 1.000	Black or Red / II / Triangular	\$ 37.91
T-SR-M025-16-RXX-40	1 / 25.4	0.040 / 1.000	Black or Red / I / Rectangular	\$ 39.64
T-SR-M038-24-RXX-20	1 1/2 / 38.1	0.020 / 0.508	Black or Red / I / Rectangular	\$ 48.77
T-SR-M038-24-RXX-12	1 1/2 / 38.1	0.012 / 0.304	Black or Red / I / Rectangular	\$ 38.47
T-SR-M051-32-RXX-20	2 / 50.8	0.020 / 0.508	Black or Red / I / Rectangular	\$ 57.13
T-SR-M051-32-TXX-20	2 / 50.8	0.020 / 0.508	Black or Red / II / Triangular	\$ 48.86
Triangular Type II Tapes Only: .020" has a blue guideline / .040" has a green guideline				

Supported Tape with Limited Elongation				
Meets MIL-I-22444 (also meets MIL-I-46852 / A-A-59163 / ABS 5334 Specifications)				
Part Number	Tape Width Inches / mm	Thickness inches / mm	Color / Type / Profile	Single Roll Price Per Roll
T-SR-SA25-16-20-RBK*	1 / 25.4	0.020 / 0.508	Black / I / Rectangular	\$ 67.29
T-SR-SA25-16-20-ROR*	1 / 25.4	0.020 / 0.508	Red / I / Rectangular	\$ 67.29

* NOTE: T-SR-SA25-16-20-RBK & T-SR-SA25-16-20-ROR tape has an encapsulated sinusoidal weave fiberglass reinforcement layer, limiting stretch of the tape to a maximum of 25%, ensuring that the tape thickness remains constant over irregular surfaces and edges.

A Certificate of Conformity is available at \$6.00 per roll or \$25.00 per line item / batch-lot. Test report is available at \$75.00 per line item. This tape is also available meeting several other OEM and National Stock Number / NATO Stock Number specifications (available under military cage code is L8347).

These tapes are guaranteed to meet specification for 1 year from date of manufacture providing tapes are stored dry at 21°C +/- 3°C or 70°F +/- 5°F. Standard tapes have an interleaved liner of polyethylene (Mylar®). Polyester liner available.

Firesleeve Stainless Steel Preformed Twice Around Clamps

Type 201 Stainless Steel - 1/4" / 6.4mm wide



Preformed Stainless Steel Twice-Around clamps are the strongest clamps available for firesleeve or hose assembly. Use our Firesleeve Clamp Tool for closing and locking these clamps. Clamp widths available are 0.25", 0.375", 0.5", 0.625" and 0.75" wide. 0.25" wide clamps are type 201 stainless steel.

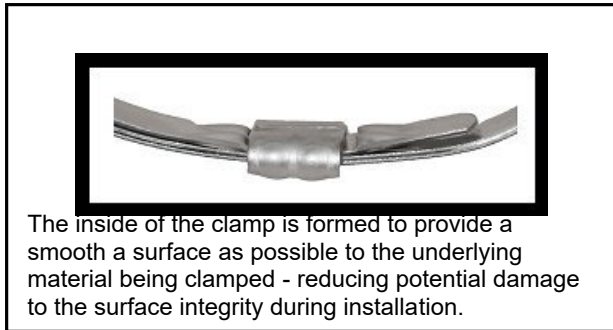
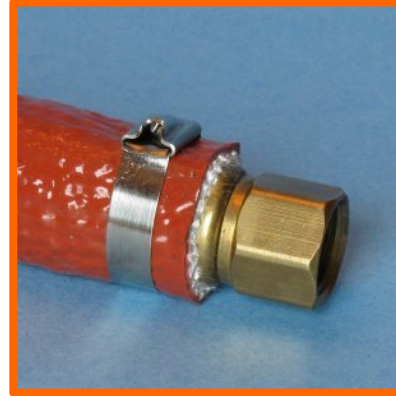

The inside of the clamp is formed to provide a smooth a surface as possible to the underlying material being clamped - reducing potential damage to the surface integrity during installation.

Free-end or twice-around clamps are used to secure firesleeve over hoses at the fitting. Twice-around clamps offer better tensile strength than free end clamps and provide superior clamping of hydraulic hoses onto fittings.

FlameShield™ Type 201 Stainless Steel Preformed Twice Around Clamps 1/4" / 0.25" / 6.35mm wide - .020"/.51mm thick		
Part Number	Max Sleeve or Hose OD Inches / mm	Price Each
C-TA-250-13-201SS	13/16 / 20	\$ 2.84
C-TA-250-16-201SS	1 / 25	\$ 2.96
C-TA-250-22-201SS	1 3/8 / 34	\$ 3.12
C-TA-250-24-201SS	1 1/2 / 38	\$ 3.27
C-TA-250-32-201SS	2 / 51	\$ 3.48
C-TA-250-40-201SS	2 1/2 / 63	\$ 3.84
C-TA-250-44-201SS	2 3/4 / 70	\$ 4.01
C-TA-250-48-201SS	3 / 76	\$ 4.08
C-TA-250-56-201SS	3 1/2 / 88	\$ 4.40
C-TA-250-64-201SS	4 / 101	\$ 5.32
C-TA-250-72-201SS	4 1/2 / 114	\$ 6.28

Full box quantity is 100 clamps. Discount for full box purchase is 35%
Half-box quantity is 50 clamps. Discount for half-box purchase is 25%

FlameShield™ Type 201 / 316 Stainless Steel / Galvanized Carbon Steel Preformed Twice Around Clamps 3/8" / 0.375" / 9.6mm wide - .025"/.64mm thick		
Part Number	Max Sleeve or Hose OD Inches / mm	Price Each 201 / 316 / Galv
C-TA-375-13-X	13/16 / 20	\$ 2.46 / \$ 6.93 / \$ 0.93
C-TA-375-16-X	1 / 25	\$ 2.83 / N/A / \$ 1.00
C-TA-375-22-X	1 3/8 / 34	\$ 2.76 / \$ 7.60 / \$ 1.03
C-TA-375-32-X	2 / 51	\$ 3.13 / \$ 9.00 / \$ 1.30
C-TA-375-40-X	2 1/2 / 63	\$ 3.56 / \$ 10.26 / \$ 1.90
C-TA-375-48-X	3 / 76	\$ 4.00 / N/A / \$ 1.67
C-TA-375-56-X	3 1/2 / 88	\$ 4.93 / \$ 12.60 / \$ 2.40
C-TA-375-64-X	4 / 101	\$ 4.73 / \$ 14.03 / \$ 2.63

For the "X" value, substitute:

- "201SS" for 201 Stainless Steel
- "316SS" for 316 Stainless Steel
- "GAL" for Galvanized Carbon Steel

Full box quantity is 100 clamps. Discount for full box purchase is 35%
 Half-box quantity is 50 clamps. Discount for half-box purchase is 25%

FlameShield™ Type 201 / 316 Stainless Steel / Galvanized Carbon Steel Preformed Twice Around Clamps 1/2" / 0.5" / 12.7mm wide - .030"/.76mm thick		
Part Number	Max Sleeve or Hose OD Inches / mm	Price Each 201 / 316 / Galv
C-TA-500-16-X	1 / 25	\$ 3.43 / \$ 10.47 / \$ 1.33
C-TA-500-20-X	1 1/4 / 31	\$ 3.77 / \$ 11.43 / \$ 1.47
C-TA-500-24-X	1 1/2 / 38	\$ 4.33 / N/A / \$ 1.63
C-TA-500-28-X	1 3/4 / 44	\$ 4.93 / N/A / \$ 1.93
C-TA-500-32-X	2 / 51	\$ 5.16 / \$ 15.80 / \$ 2.00
C-TA-500-40-X	2 1/2 / 63	\$ 5.43 / \$ 16.87 / \$ 2.10
C-TA-500-44-X	2 3/4 / 69	\$ 5.70 / N/A / \$ 2.30
C-TA-500-48-X	3 / 76	\$ 6.30 / \$ 19.23 / \$ 2.53
C-TA-500-56-X	3 1/2 / 88	\$ 6.90 / \$ 21.20 / \$ 2.87
C-TA-500-64-X	4 / 101	\$ 7.53 / \$ 23.00 / \$ 3.23

For the "X" value, substitute:

- "201" for 201 Stainless Steel
- "316" for 316 Stainless Steel
- "GAL" for Galvanized Carbon Steel

Full box quantity is 100 clamps. Discount for full box purchase is 35%
 Half-box quantity is 50 clamps. Discount for half-box purchase is 25%

FlameShield™ Type 201 / 316 Stainless Steel / Galvanized Carbon Steel Preformed Twice Around Clamps 5/8" / 0.625" / 15.9mm wide - .030"/.76mm thick		
Part Number	Max Sleeve or Hose OD Inches / mm	Price Each 201 / 316 / Galv
C-TA-625-24-X	1 1/2 / 38	\$ 5.44 / \$ 16.56 / \$ 2.04
C-TA-625-28-X	1 3/4 / 38	\$ 6.04 / \$ 18.60 / \$ 2.28
C-TA-625-32-X	2 / 51	\$ 6.60 / \$ 20.40 / \$ 2.48
C-TA-625-36-X	2 1/4 / 57	\$ 7.04 / \$ 21.76 / \$ 2.64
C-TA-625-40-X	2 1/2 / 63	\$ 7.48 / \$ CALL / \$ 2.88

For the "X" value, substitute:

- "201" for 201 Stainless Steel
- "316" for 316 Stainless Steel
- "GAL" for Galvanized Carbon Steel

Full box quantity is 100 clamps. Discount for full box purchase is 35%
 Half-box quantity is 50 clamps. Discount for half-box purchase is 25%

FlameShield™ Type 201 / 316 Stainless Steel / Galvanized Carbon Steel Preformed Twice Around Clamps 3/4" / 0.75" / 19.1mm wide - .030"/.76mm thick		
Part Number	Max Sleeve or Hose OD Inches / mm	Price Each 201 / 316 / Galv
C-TA-750-32-X	2 / 51	\$ 8.16 / \$ 25.60 / \$ 3.04
C-TA-750-44-X	2 3/4 / 69	\$ 8.88 / \$ 29.64 / \$ 3.44
C-TA-750-48-X	3 / 76	\$ 9.64 / \$ 30.96 / \$ 3.60
C-TA-750-56-X	3 1/2 / 88	\$ 10.24 / \$ 33.68 / \$ 3.92
C-TA-750-64-X	4 / 101	\$ 11.76 / \$ 36.32 / \$ 4.52
C-TA-750-72-X	4 1/2 / 114	\$ 12.64 / \$ 39.00 / \$ 4.76
C-TA-750-80-X	5 / 127	\$ 13.64 / \$ 41.68 / \$ 5.90
C-TA-750-84-X	5 1/4 / 133	\$ 14.16 / \$ 43.56 / \$ 6.10
C-TA-750-96-X	6 / 152	\$ 15.68 / \$ 48.16 / \$ 6.40
C-TA-750-100-X	6 1/4 / 165	\$ 17.28 / \$ N/A / \$ 6.56
C-TA-750-112-X	7 / 177	\$ CALL / \$ N/A / \$ 7.12
C-TA-750-128-X	8 / 203	\$ 21.28 / \$ N/A / \$ 10.08

For the "X" value, substitute:

- "201" for 201 Stainless Steel
- "316" for 316 Stainless Steel
- "GAL" for Galvanized Carbon Steel

Full box quantity is 100 clamps. Discount for full box purchase is 35%
 Half-box quantity is 50 clamps. Discount for half-box purchase is 25%



Firesleeve Stainless Steel Clamps Free End Clamps & Clamp Tool



Clamps – Stainless Steel; Free End; Self Locking

These stainless steel clamps are self locking and can be closed with common hand tools such as standard or needle nose pliers. A tighter clamping can be achieved with the Firesleeve Clamp Tools.

Clamps are available in two widths: .181" (tensile 96 lbs) and .311" (tensile 242 lbs). Clamps longer than 20" are available – call for details. Available in 304 and 316 Stainless Steel.

Free End Clamps – .18" / 5mm wide - 304/316 Stainless Steel – Self Locking					
Part Number	Max Sleeve ID Inches / mm	Clamp width inches / mm	Length inch / mm	Price 100 Bag 304 / 316	Price Each 304 / 316
C-SSSL-3XX-W181-L06-X	7/16 / 11	0.181 / 5.0	6" / 152	\$ 121.00 / \$ 139.00	\$ 1.82 / \$ 2.09
C-SSSL-3XX-W181-L08-X	1 1/8 / 28	0.181 / 5.0	8" / 203	\$ 139.00 / \$ 160.00	\$ 2.09 / \$ 2.40
C-SSSL-3XX-W181-L14-X	3 / 76	0.181 / 5.0	14" / 355	\$ 159.00 / \$ 183.00	\$ 2.39 / \$ 2.75
C-SSSL-3XX-W181-L20-X	5 / 127	0.181 / 5.0	20" / 508	\$ 211.00 / \$ 243.00	\$ 3.17 / \$ 3.65

Free End Clamps – .31" / 8mm wide - 304/316 Stainless Steel – Self Locking					
Part Number	Max Sleeve ID Inches / mm	Clamp width inches / mm	Length inch / mm	Price 100 Bag 304 / 316	Price Each 304 / 316
C-SSSL-3XX-W311-L08-X	1 1/8 / 28	0.311 / 8.0	8" / 203	\$ 159.00 / \$ 183.00	\$ 2.39 / \$ 2.75
C-SSSL-3XX-W311-L14-X	3 / 76	0.311 / 8.0	14" / 355	\$ 229.00 / \$ 263.00	\$ 3.44 / \$ 3.95
C-SSSL-3XX-W311-L20-X	5 / 127	0.311 / 8.0	20" / 508	\$ 387.00 / \$ 445.00	\$ 5.80 / \$ 6.68
C-SSSL-PPAP	Level 1 PAPP Certificate – (Per Line Item)			\$ 460.00	

Clamp Tool		
C-FCT-1		\$ 44.61

For the "X" value:
substitute "04" for 304 Stainless Steel or "16" for 316 Stainless Steel



Firesleeve Stainless Steel Clamps Free End Clamps & Clamp Tool



Firesleeve Clamp Tool

Firesleeve Clamp Tool aids in the tightening of either style of clamp up to 3/8" wide. Built-in handles for the winder and cutter or a standard 1/2" wrench can be used for additional torque on the winder. The tool requires 4.5" of clamp free end for the winder to be properly loaded.

Clamp Tool		
C-FCT-1		\$ 44.61



Using FlameShield™ end wrap compression tape over the clamp makes for a neat and clean installation that prevents contamination of the sleeve end.

Firesleeve Stainless Steel Preformed Twice Around Clamps – Smooth ID

Dimensional Data

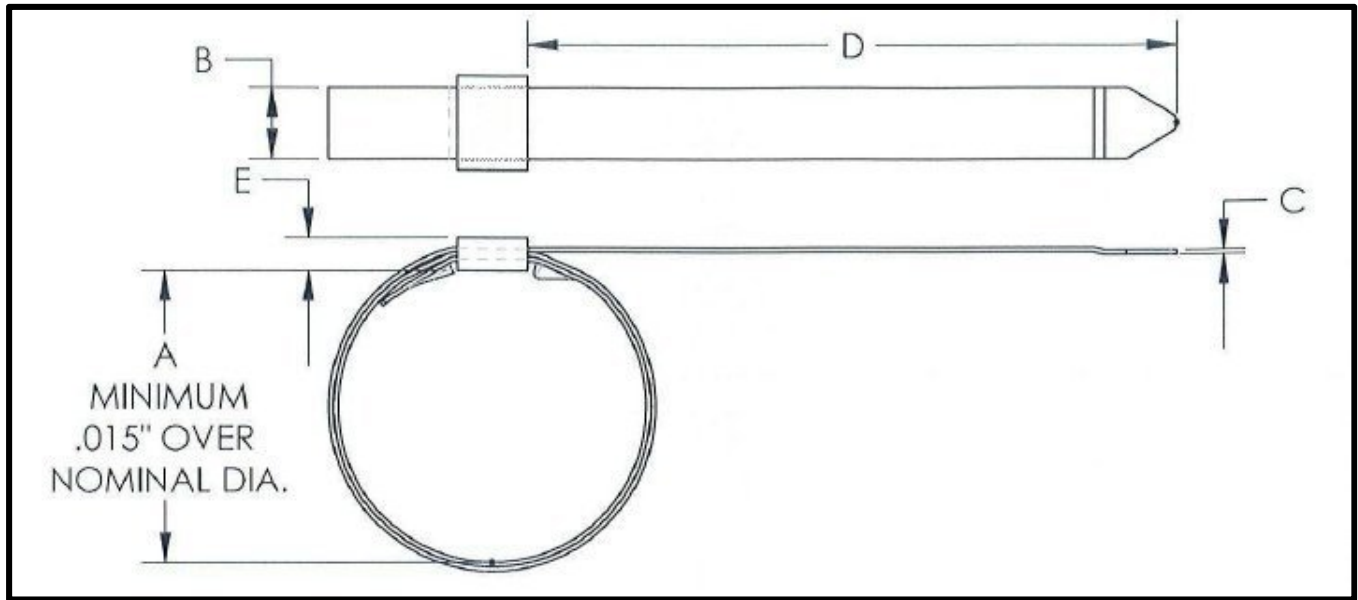

Twice Around Clamp Physical Dimensions and Material Specifications

Part Number	Material Band / Buckle	Nominal I.D.	Width +/- .005	Thickne ss +/- .002	Tail Length	Buckle Height Max
-------------	------------------------	--------------	----------------	---------------------	-------------	-------------------

InsulDynamic™ Firesleeve with VELCRO® Brand Hook & Loop Closure
500°F / 260°C Continuous Rating – Higher Temperature for Shorter Periods
High Temperature, Heat, Flame, Fire, Weld Splatter and Molten Splash & Slag Resistant



InsulDynamic™ Firesleeve with flame retardant hook and loop or VELCRO® Brand closure is a high temperature heavy duty sleeve for protecting industrial hose and cable, but with the benefits of being installed & removed as required without disconnecting the hose, cable or wire.

The sleeve is fabricated from a braided base fabric (similar to our S-FSHD sleeve construction) which provides radial elasticity, easily accommodating connectors and splices.

Typical applications include:

- Electric Arc Furnace cable covers
- Robotic welding cable protection
- Steel mill roll-stand hydraulic hose protection
- Steel mill cooling water hose protection
- Vehicle under-hood wire, cable and hose protection or as a cover in extreme environments where serviceability is required.

The closure remains inside of the sleeve and is protected by the fabric overlap. The thread used is a high temperature e-fiberglass for installation with no or minimal flexing. A Nomex thread is used for installations subject to flexing.

Flame retardant hook & loop is utilized meeting MIL-F-21840, AA-55126, NFPA 1971-1991, FMVSS 302, FAA 25.853a. VELCRO® Brand hook and loop is also available.

This product may be suitable to protect personnel from hot pipe burns and OSHA compliance. Please contact our technical support in order to calculate temperature drop profile in your application.

Also an excellent cold temperature sleeve with flexibility to -76°C for refrigeration and cryogenic applications.

This is a custom fabrication item – please allow 3 to 10 business days from date of order. Contact us to determine the specific production time for your order.

The long edge of the sleeve has some fray of the underlying fiberglass, which does not affect the performance of the sleeve, and is only an aesthetic consideration.

The standard hook and loop and also VELCRO® Brand closure is a nylon material. Nomex® and Stainless Steel is available. For Nomex® add \$7.00 per foot to listed price. For Stainless Steel add \$36.00 per foot to listed price. Sleeve with Nomex® or Stainless Steel closure will have 1" wide closure material. Delivery time for other than standard will be a few additional days. See our catalog page for Nomex® and Stainless Steel closure for temperature ratings and other specifications.

Sizes larger than 5 inches ID contain an overlap seam of the base material opposite the closure location.

InsulDynamic™ Firesleeve with VELCRO® Brand Hook & Loop Closure

500°F / 260°C Continuous Rating – Higher Temperature for Shorter Periods

High Temperature, Heat, Flame, Fire, Weld Splatter and Molten Slag Resistant



**500°F / 260°C continuous rating with weld splatter / molten metal splash protection.
2200°F / 1205°C for periods up to 15 minutes and short excursions to 3000°F / 1650°C.**

InsulDynamic™ Firesleeve with VELCRO® Brand Hook / Loop Closure - Small Diameter						
Nominal ID inches / mm / Dash #			Part Number	Hook & loop Width, inches	Price per Foot	Price per Metre
1/2	13	-08	S-FS-VCL-SM-M013-08	1/2	\$ 14.56	\$ 47.76
3/4	19	-12	S-FS-VCL-SM-M019-12	1/2	\$ 17.34	\$ 56.88
1	25	-16	S-FS-VCL-SM-M025-16	5/8	\$ 20.29	\$ 66.55
1 1/4	32	-20	S-FS-VCL-SM-M032-20	5/8	\$ 22.60	\$ 74.13
1 1/2	38	-24	S-FS-VCL-SM-M038-24	3/4	\$ 24.83	\$ 81.44
1 3/4	44	-28	S-FS-VCL-SM-M044-28	3/4	\$ 26.77	\$ 87.81
2	51	-32	S-FS-VCL-SM-M051-32	3/4	\$ 29.21	\$ 95.81
2 1/4	57	-36	S-FS-VCL-SM-M057-36	3/4	\$ 31.23	\$ 102.43
2 1/2	64	-40	S-FS-VCL-SM-M064-40	3/4	\$ 33.49	\$ 109.85
2 3/4	70	-44	S-FS-VCL-SM-M070-44	3/4	\$ 35.80	\$ 117.42
3	76	-48	S-FS-VCL-SM-M076-48	1	\$ 37.94	\$ 124.44
3 1/4	83	-52	S-FS-VCL-SM-M083-52	1	\$ 40.34	\$ 132.32
3 1/2	89	-56	S-FS-VCL-SM-M089-56	1	\$ 42.29	\$ 138.71
3 3/4	95	-60	S-FS-VCL-SM-M095-60	1	\$ 44.51	\$ 145.99
4	102	-64	S-FS-VCL-SM-M102-64	1	\$ 48.37	\$ 158.65
4 1/4	108	-68	S-FS-VCL-SM-M108-68	1	\$ 50.54	\$ 165.77
4 1/2	114	-72	S-FS-VCL-SM-M114-72	1	\$ 52.94	\$ 173.64
4 3/4	121	-76	S-FS-VCL-SM-M121-76	1	\$ 55.17	\$ 180.96
5	127	-80	S-FS-VCL-SM-M127-80	1	\$ 57.54	\$ 188.73

Available in continuous lengths up to 100 feet for up to 3.5" I.D.

Customer may specify a hook/loop width other than standard if desired (except for 1/2 and 3/4" sleeve).

Continued....

InsulDynamic™ Firesleeve with VELCRO® Brand Hook & Loop Closure (Continued) Large Diameter

Large Diameter Firesleeve with VELCRO® Brand Hook & Loop Closure in sizes larger than 5 inches ID contains an overlap seam of the material opposite the closure location.

500°F / 260°C continuous rating with weld splatter / molten metal splash protection.
2200°F / 1205°C for periods up to 15 minutes and short excursions to 3000°F / 1650°C.

InsulDynamic™ Firesleeve with VELCRO® Brand Hook & Loop Closure: Large Diameter						
Nominal ID inches / mm / Dash #			Part Number	Hook/Loop Width, inches	Price per Foot	Price per Metre
5 1/4	133	-84	S-FS-VCL-LG-M133-84	2	\$ 59.37	\$ 194.73
5 1/2	140	-88	S-FS-VCL-LG-M140-88	2	\$ 61.66	\$ 202.25
5 3/4	146	-92	S-FS-VCL-LG-M146-92	2	\$ 63.94	\$ 209.72
6	152	-96	S-FS-VCL-LG-M152-96	2	\$ 66.11	\$ 216.84
6 1/4	159	-100	S-FS-VCL-LG-M159-100	2	\$ 68.51	\$ 224.71
6 1/2	165	-104	S-FS-VCL-LG-M165-104	2	\$ 70.74	\$ 232.03
6 3/4	171	-108	S-FS-VCL-LG-M171-108	2	\$ 72.74	\$ 238.59
7	178	-112	S-FS-VCL-LG-M178-112	2	\$ 74.97	\$ 245.90
7 1/4	184	-116	S-FS-VCL-LG-M184-116	2	\$ 76.97	\$ 252.46
7 1/2	191	-120	S-FS-VCL-LG-M191-120	2	\$ 79.54	\$ 260.89
7 3/4	197	-124	S-FS-VCL-LG-M197-124	2	\$ 81.77	\$ 268.21
8	203	-128	S-FS-VCL-LG-M203-128	2	\$ 83.69	\$ 274.50
8 1/4	210	-132	S-FS-VCL-LG-M210-132	2	\$ 86.26	\$ 282.93
8 1/2	216	-136	S-FS-VCL-LG-M216-136	2	\$ 88.43	\$ 290.05
8 3/4	222	-140	S-FS-VCL-LG-M222-140	2	\$ 90.23	\$ 295.95
9	229	-144	S-FS-VCL-LG-M229-144	2	\$ 92.57	\$ 303.63
9 1/4	235	-148	S-FS-VCL-LG-M235-148	2	\$ 94.49	\$ 309.93
9 1/2	241	-152	S-FS-VCL-LG-M241-152	2	\$ 97.20	\$ 318.82
9 3/4	248	-156	S-FS-VCL-LG-M248-156	2	\$ 99.37	\$ 325.93
10	254	-160	S-FS-VCL-LG-M254-160	2	\$ 101.66	\$ 333.45
10 1/4	260	-164	S-FS-VCL-LG-M260-164	2	\$ 104.00	\$ 341.12
10 1/2	267	-168	S-FS-VCL-LG-M267-168	2	\$ 105.60	\$ 346.37
10 3/4	273	-172	S-FS-VCL-LG-M273-172	2	\$ 113.31	\$ 371.66
11	279	-176	S-FS-VCL-LG-M279-176	2	\$ 115.66	\$ 379.36
11 1/4	286	-180	S-FS-VCL-LG-M286-180	2	\$ 118.51	\$ 388.71
11 1/2	292	-184	S-FS-VCL-LG-M292-184	2	\$ 122.37	\$ 401.37
11 3/4	298	-188	S-FS-VCL-LG-M298-188	2	\$ 126.22	\$ 414.01
12	305	-192	S-FS-VCL-LG-M305-192	1.5	\$ 129.41	\$ 424.46

Available in continuous lengths up to 100 feet. Larger Diameters available by quote.

The standard closure is nylon. Nomex® and Stainless Steel is available. For Nomex® add \$7.00 per foot to listed price and for Stainless Steel add \$36.00 per foot to listed price for 1" wide closure. For Nomex® add \$14.00 per foot to listed price and for Stainless Steel add \$72.00 per foot to listed price for 2" wide closure (2" wide is constructed by using 2 x 1" wide). Delivery time for other than standard will be a few additional days. See our catalog page for Nomex® and Stainless Steel closure for temperature ratings and other specifications.



SplashGard™ HD Sleeve with VELCRO® Brand Hook & Loop Closure 500°F / 260°C Continuous Rating – Higher Temperature for Shorter Periods High Temperature, Heat, Flame, Fire, Weld Splatter and Molten Splash & Slag Resistant



SplashGard™ HD sleeve is a high temperature sleeve with a flame retardant hook and loop or VELCRO® Brand hook and loop closure that is suitable to protect hoses and cables from molten splash.

It may be installed and removed without disconnecting the hose, cable or wire. The sleeve is fabricated from a heavy duty woven fabric which is then coated with a thick layer of self extinguishing silicone rubber elastomer.

Due to the woven base material and deep elastomer impregnation, this material is stiff and provides no elasticity compared to our standard duty version. This sleeve should be slightly oversized if it will require flexing or installation on curved installations. It is designed for straight or slightly curved sections or runs of hose, pipe or cables, and is difficult to use in a curved path.

Typical applications include protection of Electric Arc Furnace cables, robotic welding cables, steel mill roll-stand hydraulic hoses, steel mill cooling water hoses, vehicle under-hood wiring, cable and hoses. The same material is also used to fabricate custom protection covers for enclosures and equipment protection where serviceability is required.

The closure remains inside of the sleeve and is protected by the fabric overlap. Thread used is a high temperature e-fiberglass. Flame retardant hook & loop is utilized meeting MIL-F-21840, AA-55126, NFPA 1971-1991, FMVSS 302, FAA 25.853a.

This product may be suitable to protect personnel from hot pipe burns and OSHA compliance. Please contact our technical support in order to calculate temperature drop profile in your application.

Also an excellent cold temperature sleeve with flexibility to -76°C for refrigeration and cryogenic applications.

This is a custom fabrication item – please allow 3 to 10 business days from date of order. Contact us to determine the specific production time for your order.

The long edge of the sleeve has some fray of the underlying fiberglass, which does not affect the performance of the sleeve, and is only an aesthetic consideration.

The standard closure is nylon. Nomex® and Stainless Steel is available. For Nomex® add \$7.00 per foot to listed price. For Stainless Steel add \$36.00 per foot to listed price. Sleeve with Nomex® or Stainless Steel closure will have 1" wide closure material. Delivery time for other than standard will be a few additional days. See our catalog page for Nomex® and Stainless Steel closure for temperature ratings and other specifications.

SplashGard™ HD Sleeve with VELCRO® Brand Hook & Loop Closure

500°F / 260°C Continuous Rating – Higher Temperature for Shorter Periods

High Temperature, Heat, Flame, Fire, Weld Splatter and Molten Slag Resistant

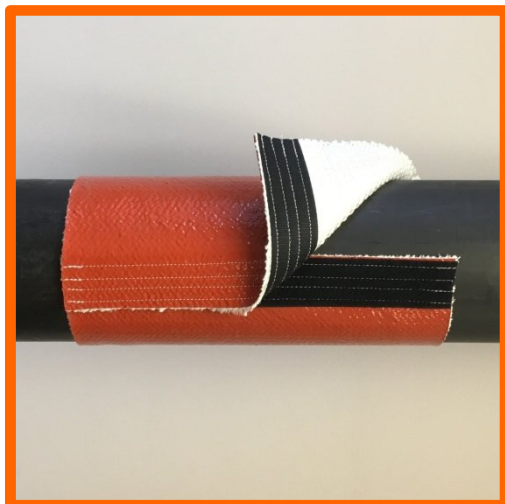

500°F / 260°C continuous rating with weld splatter / molten metal splash protection.
2200°F / 1205°C for periods up to 15 minutes and short excursions to 3000°F / 1650°C.

**SplashGard™ HD Sleeve with VELCRO® Brand Hook / Loop Closure
Small Diameter**

Nominal ID inches / mm / Dash #			Part Number	Hook & loop Width, inches	Price per Foot	Price per Metre
1 1/2	38	-24	S-FGSRHD-VCL-M038-24	3/4	\$ 24.83	\$ 81.44
1 3/4	44	-28	S-FGSRHD-VCL-M044-28	3/4	\$ 26.77	\$ 87.81
2	51	-32	S-FGSRHD-VCL-M051-32	3/4	\$ 29.21	\$ 95.81
2 1/4	57	-36	S-FGSRHD-VCL-M057-36	3/4	\$ 31.23	\$ 102.43
2 1/2	64	-40	S-FGSRHD-VCL-M064-40	3/4	\$ 33.49	\$ 109.85
2 3/4	70	-44	S-FGSRHD-VCL-M070-44	3/4	\$ 35.80	\$ 117.42
3	76	-48	S-FGSRHD-VCL-M076-48	1	\$ 37.94	\$ 124.44
3 1/4	83	-52	S-FGSRHD-VCL-M083-52	1	\$ 40.34	\$ 132.32
3 1/2	89	-56	S-FGSRHD-VCL-M089-56	1	\$ 42.29	\$ 138.71
3 3/4	95	-60	S-FGSRHD-VCL-M095-60	1	\$ 44.51	\$ 145.99
4	102	-64	S-FGSRHD-VCL-M102-64	1	\$ 48.37	\$ 158.65
4 1/4	108	-68	S-FGSRHD-VCL-M108-68	1	\$ 50.54	\$ 165.77
4 1/2	114	-72	S-FGSRHD-VCL-M114-72	1	\$ 52.94	\$ 173.64
4 3/4	121	-76	S-FGSRHD-VCL-M121-76	1	\$ 55.17	\$ 180.96
5	127	-80	S-FGSRHD-VCL-M127-80	1	\$ 57.54	\$ 188.73

Available in continuous lengths up to 100 feet for up to 3.5" I.D.

Customer may specify a hook/loop width other than standard if desired (except for 1/2 and 3/4" sleeve).

Continued...

SplashGard™ HD Sleeve with VELCRO® Brand Hook & Loop Closure (Continued)
Large Diameter

Large Diameter Firesleeve with VELCRO® Brand Hook & Loop Closure in sizes larger than 5 inches ID contains an overlap seam of the material opposite the closure.

500°F / 260°C continuous rating with weld splatter / molten metal splash protection.
 2200°F / 1205°C for periods up to 15 minutes and short excursions to 3000°F / 1650°C.

SplashGard™ HD Sleeve with VELCRO® Brand Hook & Loop Closure: Large Diameter						
Nominal ID inches / mm / Dash #			Part Number	Hook/Loop Width, inches	Price per Foot	Price per Metre
5 1/4	133	-84	S-FGSRHD-VCL-M133-84	2	\$ 59.37	\$ 194.73
5 1/2	140	-88	S-FGSRHD-VCL-M140-88	2	\$ 61.66	\$ 202.25
5 3/4	146	-92	S-FGSRHD-VCL-M146-92	2	\$ 63.94	\$ 209.72
6	152	-96	S-FGSRHD-VCL-M152-96	2	\$ 66.11	\$ 216.84
6 1/4	159	-100	S-FGSRHD-VCL-M159-100	2	\$ 68.51	\$ 224.71
6 1/2	165	-104	S-FGSRHD-VCL-M165-104	2	\$ 70.74	\$ 232.03
6 3/4	171	-108	S-FGSRHD-VCL-M171-108	2	\$ 72.74	\$ 238.59
7	178	-112	S-FGSRHD-VCL-M178-112	2	\$ 74.97	\$ 245.90
7 1/4	184	-116	S-FGSRHD-VCL-M184-116	2	\$ 76.97	\$ 252.46
7 1/2	191	-120	S-FGSRHD-VCL-M191-120	2	\$ 79.54	\$ 260.89
7 3/4	197	-124	S-FGSRHD-VCL-M197-124	2	\$ 81.77	\$ 268.21
8	203	-128	S-FGSRHD-VCL-M203-128	2	\$ 83.69	\$ 274.50
8 1/4	210	-132	S-FGSRHD-VCL-M210-132	2	\$ 86.26	\$ 282.93
8 1/2	216	-136	S-FGSRHD-VCL-M216-136	2	\$ 88.43	\$ 290.05
8 3/4	222	-140	S-FGSRHD-VCL-M222-140	2	\$ 90.23	\$ 295.95
9	229	-144	S-FGSRHD-VCL-M229-144	2	\$ 92.57	\$ 303.63
9 1/4	235	-148	S-FGSRHD-VCL-M235-148	2	\$ 94.49	\$ 309.93
9 1/2	241	-152	S-FGSRHD-VCL-M241-152	2	\$ 97.20	\$ 318.82
9 3/4	248	-156	S-FGSRHD-VCL-M248-156	2	\$ 99.37	\$ 325.93
10	254	-160	S-FGSRHD-VCL-M254-160	2	\$ 101.66	\$ 333.45
10 1/4	260	-164	S-FGSRHD-VCL-M260-164	2	\$ 104.00	\$ 341.12
10 1/2	267	-168	S-FGSRHD-VCL-M267-168	2	\$ 105.60	\$ 346.37
10 3/4	273	-172	S-FGSRHD-VCL-M273-172	2	\$ 113.31	\$ 371.66
11	279	-176	S-FGSRHD-VCL-M279-176	2	\$ 115.66	\$ 379.36
11 1/4	286	-180	S-FGSRHD-VCL-M286-180	2	\$ 118.51	\$ 388.71
11 1/2	292	-184	S-FGSRHD-VCL-M292-184	2	\$ 122.37	\$ 401.37
11 3/4	298	-188	S-FGSRHD-VCL-M298-188	2	\$ 126.22	\$ 414.01
12	305	-192	S-FGSRHD-VCL-M305-192	1.5	\$ 129.41	\$ 424.46

Available in continuous lengths up to 100 feet. Larger Diameters available by quote.

The standard closure is nylon. Nomex® and Stainless Steel is available. For Nomex® add \$7.00 per foot to listed price and for Stainless Steel add \$36.00 per foot to listed price for 1" wide closure. For Nomex® add \$14.00 per foot to listed price and for Stainless Steel add \$72.00 per foot to listed price for 2" wide closure (2" wide is constructed by using 2 x 1" wide). Delivery time for other than standard will be a few additional days. See our catalog page for Nomex® and Stainless Steel closure for temperature ratings and other specifications.

Aviation Firesleeve with FR Hook & Loop Closure

500°F / 260°C Continuous Rating – Higher Temperature for Shorter Periods
High Temperature, Heat, Flame & Fire Resistant

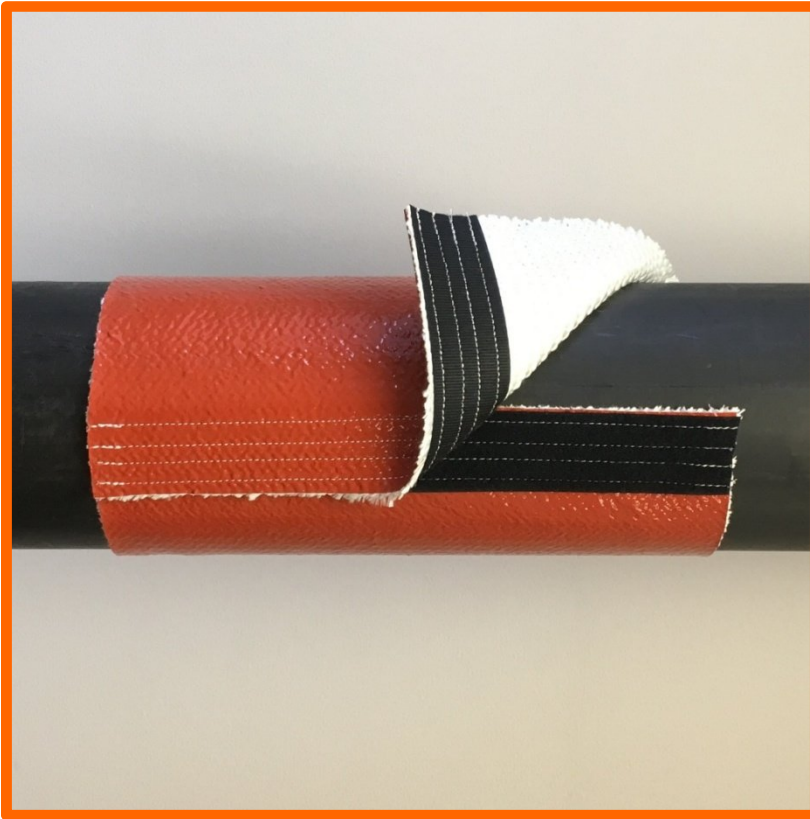

ZeusGard™ Firesleeve is a high temperature sleeve with YKK brand flame retardant hook and loop or VELCRO® Brand closure. SAE AS1072 firesleeve is used for construction of this retrofit sleeve which can be installed without disconnecting hoses, cables or wiring.

Typical applications are to protect fluid carrying hoses, cables and wires that are exposed to high temperatures or for additional protection in the event of fire. No guarantee is made as to the fire exposure time that this sleeve provides as it is modified from the AS1072 specification. Critical system components should be protected with standard AS1072 firesleeve without hook & loop closure.

The closure remains protected inside of the sleeve and is protected by the fabric overlap. The thread used is a high temperature e-fiberglass. Other threads such as stainless steel are available. The standard nylon hook and loop closure is flame retardant and meets MIL-F-21840, AA-55126, NFPA 1971-1991, FMVSS 302, FAA 25.853a.

To aid in keeping the firesleeve closed in the event of exposure to higher than rated temperatures or in the event of flame exposure, this sleeve should be further secured with metal band clamps spaced at regular intervals.

This is a custom fabrication item – please allow 2 to 5 business days from date of order. Contact us to determine the specific production time for your order.

The long edge of the sleeve has some fray of the underlying fiberglass, which does not affect the performance of the sleeve, and is only an aesthetic consideration.

The standard closure is nylon hook & loop. Nomex® and Stainless Steel is available. For Nomex® add \$7.00 per foot. For Stainless Steel add \$36.00 per foot. Sleeve with Nomex® or Stainless Steel closure will have 1" wide closure material. Delivery time for other than standard will be a few additional days. See our catalog page for Nomex® and Stainless Steel closures for temperature ratings and other specifications.

Aviation Firesleeve with FR Hook & Loop Closure (Continued)
500°F / 260°C Continuous Rating – Higher Temperature for Shorter Periods
High Temperature, Heat, Flame & Fire Resistant

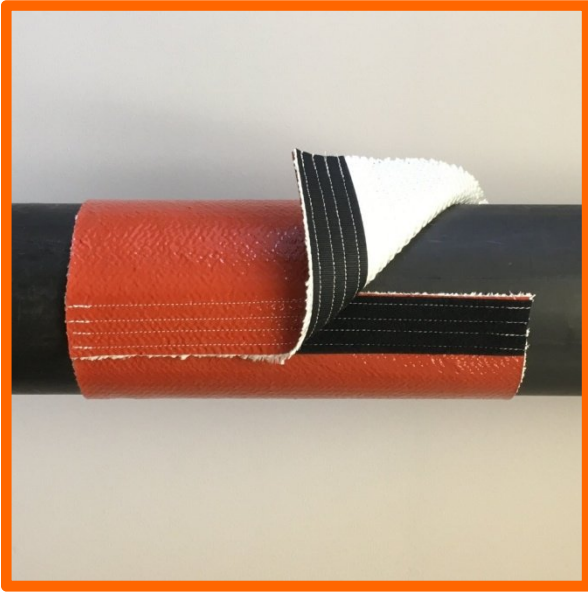

500°F / 260°C continuous rating.
2200°F / 1205°C for periods up to 15 minutes and short excursions to 3000°F / 1650°C.

ZeusGard™ Aviation Firesleeve with Hook & Loop Closure						
Nominal ID inches / mm / Dash #			Part Number	Hook & loop Width, inches	Price per Foot	Price per Metre
1/2	13	-08	S-FS-VCL-AERO-M013-08	1/2	\$ 17.56	\$ 57.60
3/4	19	-12	S-FS-VCL-AERO-M019-12	1/2	\$ 20.34	\$ 66.72
1	25	-16	S-FS-VCL-AERO-M025-16	5/8	\$ 23.29	\$ 76.39
1 1/4	32	-20	S-FS-VCL-AERO-M032-20	5/8	\$ 25.60	\$ 83.97
1 1/2	38	-24	S-FS-VCL-AERO-M038-24	3/4	\$ 27.83	\$ 91.28
1 3/4	44	-28	S-FS-VCL-AERO-M044-28	3/4	\$ 29.77	\$ 97.65
2	51	-32	S-FS-VCL-AERO-M051-32	3/4	\$ 32.21	\$ 105.65
2 1/4	57	-36	S-FS-VCL-AERO-M057-36	3/4	\$ 34.23	\$ 112.27
2 1/2	64	-40	S-FS-VCL-AERO-M064-40	3/4	\$ 37.49	\$ 122.97
2 3/4	70	-44	S-FS-VCL-AERO-M070-44	3/4	\$ 38.80	\$ 127.26
3	76	-48	S-FS-VCL-AERO-M076-48	1	\$ 40.94	\$ 134.28
3 1/4	83	-52	S-FS-VCL-AERO-M083-52	1	\$ 43.34	\$ 142.16
3 1/2	89	-56	S-FS-VCL-AERO-M089-56	1	\$ 45.29	\$ 148.55
3 3/4	95	-60	S-FS-VCL-AERO-M095-60	1	\$ 47.21	\$ 154.85
4	102	-64	S-FS-VCL-AERO-M102-64	1	\$ 48.37	\$ 158.65
4 1/4	108	-68	S-FS-VCL-AERO-M108-68	1	\$ 50.54	\$ 165.77
4 1/2	114	-72	S-FS-VCL-AERO-M114-72	1	\$ 52.94	\$ 173.64
4 3/4	121	-76	S-FS-VCL-AERO-M121-76	1	\$ 55.17	\$ 180.96
5	127	-80	S-FS-VCL-AERO-M127-80	1	\$ 57.54	\$ 188.73

Available in continuous lengths up to 100 feet.
Larger ID (Inside Diameter) Sizes Available - Please Ask



Firesleeve with Metal Snap Closure

500°F / 260°C Continuous Rating – Higher Temperature for Shorter Periods

High Temperature, Heat, Flame & Fire Resistant

Removable silicone rubber coated fiberglass sleeve with snap closure provides heavy duty weld splatter & molten splash protection



SnapSleeve™ Firesleeve is a heavy duty silicone rubber coated fibreglass sleeve with snap style closures protects industrial wire, cable and hose with the benefits of being installed & removed as required. Typical applications are as robotic welding cable protection, steel mill roll-stand hydraulic hose protection or as a cover in extreme environments where serviceability is required. This is a custom fabrication item – please allow 3 to 10 business days from date of order. Available in continuous lengths up to 100 feet for IDs up to 3 1/2” and 75 feet for IDs larger than 3 3/4”. Standard snap spacing is 3” but can be adjusted to the customer’s preference.

Also an excellent cold temperature sleeve with flexibility to -76°C for refrigeration and cryogenic applications.

**500°F / 260°C continuous rating with weld splatter / molten metal splash protection.
2200°F / 1205°C for periods up to 15 minutes and short excursions to 3000°F / 1650°C.**

SnapSleeve™ Firesleeve with Metal Snap Closure					
Heavy Duty Removable Molten Splash Protection Sleeve					
Nominal ID inches / mm / Dash #			Part Number	Price Per Foot	Price Per Metre
1	25	-16	S-FS-SNAP-M025-16	\$ 20.29	\$ 66.55
1 1/4	32	-20	S-FS-SNAP-M032-20	\$ 22.60	\$ 74.13
1 1/2	38	-24	S-FS-SNAP-M038-24	\$ 24.83	\$ 81.44
1 3/4	44	-28	S-FS-SNAP-M044-28	\$ 26.77	\$ 87.81
2	51	-32	S-FS-SNAP-M051-32	\$ 29.00	\$ 95.12
2 1/4	57	-36	S-FS-SNAP-M057-36	\$ 31.23	\$ 102.43
2 1/2	64	-40	S-FS-SNAP-M064-40	\$ 33.49	\$ 109.85
2 3/4	70	-44	S-FS-SNAP-M070-44	\$ 35.80	\$ 117.42
3	76	-48	S-FS-SNAP-M076-48	\$ 37.94	\$ 124.44
3 1/4	83	-52	S-FS-SNAP-M083-52	\$ 40.34	\$ 132.32
3 1/2	89	-56	S-FS-SNAP-M089-56	\$ 42.29	\$ 138.71

This Product is Available By-The-Foot / Metre. Larger IDs Available

Firesleeve with Metal Snap Closure (Continued)

Large Diameter



SnapSleeve™ Firesleeve with Metal Snap Closure					
Heavy Duty Removable Molten Splash Protection Sleeve					
Nominal ID inches / mm / Dash #			Part Number	Price Per Foot	Price Per Metre
3 3/4	95	-60	S-FS-SNAP-M095-60	\$ 44.51	\$ 145.99
4	102	-64	S-FS-SNAP-M102-64	\$ 48.37	\$ 158.65
4 1/4	108	-68	S-FS-SNAP-M108-68	\$ 50.54	\$ 165.77
4 1/2	114	-72	S-FS-SNAP-M114-72	\$ 52.94	\$ 173.64
4 3/4	121	-76	S-FS-SNAP-M121-76	\$ 55.17	\$ 180.96
5	127	-80	S-FS-SNAP-M127-80	\$ 57.54	\$ 188.73
5 1/4	133	-84	S-FS-SNAP-M133-84	\$ 59.37	\$ 194.73
5 1/2	140	-88	S-FS-SNAP-M140-88	\$ 61.66	\$ 202.25
5 3/4	146	-92	S-FS-SNAP-M146-92	\$ 63.94	\$ 209.72
6	152	-96	S-FS-SNAP-M152-96	\$ 66.11	\$ 216.84
6 1/4	159	-100	S-FS-SNAP-M159-100	\$ 68.51	\$ 224.71
6 1/2	165	-104	S-FS-SNAP-M165-104	\$ 70.74	\$ 232.03
6 3/4	171	-108	S-FS-SNAP-M171-108	\$ 72.74	\$ 238.59
7	178	-112	S-FS-SNAP-M178-112	\$ 74.97	\$ 245.90
7 1/4	184	-116	S-FS-SNAP-M184-116	\$ 76.97	\$ 252.46
7 1/2	191	-120	S-FS-SNAP-M191-120	\$ 79.54	\$ 260.89
7 3/4	197	-124	S-FS-SNAP-M197-124	\$ 81.77	\$ 268.21
8	203	-128	S-FS-SNAP-M203-128	\$ 83.69	\$ 274.50
8 1/4	210	-132	S-FS-SNAP-M210-132	\$ 86.26	\$ 282.93
8 1/2	216	-136	S-FS-SNAP-M216-136	\$ 88.43	\$ 290.05
8 3/4	222	-140	S-FS-SNAP-M222-140	\$ 90.23	\$ 295.95
9	229	-144	S-FS-SNAP-M229-144	\$ 92.57	\$ 303.63

This Product is Available By-The-Foot / Metre. Larger IDs Available



Firesleeve with Metallic Zipper Closure

500°F / 260°C Continuous Rating – Higher Temperature for Shorter Periods

High Temperature, Heat, Flame & Fire Resistant Firesleeve

Removable silicone rubber coated fiberglass sleeve with snap closure provides heavy duty weld splatter & molten splash protection



This heavy duty silicone rubber coated fiberglass sleeve with high temperature zipper closures protects industrial wire, cable and hose with the benefits of being installed & removed as required. Typical applications are as robotic welding cable protection, steel mill roll-stand hydraulic hose protection or as a cover in extreme environments where serviceability is required. The zipper is made from high temperature Nomex®. This is a custom fabrication item – please allow 3 to 10 business days from date of order. Available in continuous lengths up to 150 feet. 500°F / 260°C continuous rating with weld splatter / molten metal splash protection

Also an excellent cold temperature sleeve with flexibility to -76°C for refrigeration and cryogenic applications.

**500°F / 260°C continuous rating with weld splatter / molten metal splash protection.
2200°F / 1205°C for periods up to 15 minutes and short excursions to 3000°F / 1650°C.**

Firesleeve with Metallic Zipper Closure (Continued)
500°F / 260°C Continuous Rating – Higher Temperature for Shorter Periods
High Temperature, Heat, Flame & Fire Resistant Firesleeve



ZipSleeve™ Firesleeve					
Heavy Duty Removable Molten Splash Protection Sleeve					
Nominal ID inches / mm / Dash #			Part Number	Price Per Foot	Price Per Metre
1	25	-16	S-FS-ZC-M025-16	\$ 20.29	\$ 66.55
1 1/4	32	-20	S-FS-ZC-M032-20	\$ 22.60	\$ 74.13
1 1/2	38	-24	S-FS-ZC-M038-24	\$ 24.83	\$ 81.44
1 3/4	44	-28	S-FS-ZC-M044-28	\$ 26.77	\$ 87.81
2	51	-32	S-FS-ZC-M051-32	\$ 29.00	\$ 95.12
2 1/4	57	-36	S-FS-ZC-M057-36	\$ 31.23	\$ 102.43
2 1/2	64	-40	S-FS-ZC-M064-40	\$ 33.49	\$ 109.85
2 3/4	70	-44	S-FS-ZC-M070-44	\$ 35.80	\$ 117.42
3	76	-48	S-FS-ZC-M076-48	\$ 37.94	\$ 124.44
3 1/4	83	-52	S-FS-ZC-M083-52	\$ 40.34	\$ 132.32
3 1/2	89	-56	S-FS-ZC-M089-56	\$ 42.29	\$ 138.71
3 3/4	95	-60	S-FS-ZC-M095-60	\$ 44.51	\$ 145.99
4	102	-64	S-FS-ZC-M102-64	\$ 48.37	\$ 158.65
4 1/4	108	-68	S-FS-ZC-M108-68	\$ 50.54	\$ 165.77
4 1/2	114	-72	S-FS-ZC-M114-72	\$ 52.94	\$ 173.64
4 3/4	121	-76	S-FS-ZC-M121-76	\$ 55.17	\$ 180.96
5	127	-80	S-FS-ZC-M127-80	\$ 57.54	\$ 188.73
5 1/4	133	-84	S-FS-ZC-M133-84	\$ 59.37	\$ 194.73
5 1/2	140	-88	S-FS-ZC-M140-88	\$ 61.66	\$ 202.25
5 3/4	146	-92	S-FS-ZC-M146-92	\$ 63.94	\$ 209.72
6	152	-96	S-FS-ZC-M152-96	\$ 66.11	\$ 216.84
6 1/4	159	-100	S-FS-ZC-M159-100	\$ 68.51	\$ 224.71
6 1/2	165	-104	S-FS-ZC-M165-104	\$ 70.74	\$ 232.03
6 3/4	171	-108	S-FS-ZC-M171-108	\$ 72.74	\$ 238.59
7	178	-112	S-FS-ZC-M178-112	\$ 74.97	\$ 245.90
7 1/4	184	-116	S-FS-ZC-M184-116	\$ 76.97	\$ 252.46
7 1/2	191	-120	S-FS-ZC-M191-120	\$ 79.54	\$ 260.89
7 3/4	197	-124	S-FS-ZC-M197-124	\$ 81.77	\$ 268.21
8	203	-128	S-FS-ZC-M203-128	\$ 83.69	\$ 274.50
8 1/4	210	-132	S-FS-ZC-M210-132	\$ 86.26	\$ 282.93
8 1/2	216	-136	S-FS-ZC-M216-136	\$ 88.43	\$ 290.05
8 3/4	222	-140	S-FS-ZC-M222-140	\$ 90.23	\$ 295.95
9	229	-144	S-FS-ZC-M229-144	\$ 92.57	\$ 303.63

This Product is Available By-The-Foot / Metre



Small Diameter Firesleeve for Wiring, Cable and Tubing Protection

464°F / 240°C Continuous Rating – Higher Temperature for Shorter Periods

High Temperature, Heat & Flame Resistant

Silicone Rubber Coated Fiberglass Sleeve with UL/CSA rating & NEMA TF-1



FlameShield™ small diameter firesleeve is designed as a primary insulation sleeve for protecting small diameter wire, cable, lines, hose, and pipe from high temperature, flame and environmental contamination. Recognized by UL / CSA for 240°C, 600V service, and complies with VW-1 flammability requirements. Conforms to, and is listed on the QPL for MIL-I-3190/9 (Grade A).

Extremely flexible and easily installed. Used in electrical apparatus as a primary or secondary wiring insulation.

The inner braid is very fine and dense, and along with the precision silicone rubber coating, this is the most flexible sleeve we have available for wire, cable and hose protection.

Due to the tight weave of this sleeve and the coating, it has negligible radial elasticity.

The coating of this sleeve provides excellent contamination resistance against oil, liquid splash, etc.

464°F / 240°C continuous rating with weld splatter / molten metal splash protection

Small Diameter Firesleeve for Wiring, Cable and Tubing Protection (Continued)

464°F / 240°C Continuous Rating – Higher Temperature for Shorter Periods

High Temperature, Heat & Flame Resistant

Available in all standard AWG wire sizes (see end of section): Available Colors are Oxide-Red and Black

<u>Property</u>	<u>Procedure</u>	<u>Performance</u>
<i>Physical</i>		
Tensile Strength, Coating	ASTM-D412	1600 psi
Ultimate Elongation, Coating	ASTM-D412	800% @ 20°C
Hardness, Coating	ASTM-D2240	54 (Durometer, Shore A)
Flexibility & Toughness, Coating	UL 1441	Passes Penetration Test
<i>Chemical</i>		
Oil & Solvent Resistance	MIL-I-3190/9	Passes
Water Vapour Resistance	MIL-I-3190/9	Passes
Resistance to Acids and Alkalis	-	Excellent
Resistance to Weathering	-	Unaffected by sunlight and weather
Compatibility	UL 1446	Good. Compatible with most potting compounds and varnishes
<i>Electrical</i>		
Dielectric Strength:		
after 48/23/50, Grade A	NEMA TF-1	8000V min avg., 6000v min individual
after 96/23/96, Grade A	NEMA TF-1	80% of Original Value
Hydrostatic Stability after 336 hrs @ 70°C over Constant Water Reflex	MIL-I-3190/9	Passes 7660V min avg with no disintegration, reversion or cracks (spec 5000V)
<i>Thermal</i>		
Thermal Endurance	MIL-I-3190/9 & UL 1441	Class 240°C (S)
Brittleness Temperature	ASTM-D350	-80°C
Flame Resistance	UL 1441	Passes (VW-1)
	ASTM-D350, Method A	Passes
	NEMA TF-1	Passes
	MIL-I-3190/9, Method A	Passes
Pushback	MIL-I-3190/9	No cracks or ruptures, 6000V min avg breakdown strength

This product is not stock, it is made to order: Delivery is approximately 10 business days.

Small Diameter Firesleeve (Continued)

High Temperature, Heat & Flame Resistant Small

Silicone Rubber Coated Fiberglass Sleeve

Primary Insulation Silicone Rubber Coated Fiberglass Sleeve for

Wire Protection, with UL/CSA approval rating and NEMA Grade TF-1 classified

**High Temperature - Small Diameter – NEMA Wall Thickness Sleeve
FlameShield™ Silicone Rubber Coated Fiberglass Sleeve with
UL/CSA rating and NEMA Grade TF-1 Classification**

Part Number	Nominal ID				Feet per Spool	Price per Spool
	AWG	Inches	mm	-dash		
S-FS-SD-AWG24-X	24	0.022	0.56		500*	\$ 488.05
S-FS-SD-AWG22-X	22	0.027	0.69		500*	\$ 490.17
S-FS-SD-AWG20-X	20	0.034	0.86		500*	\$ 505.01
S-FS-SD-AWG19-X	19	0.038	0.96		500*	\$ 510.02
S-FS-SD-AWG18-X	18	0.042	1.07		500*	\$ 525.65
S-FS-SD-AWG17-X	17	0.047	1.19		500*	\$ 535.27
S-FS-SD-AWG16-X	16	0.053	1.35		500*	\$ 545.79
S-FS-SD-AWG15-X	15	0.059	1.50		500*	\$ 550.33
S-FS-SD-AWG14-X	14	0.066	1.68	-01	500*	\$ 580.16
S-FS-SD-AWG13-X	13	0.076	1.93		250*	\$ 295.18
S-FS-SD-AWG12-X	12	0.085	2.16		250*	\$ 325.30
S-FS-SD-AWG11-X	11	0.095	2.41		250*	\$ 342.37
S-FS-SD-AWG10-X	10	0.106	2.69		250*	\$ 362.45
S-FS-SD-AWG9-X	9	0.118	3.10		250*	\$ 372.49
S-FS-SD-AWG8-X	8	0.133	3.38	-02	250*	\$ 402.61
S-FS-SD-AWG7-X	7	0.148	3.76		250*	\$ 430.72
S-FS-SD-AWG6-X	6	0.166	4.22		150*	\$ 274.83
S-FS-SD-AWG5-X	5	0.186	4.72	-03	150*	\$ 307.05
S-FS-SD-AWG4-X	4	0.208	5.28		150*	\$ 343.29
S-FS-SD-AWG3-X	3	0.234	5.94		150*	\$ 385.57
S-FS-SD-AWG2-X	2	0.263	6.68	-04	150*	\$ 454.03
S-FS-SD-AWG1-X	1	0.294	7.47		150*	\$ 520.47
S-FS-SD-05-X	5/16	0.313	7.95	-05	150*	\$ 567.78
S-FS-SD-AWG0-X	0	0.330	8.38		150	\$ 610.07
S-FS-SD-06-X	3/8	0.375	9.52	-06	150	\$ 853.69
S-FS-SD-07-X	7/16	0.438	11.12	-07	100	\$ 751.21
S-FS-SD-08-X	1/2	0.500	12.70	-08	100	\$ 877.72
S-FS-SD-10-X	5/8	0.625	15.87	-10	100	\$ 1068.93
S-FS-SD-12-X	3/4	0.750	19.05	-12	100	\$ 1258.32
S-FS-SD-14-X	7/8	0.875	22.22	-14	100	\$ 1534.66
S-FS-SD-16-X	1	1.000	25.40	-16	100	\$ 1874.27
S-FS-SD-18-X	1 1/8	1.125	28.57	-18	100	\$ 2603.51
S-FS-SD-20-X	1 1/4	1.250	31.75	-20	100	\$ 3062.44
S-FS-SD-22-X	1 3/8	1.375	34.92	-22	3**	\$ 33.37 / 3' section
S-FS-SD-23-X	1 7/16	1.437	36.49	-23	3**	\$ 36.88 / 3' section
S-FS-SD-24-X	1 1/2	1.500	38.10	-24	3**	\$ 39.83 / 3' section
S-FS-SD-26-X	1 5/8	1.625	41.27	-26	3**	\$ 42.99 / 3' section
S-FS-SD-28-X	1 3/4	1.750	44.45	-28	3**	\$ 46.46 / 3' section
S-FS-SD-30-X	1 7/8	1.875	47.62	-30	3**	\$ 50.17 / 3' section
S-FS-SD-32-X	2	2.000	50.80	-32	3**	\$ 57.31 / 3' section

See Page 1-43 for a table of pre-coated dimensional specifications for this product

For the "X" value in the part number, specify "B" for Black or "OR" for Oxide-Red Color.

This product is available in full coils only.

This product is not stock, it is made to order: Delivery is approximately 10 business days.

* Longer Spool Lengths Available. ** Minimum order 30 pieces



Small Diameter HD Wall Thickness Firesleeve for Wiring, Cable and Tubing Protection

-112 to +464°F / -80 to +240°C Operating Temperature – Higher Temperature for Shorter Periods

High Temperature, Heat & Flame Resistant

Heavy Wall Silicone Rubber Coated Fiberglass Sleeve with UL/CSA approved & NEMA TF-1 grade A



FlameShield™ small diameter firesleeve with Heavy Wall Silicone Rubber coating is designed as a primary insulation sleeve for protecting small diameter wire, cable, lines, hose, and pipe from high temperature, flame and environmental contamination. Recognized by UL / CSA for 240°C, 600V service, and meets VW-1 flammability requirements.

Extremely flexible and easily installed. Used in electrical apparatus as a primary or secondary wiring insulation.

The inner braid is very fine and dense, and along with the precision silicone rubber coating, this is the most flexible sleeve we have available for wire, cable and hose protection.

Due to the tight weave of this sleeve and thick silicone coating, it has negligible radial elasticity.

The coating of this sleeve provides excellent contamination resistance against oil, liquid splash, etc.

392°F / 200°C continuous rating with weld splatter / molten metal splash protection

Small Diameter HD Firesleeve

High Temperature, Heat & Flame Resistant Small

Silicone Rubber Coated Fiberglass Sleeve

Primary Insulation Silicone Rubber Coated Fiberglass Sleeve for

Wire Protection, with UL/CSA approval rating and NEMA Grade TF-1 classified

**High Temperature - Small Diameter – Heavy Wall Thickness Sleeve
FlameShield™ Silicone Rubber Coated Fiberglass Sleeve with
UL/CSA rating and NEMA Grade TF-1 Classification**

Part Number	Nominal ID				Price per Spool
	NEMA AWG Size	Inches	mm	-dash	
S-FS-SD-HDW-AWG24-X	24	0.022	0.56		By Quote
S-FS-SD-HDW-AWG22-X	22	0.027	0.69		By Quote
S-FS-SD-HDW-AWG20-X	20	0.034	0.86		By Quote
S-FS-SD-HDW-AWG19-X	19	0.038	0.96		By Quote
S-FS-SD-HDW-AWG18-X	18	0.042	1.07		By Quote
S-FS-SD-HDW-AWG17-X	17	0.047	1.19		By Quote
S-FS-SD-HDW-AWG16-X	16	0.053	1.35		By Quote
S-FS-SD-HDW-AWG15-X	15	0.059	1.50		By Quote
S-FS-SD-HDW-AWG14-X	14	0.066	1.68	-01	By Quote
S-FS-SD-HDW-AWG13-X	13	0.076	1.93		By Quote
S-FS-SD-HDW-AWG12-X	12	0.085	2.16		By Quote
S-FS-SD-HDW-AWG11-X	11	0.095	2.41		By Quote
S-FS-SD-HDW-AWG10-X	10	0.106	2.69		By Quote
S-FS-SD-HDW-AWG9-X	9	0.118	3.10		By Quote
S-FS-SD-HDW-AWG8-X	8	0.133	3.38	-02	By Quote
S-FS-SD-HDW-AWG7-X	7	0.148	3.76		By Quote
S-FS-SD-HDW-AWG6-X	6	0.166	4.22		By Quote
S-FS-SD-HDW-AWG5-X	5	0.186	4.72	-03	By Quote
S-FS-SD-HDW-AWG4-X	4	0.208	5.28		By Quote
S-FS-SD-HDW-AWG3-X	3	0.234	5.94		By Quote
S-FS-SD-HDW-AWG2-X	2	0.263	6.68	-04	By Quote
S-FS-SD-HDW-AWG1-X	1	0.294	7.47		By Quote
S-FS-SD-HDW-05-X	5/16	0.313	7.95	-05	By Quote
S-FS-SD-HDW-AWG0-X	0	0.330	8.38		By Quote
S-FS-SD-HDW-06-X	3/8	0.375	9.52	-06	By Quote
S-FS-SD-HDW-07-X	7/16	0.438	11.12	-07	By Quote
S-FS-SD-HDW-08-X	1/2	0.500	12.70	-08	By Quote
S-FS-SD-HDW-10-X	5/8	0.625	15.87	-10	By Quote
S-FS-SD-HDW-12-X	3/4	0.750	19.05	-12	By Quote
S-FS-SD-HDW-14-X	7/8	0.875	22.22	-14	By Quote
S-FS-SD-HDW-16-X	1	1.000	25.40	-16	By Quote
S-FS-SD-HDW-18-X	1 1/8	1.125	28.57	-18	By Quote
S-FS-SD-HDW-20-X	1 1/4	1.250	31.75	-20	By Quote
S-FS-SD-HDW-24-X	1 1/2	1.500	38.10	-24	By Quote

See Page 1-43 for a table of pre-coated dimensional specifications for this product

For the "X" value in the part number, specify "B" for Black or "OR" for Oxide-Red Color.

This product is available in full coils only.

This product is not stock, it is made to order: Delivery is approximately 10 business days.



Viton[®] 231 Coated Fiberglass Sleeve: AWG Wire Sized

High Temperature, Heat & Flame Resistant

428°F / 220°C: Continuous Rating – Higher Temperature for Shorter Periods

Cut, Puncture & Abrasion / Wear Resistance

Available meeting NEMA Grade A-1, B-1 & C-1



FlameShield™ Tuff-Flex™ Viton[®] coated sleeve is designed as a primary insulation sleeve for protecting small diameter wire, cable, lines, hose, and pipe from high temperature, flame and environmental contamination. Recognized by UL / CSA for 220°C, 7000V service, and complies with VW-1 flammability requirements. Conforms to, and is listed on the QPL for MIL-I-3190/9. Available in 3 grades: NEMA Grade A-1, B-1 and C-1.

Extremely flexible and easily installed. Used in electrical apparatus as a primary or secondary wiring insulation. Suitable for use in silicone free requirement environments. Resistance to solvents, both aromatic and aliphatic; fuels, including JP-5; and oils, including Skydrol.

The inner fiberglass braid is very fine and dense, and along with the precision Viton[®] 231 coating, this is the toughest cut and abrasion resistant flexible sleeve we have available for wire, cable and hose protection.

428°F / 220°C: Continuous Rating – Higher Temperature for Shorter Periods
Cut, Puncture & Abrasion / Wear Resistance

Viton® 231 Coated Fiberglass Sleeve: AWG Wire Sized
High Temperature, Heat & Flame Resistant (Continued)
428°F / 220°C: Continuous Rating – Higher Temperature for Shorter Periods
Cut, Puncture & Abrasion / Wear Resistance

Available in all standard AWG wire sizes (see end of this section): Available Colors are White, Black and Dark Tan (Natural).

<u>Property</u>	<u>Procedure</u>	<u>Performance</u>
Physical		
Tensile Strength, Coating	ASTM-D412	2000 psi @ 24°C; 600 psa @ 149°C
Ultimate Elongation, Coating	ASTM-D412	150% @ 24°C; 75% @ 149°C
Hardness, Coating	ASTM-D2240	80 (Durometer, Shore A)
Flexibility & Toughness, Coating	UL 1441	Passes Penetration Test
Chemical		
Oil & Solvent* Resistance	MIL-I-3190/9	Passes (excellent)
Water Vapour Resistance	MIL-I-3190/9	Passes (excellent)
Resistance to Acids and Alkalis	-	Excellent
Resistance to Weathering	-	Unaffected by sunlight and weather
Compatibility	UL 1446	Good. Compatible with most potting compounds and varnishes
Electrical		
Dielectric Strength:		
after 48/23/50, Grade A	NEMA TF-1	7000V min avg., 5000v min individual
after 96/23/96, Grade A	NEMA TF-1	80% of Original Value
Hydrostatic Stability after 336 hrs @ 70°C over Constant Water Reflex	MIL-I-3190/9	Passes 6000V min avg with no disintegration, reversion or cracks (spec 5000V)
Thermal		
Thermal Endurance	MIL-I-3190/9 & UL 1441	Class 220°C (R)
Brittleness Temperature	ASTM-D350	-70°C
Flame Resistance	UL 1441	Passes (VW-1)
	ASTM-D350, Method A	Passes
	NEMA TF-1	Passes
	MIL-I-3190/9, Method A	Passes
Pushback	MIL-I-3190/9	No cracks or ruptures, 6000V min avg breakdown strength

This product is not stock, it is made to order: Delivery is approximately 10 business days.

* Do not use Ketone type solvents as a cleaning agent; use V.M. & P. Naphtha.

Viton® 231 Coated Fiberglass Sleeve: AWG Wire Sized (Continued)

428°F / 220°C: High Temperature, Heat & Flame Resistant

Primary Insulation Viton® 231 Coated Fiberglass Sleeve for

Wire Protection, with UL/CSA approval rating and NEMA Grade A-1/B-1/C-1 classified

FlameShield™ High Temperature - Small Diameter – Viton® 231 Coated Fiberglass Sleeve with UL/CSA rating and NEMA Grade A-1 / B-1 / C-1 Classification. High Cut & Abrasion Resistance						
Part Number	Nominal ID AWG / Inches / mm / -dash				Feet per Spool	Price per 100 feet A-1 / B-1 / C-1
S-FG-VI-AWG24-X-Y	24	0.022	0.56		500*	\$ 465.94 / 372.76 / 233.04
S-FG-VI-AWG22-X-Y	22	0.027	0.69		500*	\$ 470.26 / 376.24 / 235.02*
S-FG-VI-AWG20-X-Y	20	0.034	0.86		500*	\$ 603.00 / 482.40 / 301.50
S-FG-VI-AWG19-X-Y	19	0.038	0.96		500*	\$ 607.63 / 486.30 / 303.95
S-FG-VI-AWG18-X-Y	18	0.042	1.07		500*	\$ 618.80 / 495.22 / 309.27
S-FG-VI-AWG17-X-Y	17	0.047	1.19		500*	\$ 649.95 / 520.13 / 324.97
S-FG-VI-AWG16-X-Y	16	0.053	1.35		500*	\$ 670.95 / 537.11 / 335.33
S-FG-VI-AWG15-X-Y	15	0.059	1.50		500*	\$ 680.40 / 544.47 / 340.17
S-FG-VI-AWG14-X-Y	14	0.066	1.68	-01	500*	\$ 702.90 / 562.42 / 351.27
S-FG-VI-AWG13-X-Y	13	0.076	1.93		250*	\$ 716.90 / 573.75 / 358.55
S-FG-VI-AWG12-X-Y	12	0.085	2.16		250*	\$ 747.87 / 598.17 / 374.07
S-FG-VI-AWG11-X-Y	11	0.095	2.41		250*	\$ 784.57 / 627.67 / 392.25
S-FG-VI-AWG10-X-Y	10	0.106	2.69		250*	\$ 827.45 / 662.02 / 413.70
S-FG-VI-AWG9-X-Y	9	0.118	3.10		250*	\$ 874.32 / 699.42 / 437.40
S-FG-VI-AWG8-X-Y	8	0.133	3.38	-02	250*	\$ 930.37 / 744.27 / 465.20
S-FG-VI-AWG7-X-Y	7	0.148	3.76		250*	\$ 948.21 / 758.45 / 474.15
S-FG-VI-AWG6-X-Y	6	0.166	4.22		150*	\$ 981.20 / 785.10 / 490.62
S-FG-VI-AWG5-X-Y	5	0.186	4.72	-03	150*	\$ 1010.90 / 808.77 / 505.62
S-FG-VI-AWG4-X-Y	4	0.208	5.28		150*	\$ 1017.95 / 814.32 / 508.70
S-FG-VI-AWG3-X-Y	3	0.234	5.94		150*	\$ 1065.80 / 852.75 / 532.95
S-FG-VI-AWG2-X-Y	2	0.263	6.68	-04	150*	\$ 1097.75 / 878.17 / 548.85
S-FG-VI-AWG1-X-Y	1	0.294	7.47		150*	\$ 1266.72 / 1013.32 / 633.30
S-FG-VI-05-X-Y	5/16	0.313	7.95	-05	150*	\$ 1436.75 / 1149.22 / 718.35
S-FG-VI-AWG0-X-Y	0	0.330	8.38		150	\$ 1605.07 / 1284.12 / 802.47
S-FG-VI-06-X-Y	3/8	0.375	9.52	-06	150	\$ 1841.02 / 1472.75 / 920.52
S-FG-VI-07-X-Y	7/16	0.438	11.12	-07	100	\$ 2365.92 / 1892.70 / 1183.05
S-FG-VI-08-X-Y	1/2	0.500	12.70	-08	100	\$ 3242.62 / 2593.92 / 1621.20
S-FG-VI-10-X-Y	5/8	0.625	15.87	-10	100	\$ 3943.80 / 3155.10 / 1972.02
S-FG-VI-12-X-Y	3/4	0.750	19.05	-12	100	\$ 4556.25 / 3644.97 / 2278.12
S-FG-VI-14-X-Y	7/8	0.875	22.22	-14	100	\$ 5608.47 / 4486.62 / 2804.30
S-FG-VI-16-X-Y	1	1.000	25.40	-16	100	\$ 6834.82 / 5468.12 / 3417.42
S-FG-VI-18-X-Y	1 1/8	1.125	28.57	-18	100	\$ N/A / 6589.25 / 4118.15
S-FG-VI-20-X-Y	1 1/4	1.250	31.75	-20	100	\$ N/A / 7851.07 / 4906.80
S-FG-VI-22-X-Y	1 3/8	1.375	34.92	-22	3**	\$ N/A. / N/A / 6134.17
S-FG-VI-23-X-Y	1 7/16	1.437	36.49	-23	3**	\$ N/A. / N/A / 6572.31
S-FG-VI-24-X-Y	1 1/2	1.500	38.10	-24	3**	\$ N/A. / N/A / 7010.82
S-FG-VI-26-X-Y	1 5/8	1.625	41.27	-26	3**	\$ N/A. / N/A / 7404.66
S-FG-VI-28-X-Y	1 3/4	1.750	44.45	-28	3**	\$ N/A. / N/A / 7799.31
S-FG-VI-30-X-Y	1 7/8	1.875	47.62	-30	3**	\$ N/A. / N/A / 8412.27
S-FG-VI-32-X-Y	2	2.000	50.80	-32	3**	\$ N/A. / N/A / 8982.45

Quantity Pricing: For 1000 to 4999 feet -10% / For 5000 feet or more -17%
 See end of section 1 for a table of pre-coated dimensional specifications for this product

For the "X" value, specify "A1", "B1" or "C1"
 For the "Y" value in the part number, specify "B" for Black or "W" for White or "N" for Natural (Dark Tan)

**This product is available in full coils only.
 This product is not generally stock: Delivery is approximately 15 business days.**

* Longer Spool Lengths Available. ** Minimum order 30 pieces



High Elasticity Firesleeve

392°F / 200°C: Continuous Rating – Higher Temperature for Shorter Periods

StretchSleeve™ High Temperature, Heat & Flame Resistant Super Stretch

Expandable Sleeve:

Silicone Rubber Coated Expandable Fiberglass Sleeve

with UL/CSA rating & NEMA Grade A



This specially designed sleeve is recommended for sleeving applications, which require a snug fit over irregular shapes.

This sleeve proves a “heat shrink” like fit while still providing flexibility, abrasion resistance, moisture resistance, uv, ozone and chemical resistance.

This sleeve can expand to twice its relaxed diameter.

Electrically rated to +200°C, but can provide higher temperature performance if the electrical properties are not required.

Provides dielectric grade A, NEMA TF-1, Type 5; Mil-I-3190/6 (Grade A).

StretchSleeve™ High Temperature, Heat & Flame Resistant Expandable Silicone Rubber Coated Fiberglass Sleeve

Part Number	Size		I.D. in inches		Spool Size feet	Price per Spool
	AWG	Range	Relaxed	Expanded		
S-FS-HiElas-13-X	#13	#13 - #7	0.076	0.144	250	\$ 69.53
S-FS-HiElas-9-X	#9	#9 - #3	0.118	0.229	250	call
S-FS-HiElas-6-X	#6	#6 - #1	0.166	0.289	250	call
S-FS-HiElas-3-X	#3	#3 - .437"	0.234	0.437	250	call
S-FS-HiElas-0-X	#0	#0 - .625"	0.330	0.625	100	call
S-FS-HiElas-375-X	.375"	.375" - .750"	0.375	0.750	100	\$ 286.95
S-FS-HiElas-500-X	.500"	.500" - 1.00"	0.500	1.000	100	\$ 439.71
S-FS-HiElas-625-X	.625"	.625" - 1.25"	0.625	1.250	100	\$ 536.31

For X: use "WH" for White. Use "BK" for Black

High Elasticity Firesleeve (Continued)

392°F / 200°C: Continuous Rating – Higher Temperature for Shorter Periods

StretchSleeve™ High Temperature, Heat & Flame Resistant Super Stretch Expandable Sleeve:

Silicone Rubber Coated Expandable Fiberglass Sleeve with UL/CSA rating & NEMA Grade A



Coating: 30 durometer, shore A; tensile strength >1000 psi; Elongation > 600%; Tear strength 150 ppi; Available in Black or White.

Electrical

Dielectric Strength:

after 48/23/50, Grade A

after 96/23/96, Grade A

NEMA TF-1

NEMA TF-1

8000V min avg., 6000v min individual

80% of Original Value

Hydrostatic Stability after 336 hrs
@ 70°C over Constant Water Reflex

MIL-I-3190/9

Passes 7660V min avg with no
disintegration, reversion or cracks
(spec 5000V)

Flame Resistance

NEMA TF-1

Passes

MIL-I-3190/9, Method A

Passes

Pushback

MIL-I-3190/9

No cracks or ruptures, 6000V min avg
breakdown strength

PTFE Coated Fiberglass Braided Sleeve

550°F / 287°C: Continuous Rating – Higher Temperature for Shorter Periods

DeltaGlass™ High Temperature, Heat & Chemical Resistant Sleeve



- Available in 1/16" – 1.59mm & 1/8" - 3.18mm wall thickness
- PTFE coating

Excellent resistance to almost all solvents, caustics and acids.

The base yarn is rated to 1200°F / 648°C. The PTFE coating melting point is 620°F / 327°C.

550°F / 287°C continuous rating, high insulation value & excellent personnel protection

This sleeve is an excellent choice for applications requiring a PTFE seal at high temperatures, as the sleeve's fiberglass base material supports the PTFE and reduces creep of the PTFE at high temperatures.

PTFE Coated Fiberglass Braided Sleeve (Continued)

550°F / 287°C: Continuous Rating – Higher Temperature for Shorter Periods

DeltaGlass™ High Temperature, Heat & Chemical Resistant Sleeve



**PTFE Coated Fiberglass Braided Sleeve
High-Temperature, Heat & Chemical Resistance**

Part Number	Size in / mm / -dash#			Feet per Spool Thin Wall / Thick Wall	Price / foot Thin wall	Price / foot Thick wall
S-FG-PTFE-M006-04-X	.250	6	-04	1400 / 700	\$ 1.68	\$ 3.28
S-FG-PTFE-M010-06-X	.375	10	-06	1400 / 600	\$ 1.88	\$ 3.64
S-FG-PTFE-M013-08-X	.500	13	-08	1000 / 330	\$ 2.44	\$ 6.16
S-FG-PTFE-M016-10-X	.625	16	-10	900 / 315	\$ 3.28	\$ 6.60
S-FG-PTFE-M019-12-X	.750	19	-12	750 / 300	\$ 3.88	\$ 6.64
S-FG-PTFE-M022-14-X	.875	22	-14	650 / 300	\$ 4.40	\$ 6.72
S-FG-PTFE-M025-16-X	1.000	25	-16	500 / 290	\$ 5.32	\$ 7.28
S-FG-PTFE-M032-20-X	1.250	32	-20	450 / 280	\$ 6.24	\$ 7.92
S-FG-PTFE-M038-24-X	1.500	38	-24	350 / 225	\$ 7.68	\$ 9.36
S-FG-PTFE-M041-26-X	1.625	41	-26	300 / 208	\$ 7.72	\$ 9.43
S-FG-PTFE-M044-28-X	1.750	44	-28	300 / 208	\$ 8.12	\$ 9.92
S-FG-PTFE-M051-32-X	2.000	51	-32	250 / 190	\$ 9.98	\$ 13.40
S-FG-PTFE-M057-36-X	2.250	57	-36	250 / 190	\$ 10.31	\$ 14.11
S-FG-PTFE-M064-40-X	2.500	64	-40	225 / 180	\$ 11.88	\$ 14.52
S-FG-PTFE-M070-44-X	2.750	70	-44	225 / 180	\$ 12.03	\$ 15.48
S-FG-PTFE-M076-48-X	3.000	76	-48	200 / 175	\$ 13.12	\$ 18.16
S-FG-PTFE-M083-52-X	3.250	83	-52	200 / 175	\$ 13.43	\$ 18.58
S-FG-PTFE-M089-56-X	3.500	89	-56	190 / 170	\$ 14.24	\$ 19.56
S-FG-PTFE-M095-60-X	3.750	95	-60	190 / 170	\$ 15.09	\$ 20.16
S-FG-PTFE-M102-64-X	4.000	102	-64	175 / 140	\$ 17.28	\$ 22.12
S-FG-PTFE-M114-72-X	4.500	114	-72	175 / 140	\$ 20.66	\$ 29.23
S-FG-PTFE-M127-80-X	5.000	127	-80	120 / 100	\$ 24.76	\$ 37.68

For the “X” value, use “1” to specify Thin Wall; use “2” to specify Thick Wall

Thin Wall = 1/16” / 1.59mm • Thick Wall = 1/8” / 3.18mm / This Product is Available By-The-Foot

The PTFE is applied to the sleeve through a proprietary sinterization process. The result is a PTFE coating on the sleeve which is soft, robust and flexible; however, it can be abrasively removed from the sleeve with aggressive fingernail scraping, resulting in a thinner and thinner layer of PTFE remaining with each pass. The PTFE also causes the yarns to be sealed and the small gaps between the yarns filled, resulting in an almost air-tight / liquid-tight sleeve wall.

Fiberglass Fabric with PTFE Resin Coating Sleeve with VELCRO® Brand Hook & Loop Closure

550°F / 287°C: Continuous Rating – Higher Temperature for Shorter Periods
Scuff-Sleeve™ VC



- Specialty protection for hoses, wire and cables.
- Sleeve with Velcro for easy retrofit.
- Sleeve is made from fiberglass base fabric impregnated with a PTFE resin coating. Excellent chemical resistance. Temperature range - 60°F to +550°F. Excellent UV protection. Not for use near open flame or welding.
- Used for food processing robot cables, lines and hoses.
- Washdown resistant
- Removeable for machine cleaning

Fiberglass Fabric with PTFE Resin Coating Sleeve with VELCRO® Brand Closure (Continued)

550°F / 287°C: Continuous Rating – Higher Temperature for Shorter Periods

Scuff-Sleeve™ VC



Sold in 50 foot increments up to 150 feet continuous rolls. Available in standard sizes; larger or custom sizes can be easily fabricated if required. Helps to organize and bundle hoses and cables.

Scuff-Sleeve™ VC: PTFE Impregnated Fiberglass Fabric Specialty Protection Sleeve with VELCRO® Brand Hook & Loop Closure				
Part Number	Size			Price per Foot
	inch / mm / -dash			FG/PTFE resin
S-FG-PTFE-VCL-M025-16 *	1.00	25	-16	\$ 12.03
S-FG-PTFE-VCL-M051-32	2.00	51	-32	\$ 15.60
S-FG-PTFE-VCL-M064-40	2.50	64	-40	\$ 16.76
S-FG-PTFE-VCL-M070-44	2.75	70	-44	\$ 18.28
S-FG-PTFE-VCL-M076-48	3.00	76	-48	\$ 19.55
S-FG-PTFE-VCL-M083-52	3.25	83	-52	\$ 20.36
S-FG-PTFE-VCL-M089-56	3.50	89	-56	\$ 21.47
S-FG-PTFE-VCL-M102-64	4.00	102	-64	\$ 22.36
S-FG-PTFE-VCL-M127-80	5.00	127	-80	\$ 23.84
S-FG-PTFE-VCL-M152-96	6.00	152	-96	\$ 24.91
S-FG-PTFE-VCL-M178-112	7.00	165	-104	\$ 31.40
S-FG-PTFE-VCL-M203-128	8.00	203	-128	\$ 32.37

Custom sizes available

Width of the Velcro is 1.5" except part numbers indicated with (*) which is .75".

Kevlar® Braided Aramid Sleeve - Standard Wall

320°F / 160°C: Continuous Rating – Higher Temperature for Shorter Periods

FlameShield™ High Temperature, Heat Resistant High Strength & Cut Resistant

Expandable Sleeve - Premium Grade – Standard Wall Thickness

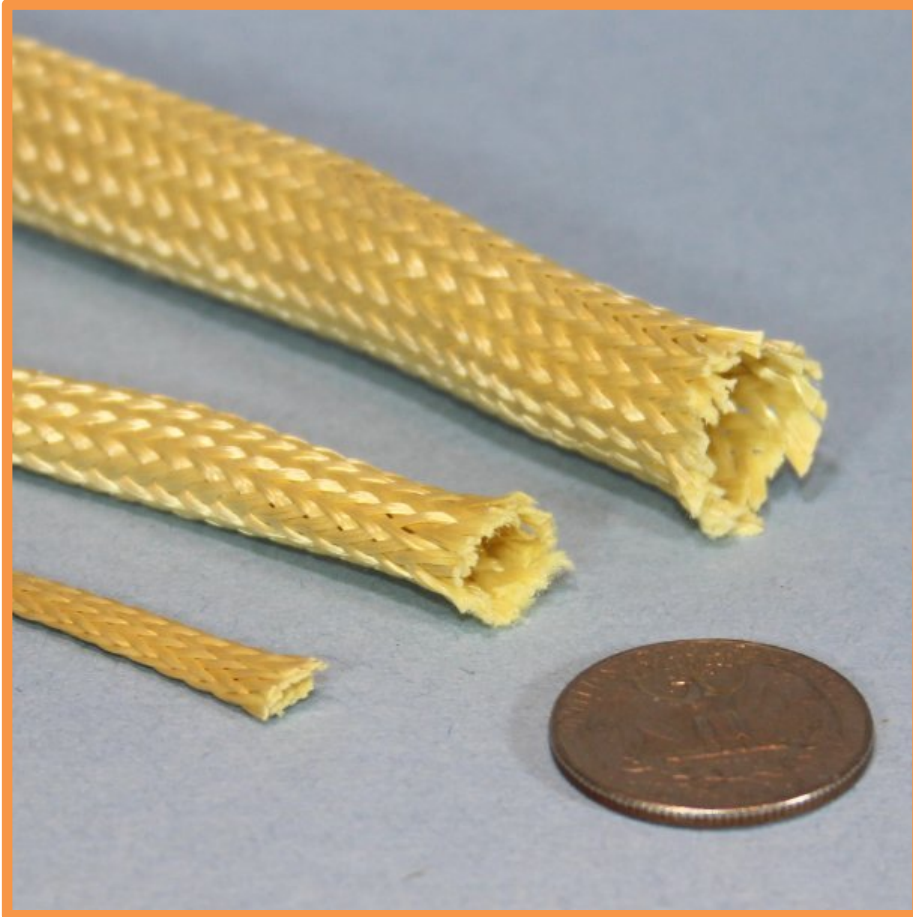

Kevlar sleeve is soft and pliable, highly flexible.

Halogen & asbestos free.

Fibers are 20 times stronger than steel for the same diameter. Highly cut resistant.

Braid angle allows this sleeve to expand/contract slightly to accommodate irregular surfaces and turns, splices and in-line connectors. Expansion does cause surface coverage to reduce slightly.

Available in natural (yellow) color.

.045" / 1.14 mm wall thickness.

This product is made from genuine Kevlar®.

**320°F / 160°C maximum continuous rating with high insulation value
& excellent personnel protection. Short term exposure to 572°F / 300°C**

Kevlar® Braided Aramid Sleeve - Standard Wall (Continued)
320°F / 160°C: Continuous Rating – Higher Temperature for Shorter Periods
FlameShield™ High Temperature, Heat Resistant High Strength & Cut Resistant
Expandable Sleeve - Premium Grade – Standard Wall Thickness



FlameShield™ High Temperature & Heat Resistant Braided Kevlar® Aramid Sleeve – Standard Wall – Premium Grade

Part Number	Nominal ID	Size Range	Spool Length in feet Bulk / Small	Price per Spool Bulk Spool / Small Spool
S-K-SW-M006-04-X	1/4" / 6 mm	1/8" to 5/16"	500 / 50	\$ 291.25 / \$ 42.37
S-K-SW-M013-08-X	1/2" / 13 mm	5/16" to 5/8"	250 / 50	\$ 373.76 / \$ 87.25
S-K-SW-M019-12-X	3/4" / 19 mm	9/16" to 1"	250 / 50	\$ 561.24 / \$ 124.75
S-K-SW-M025-16-X	1" / 25 mm	3/4" to 1 1/8"	200 / 25	\$ 599.21 / \$ 87.37
S-K-SW-M032-20-X	1 1/4" / 32 mm	1" to 1 1/2"	125 / 25	\$ 467.54 / \$ 106.43
S-K-SW-M038-24-X	1 1/2" / 38 mm	1 1/4" to 1 3/4"	100 / 25	\$ 516.75 / \$ 141.70
S-K-SW-M044-28-X	1 3/4" / 44 mm	1 1/2" to 2"	100 / 25	\$ 650.00 / \$ 195.00
S-K-SW-M051-32-X	2" / 51 mm	1 3/4" to 2 1/4"	100 / 25	\$ 801.37 / \$ 212.75
S-K-SW-M064-40-X	2 1/2" / 64 mm	2 1/4" to 2 3/4"	100 / 25	\$ 847.50 / \$ 254.25
S-K-SW-M076-48-X	3" / 76 mm	2 3/4" to 3 1/4"	100 / 25	\$ 1052.50 / \$ 315.75
S-K-SW-M089-56-X	3 1/2" / 89 mm	3 1/4" to 3 3/4"	100 / 25	\$ 1477.50 / \$ 443.25
S-K-SW-M102-64-X	4" / 102 mm	3 3/4" to 4 1/4"	100 / 25	\$ 1712.50 / \$ 513.75

For the "X" value: "F" for By-The-Foot followed by length in feet (example: F66 = 66 feet)
 use "B" for Bulk Spool size, use "S" for Small Spool size

This Product is available only in full Spools



Kevlar products are difficult to cut due to their strength. Regular or heavy duty scissors can sometimes cut these materials, but often fail quickly as the Kevlar quickly dulls the cutting edge.

Kevlar Shears are specifically designed to cut Kevlar, and feature a serrated blade (or dual serrated blades) so that the fibers don't slip while cutting, holding the fiber in position and allowing for a greater shear force to be applied by the opposing blade.

These shears are Extra Heavy Duty, and can be used for other materials such as cutting steel wires and steel tie wraps. Part number TL-S-KEV-HD. Priced from \$52.00 to \$79.00 depending on blade length.

Kevlar® is a registered trademark of E. I. Du Pont de Nemours and Company

Kevlar® Braided Aramid Sleeve – Colored - Standard Wall Thickness

320°F / 160°C: Continuous Rating – Higher Temperature for Shorter Periods

FlameShield™ High Temperature, Heat Resistant High Strength &

Cut Resistant Expandable Sleeve - Premium Grade – Standard Wall Thickness



- Kevlar sleeve is soft and pliable, highly flexible.
- Halogen & asbestos free.
- Fibers are 20 times stronger than steel for the same diameter. Highly cut resistant.
- Braid angle allows this sleeve to expand/contract slightly to accommodate irregular surfaces and turns, splices and in-line connectors. Expansion does cause surface coverage to reduce slightly.
- Available in 5 colors. The colored sleeve is made by adding a saturant which make the sleeve stiffer than non colored sleeve.
- .045" / 1.14 mm wall thickness.
- This product is made from genuine Kevlar® aramid yarns. Kevlar® is a registered trademark of DuPont.

**320°F / 160°C maximum continuous rating with high insulation value
& excellent personnel protection. Short term exposure to 572°F / 300°C**

Kevlar® Braided Aramid Sleeve – (Continued)

Colored - Standard Wall Thickness

320°F / 160°C: Continuous Rating – Higher Temperature for Shorter Periods

FlameShield™ High Temperature, Heat Resistant High Strength &

Cut Resistant Expandable Sleeve - Premium Grade – Standard Wall Thickness

FlameShield™ High Temperature & Heat Resistant Braided Kevlar® Aramid Sleeve - Premium					
Part Number	Nominal ID	Size Range	Spool Length in feet Bulk / Small	Colored Sleeve Price per Spool Bulk Spool / Small Spool	
S-K-SWC-M006-04-X-Y	1/4" / 6 mm	1/8" to 5/16"	500 / 50	\$ 931.50 / \$ 110.40	
S-K-SWC-M013-08-X-Y	1/2" / 13 mm	5/16" to 5/8"	250 / 50	\$ 884.25 / \$ 209.60	
S-K-SWC-M019-12-X-Y	3/4" / 19 mm	9/16" to 1"	250 / 50	\$ 972.00 / \$ 115.20	
S-K-SWC-M025-16-X-Y	1" / 25 mm	¾" to 1 1/8"	200 / 25	\$ 1080.00 / \$ 160.00	
S-K-SWC-M032-20-X-Y	1 1/4" / 32 mm	1" to 1 ½"	125 / 25	\$ 786.38 / \$ 186.40	
S-K-SWC-M038-24-X-Y	1 1/2" / 38 mm	1 ¼" to 1 ¾"	100 / 25	\$ 723.60 / \$ 186.40	
S-K-SWC-M044-28-X-Y	1 3/4" / 44 mm	1 ½ to 2"	100 / 25	\$ 877.50 / \$ 260.00	
S-K-SWC-M051-32-X-Y	2" / 51 mm	1 3/4" to 2 1/4"	100 / 25	\$ 1012.50 / \$ 300.00	
S-K-SWC-M064-40-X-Y	2 1/2" / 64 mm	2 ¼" to 2 ¾"	100 / 25	\$ 1144.80 / \$ 339.20	
S-K-SWC-M076-48-X-Y	3" / 76 mm	2 ¾" to 3 ¼"	100 / 25	\$ 1420.20 / \$ 420.80	
S-K-SWC-M089-56-X-Y	3 1/2" / 89 mm	3 ¼" to 3 ¾"	100 / 25	\$ 1995.30 / \$ 591.20	
S-K-SWC-M102-64-X-Y	4" / 102 mm	3 ¾" to 4 ¼"	100 / 25	\$ 2311.20 / \$ 684.80	

For the "X" value: use "B" for Bulk Spool size, use "S" for Small Spool size

For the "Y" value use OR - Orange, BK - Black, BL - Blue, RD - Red and GR - Green, YL-Yellow

This Product is available only in Spool Lengths



Kevlar products are difficult to cut due to their strength. Regular or heavy duty scissors can sometimes cut these materials, but often fail quickly as the Kevlar quickly dulls the cutting edge.

Kevlar Shears are specifically designed to cut Kevlar, and feature a serrated blade (or dual serrated blades) so that the fibers don't slip while cutting, holding the fiber in position and allowing for a greater shear force to be applied by the opposing blade.

These shears are Extra Heavy Duty, and can be used for other materials such as cutting steel wires and steel tie wraps. Part number TL-S-KEV-HD. Priced from \$52.00 to \$79.00 depending on blade length.

Kevlar® is a registered trademark of E. I. Du Pont de Nemours and Company



Kevlar® Braided Aramid Sleeve - Thin Wall

320°F / 160°C: Continuous Rating – Higher Temperature for Shorter Periods
FlameShield™ High Temperature, Heat Resistant High Strength & Cut Resistant Expandable Sleeve - Premium Grade – Standard Wall Thickness

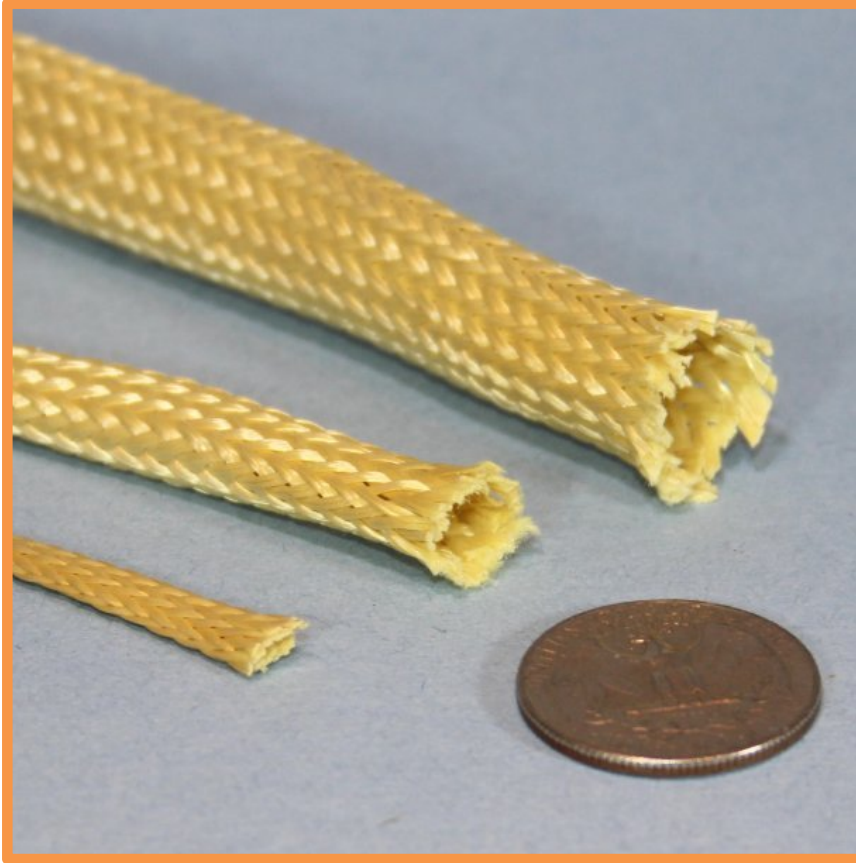

- Kevlar sleeve is soft, pliable, and highly flexible.
- Halogen & asbestos free.
- Fibers are 20 times stronger than steel for the same diameter..
- Highly cut resistant.
- Braid angle allows this sleeve to expand slightly to accommodate irregular surfaces and turns, splices and in-line connectors. Expansion does cause surface coverage to reduce.
- Available in natural (yellow) color.
- .02" / 0.508 mm wall thickness.

**320°F / 160°C maximum continuous rating with high insulation value
& excellent personnel protection. Short term exposure to 572°F / 300°C**

Kevlar® Braided Aramid Sleeve - Thin Wall (Continued)

320°F / 160°C: Continuous Rating – Higher Temperature for Shorter Periods

FlameShield™ High Temperature, Heat Resistant High Strength &

Cut Resistant Expandable Sleeve - Premium Grade – Standard Wall Thickness

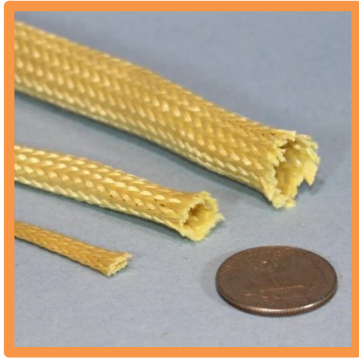

FlameShield™ High Temperature & Heat Resistant Braided Kevlar® Aramid Sleeve - Premium

Part Number	Nominal ID	Size Range	Spool Length in feet Bulk / Small	Price per Spool Bulk Spool / Small Spool	Price per Foot
S-K-TW-M006-04-X	1/4" / 6 mm	1/8" to 5/16"	500 / 50	\$ 291.25 / \$ 42.37	\$ 1.68
S-K-TW-M013-08-X	1/2" / 13 mm	5/16" to 5/8"	250 / 50	\$ 373.76 / \$ 87.25	\$ 3.48
S-K-TW-M019-12-X	3/4" / 19 mm	9/16" to 1"	250 / 50	\$ 561.24 / \$ 124.75	\$ 4.98
S-K-TW-M025-16-X	1" / 25 mm	3/4" to 1 1/8"	200 / 25	\$ 599.21 / \$ 87.37	\$ 6.98
S-K-TW-M032-20-X	1 1/4" / 32 mm	1" to 1 1/2"	125 / 25	\$ 467.54 / \$ 106.43	\$ 8.51
S-K-TW-M038-24-X	1 1/2" / 38 mm	1 1/4" to 1 3/4"	100 / 25	\$ 516.75 / \$ 141.70	\$ 11.23
S-K-TW-M051-32-X	2" / 51 mm	1 1/2" to 2"	100 / 25	\$ 801.37 / \$ 212.75	\$ 17.02

For the "X" value: "F" for By-The-Foot followed by length in feet (example: F66 = 66 feet)
use "B" for Bulk Spool size, use "S" for Small Spool size

This Product is available By-The-Foot and in Spools



Kevlar products are difficult to cut due to their strength. Regular or heavy duty scissors can sometimes cut these materials, but often fail quickly as the Kevlar quickly dulls the cutting edge.

Kevlar Shears are specifically designed to cut Kevlar, and feature a serrated blade (or dual serrated blades) so that the fibers don't slip while cutting, holding the fiber in position and allowing for a greater shear force to be applied by the opposing blade.

These shears are Extra Heavy Duty, and can be used for other materials such as cutting steel wires and steel tie wraps. Part number TL-S-KEV-HD. Priced from \$52.00 to \$79.00 depending on blade length.

Kevlar® is a registered trademark of E. I. Du Pont de Nemours and Company



Kevlar® Braided Aramid Sleeve - Heavy Wall

320°F / 160°C: Continuous Rating – Higher Temperature for Shorter Periods
FlameShield™ High Temperature, Heat Resistant, High Strength & Cut Resistant
Expandable Sleeve - Premium Grade – Heavy Wall Thickness

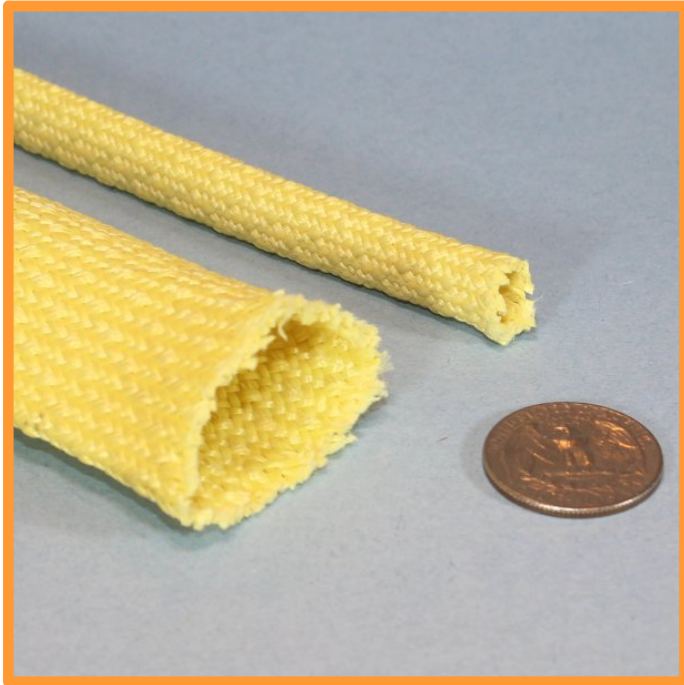

- Soft and pliable, highly flexible.
- Halogen & asbestos free.
- 20 times stronger than steel.
- Highly cut resistant.
- Braid angle allows this sleeve to expand to accommodate irregular surfaces and turns, splices and in-line connectors.
- Available in natural (yellow) color.
- .056" / 1.42 mm wall thickness.

320°F / 160°C maximum continuous rating with high insulation value & excellent personnel protection. Short term exposure to 572°F / 300°C

FlameShield™ High Temperature & Heat Resistant Braided Kevlar® Aramid Sleeve – Premium Heavy Wall

Part Number	Nominal ID	Size Range	Spool Length		Price per Spool Bulk Spool / Small Spool
			In feet Bulk / Small		
S-K-HD-M006-04-X	1/4" / 6 mm	1/4" to 3/8"	500 / 50		\$ 1397.82 / \$ 152.50
S-K-HD-M013-08-X	1/2" / 13 mm	1/2" to 1"	250 / 50		\$ 1250.05 / \$ 262.50
S-K-HD-M025-16-X	1" / 25 mm	1" to 1 3/4"	200 / 25		\$ 1424.67 / \$ 190.63
S-K-HD-M032-20-X	1 1/4" / 32 mm	1 1/4" to 2"	125 / 25		\$ 1103.72 / \$ 232.50

For the "X" value: use "F" for By-The-Foot followed by length in feet (example: F66 = 66 feet)
use "B" for Bulk Spool size, use "S" for Small Spool size

This Product is available in By-The-Foot lengths and spools



Kevlar products are difficult to cut due to their strength. Regular or heavy duty scissors can sometimes cut these materials, but often fail quickly as the Kevlar quickly dulls the cutting edge.

Kevlar Shears are specifically designed to cut Kevlar, and feature a serrated blade (or dual serrated blades) so that the fibers don't slip while cutting, holding the fiber in position and allowing for a greater shear force to be applied by the opposing blade.

These shears are Extra Heavy Duty, and can be used for other materials such as cutting steel wires and steel tie wraps. Part number TL-S-KEV-HD. Priced from \$52.00 to \$79.00 depending on blade length.

Kevlar® is a registered trademark of E. I. Du Pont de Nemours and Company

Nomex® Braided Sleeve

662°F / 350°C: Continuous Rating – Higher Temperature for Shorter Periods

FlameShield™ High Temperature, Heat & Flame Resistant Expandable Sleeve – Premium Grade



- Genuine Dupont Nomex®
- Soft and pliable.
- Halogen & asbestos free.
- 90,000 psi tensile strength.
- Cuts easily to length with scissors. Braid angle allows this sleeve to expand slightly to accommodate irregular surfaces and turns, splices and in-line connectors.
- Available in natural and green color.
- .016" wall thickness.

662°F / 350°C continuous rating, high insulation value & excellent personnel protection

FlameShield™ Braided Nomex® Sleeve High Temperature & Heat Resistant – Premium Grade			
Part Number	Nominal ID	Size Range	Price per Spool 100ft / 25ft
S-NMX-M003-02-X-Y	1/8"	1/16" to 1/4"	\$ 44.66 / \$ 23.53
S-NMX-M006-04-X-Y	1/4"	1/8" to 5/16"	\$ 180.25 / \$ 57.76
S-NMX-M008-05-X-Y	5/16"	7/32" to 7/16"	\$ 209.75 / \$ 64.90
S-NMX-M010-06-X-Y	3/8"	1/4" to 1/2"	\$ 240.00 / \$ 72.51
S-NMX-M013-08-X-Y	1/2"	5/16" to 5/8"	\$ 326.06 / \$ 94.05
S-NMX-M016-10-X-Y	5/8"	7/16" to 7/8"	\$ 415.33 / \$ 116.24
S-NMX-M019-12-X-Y	3/4"	9/16" to 1"	\$ 512.06 / \$ 140.52
S-NMX-M025-16-X-Y	1"	3/4" to 1 1/8"	\$ 865.75 / \$ 228.97
S-NMX-M032-20-X-Y	1 1/4"	1" to 1 1/2"	\$ 1250.25 / \$ 325.43
S-NMX-M038-24-X-Y	1 1/2"	1 1/4" to 1 3/4"	\$ 1442.75 / \$ 373.60
S-NMX-M044-28-X-Y	1 3/4"	1 1/2" to 2"	\$ 1707.22 / \$ 439.67

For the "X" value, use "100" for 100 foot spool, use "25" for 25 foot spool

For the "Y" value, use "NT" natural color, use "GN" for green color

Please call for additional discount pricing when ordering multiple spools.

This Product is NOT Available By-The-Foot – Spools Only



Fiberglass Knitted Sleeve: Premium Grade

1200°F / 648°C: Continuous Rating – Higher Temperature for Shorter Periods

DeltaGlass™ Very High Temperature & Heat Resistant Knitted Sleeve for Wire, Cable, Hose & Pipe / Tube protection and Personnel Burn Protection



This Knitted fiberglass sleeve is fabricated from high quality type E fiberglass that will not burn and will withstand continuous exposure to temperatures of 1200°F / 648°C.

This material resists most acids and alkalis and is unaffected by most bleaches and solvents. It is highly flexible and conformable.

The base fiber is manufactured to the specifications of ASTM D-578, ASTM committee D13, and subcommittee D13.18.

Knitted or Braided Fiberglass Sleeve is typically used to protect hoses, cables and wires from high temperatures up to 1200°F / 648°C continuous use.

1200°F / 648°C continuous rating, high insulation value & excellent personnel protection.

Knitted sleeve has an advantage over braided sleeve, as it is dimensionally stable and only minimally expandable compared to braided sleeve – it conforms well to the object over which it is placed without clamping to hold it onto the object.

This sleeve is commonly used to protect wire, cables and hoses from heat exposure. The construction of the sleeve provides a high bulk, ensuring a high insulation value. It can also be used in multiple layers to increase the total insulation value. Conversely, this sleeve can protect personnel from contact burns due to hot process hoses, tubing or lines.

The total sleeve thickness necessary to drop the surface temperature to the 140°F hot surface incidental contact temperature (OSHA generally accepted value) varies with the temperature of the hose or tube, the fluid flow rate, and ambient temperature; but as a general rule, a pipe or tube at 1000°F will require a 1" thickness of fiberglass insulation.

DeltaGlass™ Very High Temperature & Heat Resistant Knitted Fiberglass Sleeve – Premium Grade									
ID Size inch / mm / dash#			Part Number	Price per Foot / 100 ft length	ID Size inch / mm / dash#			Part Number	Price per Foot / 100 ft length
1/2"	13	-08	S-FG-KNIT-M013-08	\$ 2.66 / \$ 133.00	2 1/4"	57	-36	S-FG-KNIT-M057-36	\$ 10.20 / \$ 510.00
5/8"	16	-10	S-FG-KNIT-M016-10	\$ 2.94 / \$ 147.00	2 1/2"	64	-40	S-FG-KNIT-M064-40	\$ 13.20 / \$ 660.00
3/4"	19	-12	S-FG-KNIT-M019-12	\$ 3.34 / \$ 167.00	2 3/4"	70	-44	S-FG-KNIT-M070-44	\$ 16.86 / \$ 843.00
7/8"	22	-14	S-FG-KNIT-M022-14	\$ 3.94 / \$ 197.00	3"	76	-48	S-FG-KNIT-M076-48	\$ 19.00 / \$ 950.00
1"	25	-16	S-FG-KNIT-M025-16	\$ 4.54 / \$ 227.00	3 1/4"	83	-52	S-FG-KNIT-M083-52	\$ 20.34 / \$ 1017.00
1 1/4"	32	-20	S-FG-KNIT-M032-20	\$ 5.40 / \$ 270.00	3 1/2"	89	-56	S-FG-KNIT-M089-56	\$ 21.86 / \$ 1093.00
1 3/8"	35	-22	S-FG-KNIT-M035-22	\$ 5.54 / \$ 277.00	3 3/4"	95	-60	S-FG-KNIT-M095-60	\$ 22.66 / \$ 1133.00
1 1/2"	38	-24	S-FG-KNIT-M038-24	\$ 5.66 / \$ 283.00	4"	102	-64	S-FG-KNIT-M102-64	\$ 22.86 / \$ 1143.00
1 3/4"	44	-28	S-FG-KNIT-M044-28	\$ 7.34 / \$ 367.00	4 1/2"	114	-72	S-FG-KNIT-M114-72	\$ 26.26 / \$ 1313.00
1 7/8"	48	-30	S-FG-KNIT-M048-30	\$ 7.94 / \$ 397.00	5"	127	-80	S-FG-KNIT-M127-80	\$ 30.20 / \$ 1510.00
2"	51	-32	S-FG-KNIT-M051-32	\$ 8.54 / \$ 427.00	6"	152	-96	S-FG-KNIT-M152-96	\$ 36.20 / \$ 1810.00

Minimum order is 25 feet

DeltaGlass™ Knitted or Braided Fiberglass Sleeving is typically used to protect hoses, cables and wires from high temperatures up to 1200°F / 648°C continuous use.

Fiber Type:	E Glass	Specific Gravity:	2.54-2.69
Breaking Tenacity:	1.71 gf/TEX. Std. 1.71 gf/TEX Wet	Tensile Strength:	450,000-500,000 psi.
Breaking Elongation:	4.81% Std. 4.81% Wet	Elastic Recovery:	100%
Average Stiffness:	2824.3 cn/TEX		

Effect of Heat: Will not burn; Retains 75% tensile at 343°C; Softens at 732-877°C; Melts at 1121-1182°C
 Effect of Acids and Alkalis; Resistance to acids is fair. Good resistance to most alkalis.
 Effect of Bleaches and Solvents: Unaffected



Fiberglass Braided Sleeve: Premium Grade

1200°F / 648°C: Continuous Rating – Higher Temperature for Shorter Periods

DeltaGlass™ Very High Temperature Heat Resistant Braided Sleeve for Wire, Cable, Hose & Pipe / Tube protection and Personnel Burn Protection

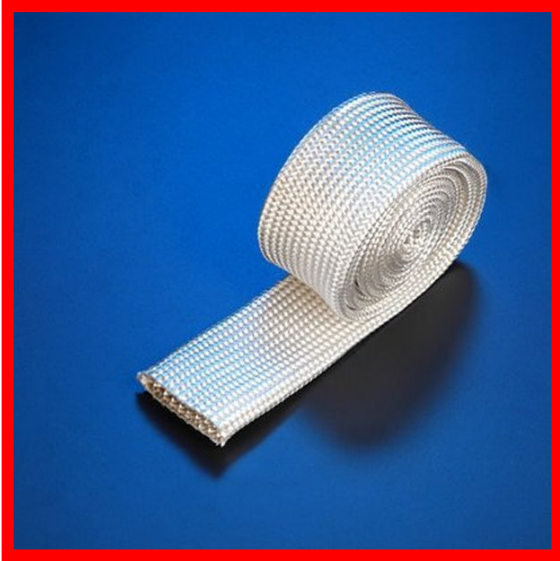

This Braided fiberglass sleeve is fabricated from high quality type E fiberglass that will not burn and will withstand continuous exposure to temperatures of 1200°F / 648°C.

This material resists most acids and alkalis and is unaffected by most bleaches and solvents. It is highly flexible and conformable.

The base fiber is manufactured to the specifications of ASTM D-578, ASTM committee D13, and subcommittee D13.18.

1200°F / 648°C continuous rating, high insulation value & excellent personnel protection

Both a Heat Treated and Heat Treated with Acrylic Saturant version of this product is available – please enquire

Braided sleeve has the ability to expand and contract a nominal amount, if expanded then the coverage of the braid is lower than if the sleeve is contracted.

This sleeve is commonly used to protect wire, cables and hoses from heat exposure. The construction of the sleeve provides a high bulk, ensuring a high insulation value. It can also be used in multiple layers to increase the total insulation value. Conversely, this sleeve can protect personnel from contact burns due to hot process hoses, tubing or lines.

The total sleeve thickness necessary to drop the surface temperature to the 140°F hot surface incidental contact temperature (OSHA generally accepted value) varies with the temperature of the hose or tube, the fluid flow rate, and ambient temperature; but as a general guide, a pipe or tube at 1000°F will require a 1" thickness of fiberglass insulation.

DeltaGlass™ Very High Temperature & Heat Resistant Braided Fiberglass Sleeve - Premium Grade

ID Size inch / mm / dash#			Part Number	Price per Foot / 100 ft spool	ID Size inch / mm / dash#			Part Number	Price per Foot / 100 ft spool
3/8	10	-06	S-FG-BRAID-M010-06	\$ 4.34 / \$ 217.00	1 7/8"	48	-30	S-FG-BRAID-M048-30	\$ 14.88 / \$ 744.00
1/2"	13	-08	S-FG-BRAID-M013-08	\$ 4.64 / \$ 232.00	2"	51	-32	S-FG-BRAID-M051-32	\$ 16.66 / \$ 833.00
5/8"	16	-10	S-FG-BRAID-M016-10	\$ 4.94 / \$ 247.00	2 1/4"	57	-36	S-FG-BRAID-M057-36	\$ 17.34 / \$ 867.00
3/4"	19	-12	S-FG-BRAID-M019-12	\$ 6.00 / \$ 300.00	2 1/2"	64	-40	S-FG-BRAID-M064-40	\$ 18.08 / \$ 904.00
7/8"	22	-14	S-FG-BRAID-M022-14	\$ 6.62 / \$ 331.00	2 3/4"	70	-44	S-FG-BRAID-M070-44	\$ 19.34 / \$ 967.00
1"	25	-16	S-FG-BRAID-M025-16	\$ 7.34 / \$ 367.00	3"	76	-48	S-FG-BRAID-M076-48	\$ 21.00 / \$ 1050.00
1 1/4"	32	-20	S-FG-BRAID-M032-20	\$ 8.66 / \$ 433.00	3 1/4"	83	-52	S-FG-BRAID-M083-52	\$ 23.00 / \$ 1150.00
1 3/8"	35	-22	S-FG-BRAID-M035-22	\$ 9.66 / \$ 483.00	3 1/2"	89	-56	S-FG-BRAID-M089-56	\$ 24.10 / \$ 1205.00
1 1/2"	38	-24	S-FG-BRAID-M038-24	\$ 10.66 / \$ 533.00	3 3/4"	95	-60	S-FG-BRAID-M095-60	\$ 24.86 / \$ 1243.00
1 3/4"	44	-28	S-FG-BRAID-M044-28	\$ 12.66 / \$ 633.00	4"	102	-64	S-FG-BRAID-M102-64	\$ 25.66 / \$ 1283.00

Minimum order is \$200.00. By-The-Foot sleeve may be mixed sizes to achieve minimum order.

DeltaGlass™ Knitted or Braided Fiberglass sleeve is typically used to protect hoses, cables and wires from high temperatures up to 1200°F / 648°C continuous use.

Fiber Type:	E Glass	Specific Gravity:	2.54-2.69
Breaking Tenacity:	1.71 gf/TEX. Std. 1.71 gf/TEX Wet	Tensile Strength:	450,000-500,000 psi.
Breaking Elongation:	4.81% Std. 4.81% Wet	Elastic Recovery:	100%
Average Stiffness:	2824.3 ch/TEX		

Effect of Heat: Will not burn; Retains 75% tensile at 343°C; Softens at 732-877°C; Melts at 1121-1182°C
 Effect of Acids and Alkalis; Resistance to acids is fair. Good resistance to most alkalis.
 Effect of Bleaches and Solvents: Unaffected



Fiberglass Braided Sleeve: Industrial Grade
1200°F / 648°C: Continuous Rating – Higher Temperature for Shorter Periods
DeltaGlass™ Very High Temperature & Heat Resistant



- DeltaGlass™ Braided Industrial sleeve
- Available in Thin Wall (1/16”) and Thick Wall (1/8”).

This braided sleeve is fabricated from high quality type E fiberglass that will not burn and will withstand continuous exposure to temperatures of 1200°F / 648°C.

This material resists most acids and alkalis and is unaffected by most bleaches and solvents. It is highly flexible and conformable. The base fiber is manufactured to the specifications of ASTM D-578, ASTM committee D13, and subcommittee D13.18.

A Heat Treated version of this product is available – please enquire

1200°F / 648°C continuous rating, high insulation value & excellent personnel protection

DeltaGlass™ Very High Temperature & Heat Resistant Fiberglass Braided Sleeve Industrial Grade							
Part Number	Size inch / mm / -dash			Thin Wall		Thick Wall	
				Feet / Metres per spool	Price per Foot / Metre	Feet / Metres per spool	Price per Foot / Metre
S-FG-BI-M006-04-X	.250	6	-4	1400 / 426	\$ 0.56 / \$ 1.84	700 / 213	\$ 1.08 / \$ 3.54
S-FG-BI-M010-06-X	.375	10	-6	1400 / 426	\$ 0.76 / \$ 2.49	600 / 182	\$ 1.20 / \$ 3.94
S-FG-BI-M013-08-X	.500	13	-8	1000 / 304	\$ 0.92 / \$ 3.02	330 / 100	\$ 2.00 / \$ 6.56
S-FG-BI-M016-10-X	.625	16	-10	900 / 274	\$ 0.96 / \$ 3.15	315 / 96	\$ 2.16 / \$ 7.09
S-FG-BI-M019-12-X	.750	19	-12	750 / 228	\$ 1.01 / \$ 3.31	300 / 91	\$ 2.18 / \$ 7.15
S-FG-BI-M022-14-X	.875	22	-14	650 / 198	\$ 1.12 / \$ 3.67	300 / 91	\$ 2.20 / \$ 7.22
S-FG-BI-M025-16-X	1.000	25	-16	500 / 152	\$ 1.52 / \$ 4.99	290 / 88	\$ 2.40 / \$ 7.87
S-FG-BI-M032-20-X	1.250	32	-20	450 / 137	\$ 1.80 / \$ 5.90	280 / 85	\$ 2.60 / \$ 8.53
S-FG-BI-M038-24-X	1.500	38	-24	350 / 106	\$ 2.36 / \$ 7.74	225 / 68	\$ 3.04 / \$ 9.97
S-FG-BI-M044-28-X	1.750	44	-28	300 / 91	\$ 2.52 / \$ 8.27	208 / 63	\$ 3.24 / \$ 10.63
S-FG-BI-M051-32-X	2.000	51	-32	250 / 76	\$ 2.64 / \$ 8.66	190 / 57	\$ 4.36 / \$ 14.30
S-FG-BI-M064-40-X	2.500	64	-40	225 / 68	\$ 2.96 / \$ 9.71	180 / 54	\$ 4.76 / \$ 15.61
S-FG-BI-M076-48-X	3.000	76	-48	200 / 60	\$ 3.20 / \$ 10.50	175 / 53	\$ 5.92 / \$ 19.42
S-FG-BI-M089-56-X	3.500	89	-56	190 / 57	\$ 3.56 / \$ 11.68	170 / 51	\$ 6.40 / \$ 20.99
S-FG-BI-M102-64-X	4.000	102	-64	175 / 53	\$ 5.88 / \$ 19.29	140 / 42	\$ 7.20 / \$ 23.62
S-FG-BI-M127-80-X	5.000	127	-80	120 / 36	\$ 6.16 / \$ 20.21	100 / 30	\$ 12.28 / \$ 40.28

**For the “X” value in the part number:
 use “1” to specify Thin Wall; use “2” to specify Thick Wall**

Thin Wall = 1/16” / 1.59mm • Thick Wall = 1/8” / 3.18mm

This Product is Available By-The-Foot

Fiberglass Braided Heat Treated Sleeve: Premium Grade
1200°F / 648°C: Continuous Rating – Higher Temperature for Shorter Periods
DeltaGlass™ Very High Temperature & Heat Resistant – Passes UL VW-1 Flame Test



This Braided fiberglass sleeve is fabricated from high quality type E fiberglass that will not burn and will withstand continuous exposure to temperatures of 1200°F / 648°C.

Heat Treating removes organics and impurities from the sleeve, and makes the product dimensionally stable to the high-end of its continuous exposure temperature (providing minimal shrinkage). The sleeve is exceptionally smooth and has extremely few loose filament ends protruding from the braid – making it extremely clean to use in a variety of applications including aerospace wiring protection and bundling and clean room applications.

This material resists most acids and alkalis and is unaffected by most bleaches and solvents. It is highly flexible and conformable.

The braiding is fine and dense, providing excellent protective coverage. Common applications for heat treated sleeve is for the protection of wiring, cables and hoses in consumer, industrial and commercial appliances and equipment such as ovens, kilns, toasters and heaters. The base fiber is manufactured to the specifications of ASTM D-578, ASTM committee D13, and subcommittee D13.18.

1200°F / 648°C continuous rating, high insulation value & excellent personnel protection

Very High Temperature & Heat Resistant
Fiberglass Braided Heat Treated Sleeve – Premium Grade
UL 1441 (VW-1) / Dielectric C-3 / UL Thermal Class S & C

Part Number	ID Size in / mm / dash #	Feet / Metres per Spool	Price Spool / Foot
S-FG-BHT-M006-04	0.250 / 6 / -4	500 / 152	\$ 815.00 / \$4.08
S-FG-BHT-M010-06	0.375 / 10 / -6	500 / 152	\$ 915.00 / \$4.58
S-FG-BHT-M013-08	0.500 / 13 / -8	400 / 121	\$ 997.00 / \$6.25
S-FG-BHT-M016-10	0.625 / 16 / -10	500 / 152	\$ 1,565.00 / \$7.83
S-FG-BHT-M019-12	0.750 / 19 / -12	400 / 121	\$ 1,332.00 / \$8.33
S-FG-BHT-M025-16	1.000 / 25 / -16	250 / 76	\$ 1,092.50 / \$10.93
S-FG-BHT-M038-24	1.500 / 38 / -24	200 / 60	\$ 1,500.00 / \$18.75

Please call for additional discount pricing when ordering more than 5 spools.

This Product is available By-The-Foot and by Spool Length



Braided Fiberglass Sleeve – Texturized - High Bulk

1200°F / 648°C: Continuous Rating – Higher Temperature for Shorter Periods

MaxSleeve™ Temperature & Heat Resistant Fiberglass Braided High Bulk Texturized Sleeve: Premium Grade



- MaxSleeve™ Braided High Bulk Texturized Premium Sleeve.
- Highest Insulation Value Sleeve Available.
- Available in Thin Wall (1/16”) and Thick Wall (1/8”).
- Texturization provides high bulk & high thermal insulation value

This braided sleeve is fabricated from high quality type E fiberglass that will not burn and will withstand continuous exposure to temperatures of 1200°F / 648°C.

This material resists most acids and alkalis and is unaffected by most bleaches and solvents. It is highly flexible and conformable. The base fiber is manufactured to the specifications of ASTM D-578, ASTM committee D13, and subcommittee D13.18.

Available Plain and Vermiculite Coated.

1200°F / 648°C continuous rating, high insulation value & excellent personnel protection

MaxSleeve™ High Bulk Texturized Braided Fiberglass Sleeve Premium Grade

Part Number	Size inch / mm / -dash			Thin Wall		Thick Wall	
				Feet / Metres per spool	Price per Spool	Feet / Metres per spool	Price per Spool
S-FG-TEX-M010-06-X	.375	10	-6	N/A	N/A	250 / 76	\$ 717.50
S-FG-TEX-M013-08-X	.500	13	-8	500 / 152	\$ 740.00	250 / 76	\$ 787.50
S-FG-TEX-M016-10-X	.625	16	-10	N/A	N/A	100 / 30	\$ 495.00
S-FG-TEX-M019-12-X	.750	19	-12	250 / 76	\$ 587.50	100 / 30	\$ 540.00
S-FG-TEX-M025-16-X	1.000	25	-16	250 / 76	\$ 675.00	100 / 30	\$ 585.00
S-FG-TEX-M032-20-X	1.250	32	-20	N/A	N/A	100 / 30	\$ 630.00
S-FG-TEX-M038-24-X	1.500	38	-24	250 / 76	\$ 787.50	100 / 30	\$ 675.00
S-FG-TEX-M051-32-X	2.000	51	-32	N/A	N/A	100 / 30	\$ 743.00

**For the “X” value in the part number:
use “1” to specify Thin Wall; use “2” to specify Thick Wall**

Thin Wall = 1/16” / 1.59mm • Thick Wall = 1/8” / 3.18mm

Fiberglass Braided Anti-Fray Expandable Heat Treated & Saturated Sleeve - Premium Grade

1200°F / 648°C: Continuous Rating – Higher Temperature for Shorter Periods
 DeltaGlass™ Very High Temperature & Heat Resistant Expandable Sleeve



This Braided fiberglass sleeve is fabricated from high quality type E fiberglass that will not burn and will withstand continuous exposure to temperatures of 1200°F / 648°C. The sleeve is heat treated before being saturated.

This material resists most acids and alkalis and is unaffected by most bleaches and solvents. It is highly flexible and conformable.

The base fiber is manufactured to the specifications of ASTM D-578, ASTM committee D13, and subcommittee D13.18.

The braid angle of this sleeve allows for the sleeve to easily adjust to a range of sizes around its nominal ID – so it can accommodate passing over splices and in-line connectors.

The saturant provides reduced fray when cutting this sleeve, as can be seen by the clean ends of the sleeve in this photo. As well, the sleeve becomes stiffer (notice the sleeve remains tubular and does not collapse under its own weight as it would unsaturated). The sleeve remains highly conformable and flexible even with the saturant; it flexes, bends with the same radius as unsaturated sleeve and curves easily and will not prevent or restrict wiring and cable routing.

1200°F / 648°C continuous rating, high insulation value & excellent personnel protection

Very High Temperature & Heat Resistant Braided Heat Treated Fiberglass with Acrylic Saturated Sleeve Premium Grade				
Part Number		Size Range	Feet / Metres per Spool	Price per Spool
S-FG-B-HT-SAT-M006/010-04/06	¼" / 6mm	1/4" to 3/8"	600 / 182	\$ 690.00
S-FG-B-HT-SAT-M010/013-06/08	3/8" / 10mm	3/8" to 1/2"	400 / 121	\$ 748.00
S-FG-B-HT-SAT-M013/019-08/12	½" / 13mm	1/2" to 3/4"	300 / 91	\$ 891.00
S-FG-B-HT-SAT-M016/025-10/16	5/8" / 16mm	5/8" to 1"	250 / 76	\$ 995.00
S-FG-B-HT-SAT-M019/032-12/20	¾" / 19mm	3/4" to 1 1/4"	250 / 76	\$ 1,332.50
S-FG-B-HT-SAT-M025/044-16/28	1" / 25mm	1" to 1 3/4"	200 / 60	\$ 1,584.00
S-FG-B-HT-SAT-M038/057-24/36	1 ½" / 38mm	1 1/2" to 2 1/4"	150 / 45	\$ 1,828.50
S-FG-B-HT-SAT-M064/102-40/64	2 ½" / 64mm	2 1/2" to 4"	75 / 22	\$ 1,464.75

The addition of an acrylic saturant adds rigidity and abrasive resistance to the sleeve, reducing the likelihood of end fray and results in a sleeve that is easy to apply over long lengths of hose or cable.

The base material temperature rating is 1200°F / 648°C, however the saturant will smoke off at temperatures above 425F / 218°C.

The large braid angle allows for significant expansion of the sleeve resulting in ease of installation, for example, in situations where a hose may have an in-line coupling or adapter to a larger size hose; or similarly where cables may have a splice.

This Product is NOT Available By-The-Foot – Full Spool Only



Fiberglass Braided Sleeve - AWG Wire Gauge Sized - E Glass & S Glass Precision Small Diameter

1200°F / 648°C: Continuous Rating – Higher Temperature for Shorter Periods
DeltaGlass™ Very High Temperature & Heat Resistant Insulation with 1375 volts
space factor rating and NEMA TF-2 Section 6.3 flame resistance

S-Glass Precision Small Diameter / NEMA Wall Thickness:
Plain or Heat Treated, Heat Treated with Binders

E-Glass Precision Small Diameter / Heavy Wall:
Heat Treated or Heat Treated with Binders



Left: Standard Wall Thickness
Right: 1/32" Heavy Wall Thickness



Standard Wall Thickness
Heat Treated with Binders

Plain & heat treated sleeve is 1200°F / 648°C continuous, 1742°F / 950°C intermittent.

Sleeve with binders is rated to 600°F / 316°C continuous, 1140°F / 616°C intermittent.

This is a high-strength, high-temperature fiberglass sleeve produced from either S-Glass or E-Glass. S-Glass, which in addition to enhanced dielectric and mechanical properties, provides thermal protection beyond the limits of conventional E-glass fibers. S-Glass is free of boron and will not decompose to form gaseous products with nuclear radiation exposure. Also available heat treated; with Acrylic resin or Oleoresinous binder. Both heat treated and with binders reduces fray and makes cutting easier.

The braiding is tight and dense, providing excellent coverage over small wires, cables, hoses, tubes and pipes.

Properties:

	S Glass	E Glass
Specific Gravity g/cm ³ :	2.48 – 2.49	2.55 - 2.58
Elongation at break, %:	5.3 – 5.7	4.5 - 4.9
Tensile strength, psi @22°C:	650,000 – 700,000	500,000 - 550,000
Water absorbency @22°C, 65% R.H.:	None	None
Space Factor Insulation, volts:	1375	1100 (Std Wall) 1500 (HD wall)

Common Properties:

Good resistance to most acids and alkalies
Unaffected by bleaches and solvents
Excellent resistance to sunlight and aging. Not attacked by Mildew.
Conforms to NEMA TF-2. Fibers conform to MIL-R-60346. Type IV, Class 1.

This product is not stock, it is made to order: Delivery is approximately 15 business days.

**Very High Temperature & Heat Resistant Fiberglass Braided Sleeve
S-Glass Precision Small Diameter / NEMA Wall Thickness: Plain or Heat Treated
with 1375 volts space factor insulation and NEMA TF-2 section 6.3 flame rating**

Part Number	Nominal Size AWG / inch / mm / -dash				Price per Spool		Feet per Spool
					Plain	Heat Treated	
S-FG-S-AWG24-X	24	0.022	0.56	NA	\$ 192.38	\$ 233.46	500'
S-FG-S-AWG22-X	22	0.027	0.69	NA	\$ 207.41	\$ 243.48	500'
S-FG-S-AWG20-X	20	0.034	0.86	NA	\$ 212.42	\$ 253.50	500'
S-FG-S-AWG19-X	19	0.038	0.96	NA	\$ 222.44	\$ 258.51	500'
S-FG-S-AWG18-X	18	0.042	1.07	NA	\$ 237.47	\$ 278.55	500'
S-FG-S-AWG17-X	17	0.047	1.19	NA	\$ 252.50	\$ 298.59	500'
S-FG-S-AWG16-X	16	0.053	1.35	NA	\$ 287.57	\$ 338.67	500'
S-FG-S-AWG15-X	15	0.059	1.50	NA	\$ 322.64	\$ 383.76	500'
S-FG-S-AWG14-X	14	0.066	1.68	-01	\$ 357.71	\$ 418.83	500'
S-FG-S-AWG13-X	13	0.076	1.93	NA	\$ 199.79	\$ 233.92	250'
S-FG-S-AWG12-X	12	0.085	2.16	NA	\$ 214.85	\$ 255.01	250'
S-FG-S-AWG11-X	11	0.095	2.41	NA	\$ 232.92	\$ 275.59	250'
S-FG-S-AWG10-X	10	0.106	2.69	NA	\$ 244.97	\$ 290.55	250'
S-FG-S-AWG9-X	9	0.118	3.10	NA	\$ 269.07	\$ 318.26	250'
S-FG-S-AWG8-X	8	0.133	3.38	-02	\$ 292.16	\$ 348.38	250'
S-FG-S-AWG7-X	7	0.148	3.76	NA	\$ 312.24	\$ 374.48	250'
S-FG-S-AWG6-X	6	0.166	4.22	NA	\$ 203.34	\$ 238.57	150'
S-FG-S-AWG5-X	5	0.186	4.72	-03	\$ 221.46	\$ 264.74	150'
S-FG-S-AWG4-X	4	0.208	5.28	NA	\$ 243.61	\$ 289.91	150'
S-FG-S-AWG3-X	3	0.234	5.94	NA	\$ 276.83	\$ 327.16	150'
S-FG-S-AWG2-X	2	0.263	6.68	-04	\$ 311.06	\$ 367.43	150'
S-FG-S-AWG1-X	1	0.294	7.47	NA	\$ 350.32	\$ 414.74	150'
S-FG-S-05-X	5/16	0.313	7.95	-05	\$ 380.52	\$ 444.94	150'
S-FG-S-AWG0-X	0	0.330	8.38	NA	\$ 407.70	\$ 478.17	150'
S-FG-S-06-X	3/8	0.375	9.52	-06	\$ 767.10	\$ 897.96	150'
S-FG-S-07-X	7/16	0.438	11.12	-07	\$ 618.21	\$ 737.34	100'
S-FG-S-08-X	1/2	0.500	12.70	-08	\$ 786.35	\$ 919.33	100'
S-FG-S-10-X	5/8	0.625	15.87	-10	\$ 942.74	\$ 1104.21	100'
S-FG-S-12-X	3/4	0.750	19.05	-12	\$ 1192.11	\$1239.54	100'
S-FG-S-14-X	7/8	0.875	22.22	-14	\$ 1298.63	\$1519.79	100'
S-FG-S-16-X	1	1.000	25.40	-16	\$ 1530.84	\$1791.54	100'

**For the "X" value in the part number: use "P" to specify Plain
use "HT" to specify Heat Treated**

- See table at end of section for dimensional specifications for this product.
- Plain & Heat Treated sleeve is 1200°F / 648°C continuous, 1742°F / 950°C intermittent.
- This product is available in full coils except as listed below.

By The Foot Pricing:

S-FG-S-AWG16-HT is available at \$3.55 per foot.
S-FG-S-AWG10-HT is available at 5.94 per foot

- **This product is not stock, it is made to order: Delivery is approximately 10 business days.**

Very High Temperature & Heat Resistant Fiberglass Braided Sleeve
S-Glass Precision Small Diameter / NEMA Wall Thickness
with 1375 volts space factor insulation and NEMA TF-2 section 6.3 flame rating
Heat Treated with Binders

Part Number	Nominal Size				Price per Spool	Feet per Spool
	AWG	inch	mm	-dash		
S-FG-S-HTB-AWG24-X	24	0.022	0.56	NA	\$ 255.51	500'
S-FG-S-HTB-AWG22-X	22	0.027	0.69	NA	\$ 270.54	500'
S-FG-S-HTB-AWG20-X	20	0.034	0.86	NA	\$ 275.55	500'
S-FG-S-HTB-AWG19-X	19	0.038	0.96	NA	\$ 290.58	500'
S-FG-S-HTB-AWG18-X	18	0.042	1.07	NA	\$ 305.61	500'
S-FG-S-HTB-AWG17-X	17	0.047	1.19	NA	\$ 335.67	500'
S-FG-S-HTB-AWG16-X	16	0.053	1.35	NA	\$ 375.75	500'
S-FG-S-HTB-AWG15-X	15	0.059	1.50	NA	\$ 415.83	500'
S-FG-S-HTB-AWG14-X	14	0.066	1.68	-01	\$ 460.92	500'
S-FG-S-HTB-AWG13-X	13	0.076	1.93	NA	\$ 257.03	250'
S-FG-S-HTB-AWG12-X	12	0.085	2.16	NA	\$ 275.10	250'
S-FG-S-HTB-AWG11-X	11	0.095	2.41	NA	\$ 300.20	250'
S-FG-S-HTB-AWG10-X	10	0.106	2.69	NA	\$ 320.28	250'
S-FG-S-HTB-AWG9-X	9	0.118	3.10	NA	\$ 350.40	250'
S-FG-S-HTB-AWG8-X	8	0.133	3.38	-02	\$ 377.51	250'
S-FG-S-HTB-AWG7-X	7	0.148	3.76	NA	\$ 410.64	250'
S-FG-S-HTB-AWG6-X	6	0.166	4.22	NA	\$ 264.76	150'
S-FG-S-HTB-AWG5-X	5	0.186	4.72	-03	\$ 289.93	150'
S-FG-S-HTB-AWG4-X	4	0.208	5.28	NA	\$ 316.11	150'
S-FG-S-HTB-AWG3-X	3	0.234	5.94	NA	\$ 358.39	150'
S-FG-S-HTB-AWG2-X	2	0.263	6.68	-04	\$ 405.70	150'
S-FG-S-HTB-AWG1-X	1	0.294	7.47	NA	\$ 459.06	150'
S-FG-S-HTB-05-X	5/16	0.313	7.95	-05	\$ 493.29	150'
S-FG-S-HTB-AWG0-X	0	0.330	8.38	NA	\$ 526.51	150'
S-FG-S-HTB-06-X	3/8	0.375	9.52	-06	\$ 993.62	150'
S-FG-S-HTB-07-X	7/16	0.438	11.12	-07	\$ 815.21	100'
S-FG-S-HTB-08-X	1/2	0.500	12.70	-08	\$ 1017.55	100'
S-FG-S-HTB-10-X	5/8	0.625	15.87	-10	\$ 1221.71	100'
S-FG-S-HTB-12-X	3/4	0.750	19.05	-12	\$ 1546.92	100'
S-FG-S-HTB-14-X	7/8	0.875	22.22	-14	\$ 1683.68	100'
S-FG-S-HTB-16-X	1	1.000	25.40	-16	\$ 1984.17	100'

For the "X" value in the part number:

use "HTA" to specify Heat Treated plus Acrylic Resin Binder

- Resin treated available in white, red, green, brown, yellow, black, blue.

use "HTO" to specify Heat Treated with Oleoresinous Varnish Binder

- See table at the end of this section for dimensional tolerances for this product
- Plain & heat treated sleeve is rated 1200°F / 648°C continuous, 1742°F / 950°C intermittent.
- Sleeve with binders is rated to 600°F / 316°C continuous, 1140°F / 616°C intermittent
- Full spools only.
- **This product is not stock, it is made to order: Delivery is approximately 10 business days.**

Very High Temperature & Heat Resistant Fiberglass Braided Sleeve
E-Glass Precision Small Diameter / Standard Wall Thickness
Heat Treated or Heat Treated with Binders
with NEMA classification & Meets MIL-Y-1140 Class C Form 1
Meets UL 1441 VW-1 Flame Resistance – Will Not Burn

Part Number	Nominal Size AWG / inch / mm / -dash				Price per Spool		Feet per Coil
					Heat Treated	Heat Treated with Binders	
S-FG-E-AWG24-X	24	0.022	0.56	NA	\$ 117.00	\$ 146.25	500'
S-FG-E-AWG22-X	22	0.027	0.69	NA	\$ 120.25	\$ 149.50	500'
S-FG-E-AWG20-X	20	0.034	0.86	NA	\$ 123.63	\$ 152.75	500'
S-FG-E-AWG19-X	19	0.038	0.96	NA	\$ 126.75	\$ 156.00	500'
S-FG-E-AWG18-X	18	0.042	1.07	NA	\$ 130.00	\$ 159.25	500'
S-FG-E-AWG17-X	17	0.047	1.19	NA	\$ 133.25	\$ 162.50	500'
S-FG-E-AWG16-X	16	0.053	1.35	NA	\$ 136.50	\$ 169.00	500'
S-FG-E-AWG15-X	15	0.059	1.50	NA	\$ 143.12	\$ 175.50	500'
S-FG-E-AWG14-X	14	0.066	1.68	-01	\$ 146.25	\$ 182.00	500'
S-FG-E-AWG13-X	13	0.076	1.93	NA	\$ 73.13	\$ 92.62	250'
S-FG-E-AWG12-X	12	0.085	2.16	NA	\$ 74.75	\$ 97.50	250'
S-FG-E-AWG11-X	11	0.095	2.41	NA	\$ 81.25	\$ 107.25	250'
S-FG-E-AWG10-X	10	0.106	2.69	NA	\$ 82.87	\$ 108.87	250'
S-FG-E-AWG9-X	9	0.118	3.10	NA	\$ 89.37	\$ 113.75	250'
S-FG-E-AWG8-X	8	0.133	3.38	-02	\$ 95.87	\$ 126.75	250'
S-FG-E-AWG7-X	7	0.148	3.76	NA	\$ 104.00	\$ 134.87	250'
S-FG-E-AWG6-X	6	0.166	4.22	NA	\$ 68.25	\$ 86.77	150'
S-FG-E-AWG5-X	5	0.186	4.72	-03	\$ 74.10	\$ 94.57	150'
S-FG-E-AWG4-X	4	0.208	5.28	NA	\$ 79.95	\$ 105.30	150'
S-FG-E-AWG3-X	3	0.234	5.94	NA	\$ 92.62	\$ 115.05	150'
S-FG-E-AWG2-X	2	0.263	6.68	-04	\$ 102.37	\$ 133.57	150'
S-FG-E-AWG1-X	1	0.294	7.47	NA	\$ 117.97	\$ 151.12	150'
S-FG-E-05-X	5/16	0.313	7.95	-05	\$ 135.52	\$ 177.45	150'
S-FG-E-AWG0-X	0	0.330	8.38	NA	\$ 163.80	\$ 190.12	150'
S-FG-E-06-X	3/8	0.375	9.52	-06	\$ 193.05	\$ 250.57	150'
S-FG-E-07-X	7/16	0.438	11.12	-07	\$ 145.60	\$ 183.95	100'
S-FG-E-08-X	1/2	0.500	12.70	-08	\$ 155.35	\$ 195.65	100'
S-FG-E-10-X	5/8	0.625	15.87	-10	\$ 167.70	\$ 211.90	100'
S-FG-E-12-X	3/4	0.750	19.05	-12	\$ 206.70	\$ 259.35	100'
S-FG-E-14-X	7/8	0.875	22.22	-14	\$ 228.15	\$ 287.95	100'
S-FG-E-16-X	1	1.000	25.40	-16	\$ 277.55	\$ 349.05	100'

For the "X" value in the part number:

use "HT" to specify Heat Treated

use "HTA" to specify Heat Treated plus Acrylic Resin Binder,

use "HTAF" to specify Heat Treated plus Acrylic Resin Flexible Binder

- Resin treated available in white, red, green, brown, yellow, black, blue.

use "HTO" to specify Heat Treated with Oleoresinous Varnish Binder

Plain & Heat Treated sleeve is 1200°F / 648°C continuous, 1742°F / 950°C intermittent

Sleeve with binders is rated to 600°F / 316°C continuous, 1140°F / 616°C intermittent

See Size Table at the end of this catalog section for dimensional specifications

This Product must be purchased in full coils except as indicated below:

S-FG-E-AWG11-X is available by the foot; \$4.29 per foot

This product is not stock, it is made to order: Delivery is approximately 15 business days.

Very High Temperature & Heat Resistant Fiberglass Braided Sleeve
E-Glass Precision Small Diameter / Heavy Wall (1/32" - .031")
Heat Treated or Heat Treated with Binders
with NEMA classification & Meets MIL-Y-1140 Class C Form 1
Meets UL 1441 VW-1 Flame Resistance – Will Not Burn

Part Number	Nominal Size AWG / inch / mm / -dash				Price per Spool		Feet per Coil
					Heat Treated	Heat Treated with Binders	
S-FG-E-HD-AWG24-X	24	0.022	0.56	NA	\$ 180.00	\$ 225.00	500'
S-FG-E-HD-AWG22-X	22	0.027	0.69	NA	\$ 185.00	\$ 230.00	500'
S-FG-E-HD-AWG20-X	20	0.034	0.86	NA	\$ 195.00	\$ 235.00	500'
S-FG-E-HD-AWG19-X	19	0.038	0.96	NA	\$ 195.00	\$ 240.00	500'
S-FG-E-HD-AWG18-X	18	0.042	1.07	NA	\$ 200.00	\$ 245.00	500'
S-FG-E-HD-AWG17-X	17	0.047	1.19	NA	\$ 205.00	\$ 250.00	500'
S-FG-E-HD-AWG16-X	16	0.053	1.35	NA	\$ 210.00	\$ 260.00	500'
S-FG-E-HD-AWG15-X	15	0.059	1.50	NA	\$ 220.00	\$ 270.00	500'
S-FG-E-HD-AWG14-X	14	0.066	1.68	-01	\$ 225.00	\$ 280.00	500'
S-FG-E-HD-AWG13-X	13	0.076	1.93	NA	\$ 112.50	\$ 142.50	250'
S-FG-E-HD-AWG12-X	12	0.085	2.16	NA	\$ 115.00	\$ 150.00	250'
S-FG-E-HD-AWG11-X	11	0.095	2.41	NA	\$ 125.00	\$ 165.00	250'
S-FG-E-HD-AWG10-X	10	0.106	2.69	NA	\$ 127.50	\$ 167.50	250'
S-FG-E-HD-AWG9-X	9	0.118	3.10	NA	\$ 137.50	\$ 175.00	250'
S-FG-E-HD-AWG8-X	8	0.133	3.38	-02	\$ 147.50	\$ 195.00	250'
S-FG-E-HD-AWG7-X	7	0.148	3.76	NA	\$ 160.00	\$ 207.50	250'
S-FG-E-HD-AWG6-X	6	0.166	4.22	NA	\$ 105.00	\$ 133.50	150'
S-FG-E-HD-AWG5-X	5	0.186	4.72	-03	\$ 114.00	\$ 145.50	150'
S-FG-E-HD-AWG4-X	4	0.208	5.28	NA	\$ 123.00	\$ 162.00	150'
S-FG-E-HD-AWG3-X	3	0.234	5.94	NA	\$ 142.50	\$ 177.00	150'
S-FG-E-HD-AWG2-X	2	0.263	6.68	-04	\$ 157.50	\$ 205.50	150'
S-FG-E-HD-AWG1-X	1	0.294	7.47	NA	\$ 181.50	\$ 232.50	150'
S-FG-E-HD-05-X	5/16	0.313	7.95	-05	\$ 208.50	\$ 273.00	150'
S-FG-E-HD-AWG0-X	0	0.330	8.38	NA	\$ 252.00	\$ 292.50	150'
S-FG-E-HD-06-X	3/8	0.375	9.52	-06	\$ 297.00	\$ 385.50	150'
S-FG-E-HD-07-X	7/16	0.438	11.12	-07	\$ 224.00	\$ 283.00	100'
S-FG-E-HD-08-X	1/2	0.500	12.70	-08	\$ 239.00	\$ 301.00	100'
S-FG-E-HD-10-X	5/8	0.625	15.87	-10	\$ 258.00	\$ 326.00	100'
S-FG-E-HD-12-X	3/4	0.750	19.05	-12	\$ 318.00	\$ 399.00	100'
S-FG-E-HD-14-X	7/8	0.875	22.22	-14	\$ 351.00	\$ 443.00	100'
S-FG-E-HD-16-X	1	1.000	25.40	-16	\$ 427.00	\$ 537.00	100'

For the "X" value in the part number:

use "HT" to specify Heat Treated

use "HTA" to specify Heat Treated plus Acrylic Resin Binder,

use "HTAF" to specify Heat Treated plus Acrylic Resin Flexible Binder

- Resin treated available in white, red, green, brown, yellow, black, blue.

use "HTO" to specify Heat Treated with Oleoresinous Varnish Binder

Plain & heat treated sleeve is 1200°F / 648°C continuous, 1742°F / 950°C intermittent.

Sleeve with binders is rated to 600°F / 316°C continuous, 1140°F / 616°C intermittent

See Size Table at the end of this catalog section for a dimensional specifications

This Product must be purchased in full coils.

This product is not stock, it is made to order: Delivery is approximately 15 business days.

Fiberglass Braided Sleeve - Special Thin Wall .006" & .008".
Plain and with Binders - Precision Premium Grade
1200°F / 648°C: Continuous Rating – Higher Temperature for Shorter Periods
DeltaGlass™ Very High Temperature & Heat Resistant

Very High Temperature & Heat Resistant Fiberglass Braided Sleeve Special Thin Wall Thickness: Plain available all sizes; or with Resin Binder up to 1/2" / 12.7mm ID						
Part Number	ID Nominal Size inch / mm / -dash			Price per Spool		Feet per Spool
				.006 wall Plain / Resin	.008 wall Plain / Resin	
S-FG-E-TW-M0016-01-X-Y	1/16 / 0.063	1.68	-01	\$ 102.20 / \$ 137.90	\$ 120.30 / \$ 161.90	1200'
S-FG-E-TW-M003-02-X-Y	1/8 / 0.125	3.17	-02	\$ 176.60 / \$ 212.50	\$ 211.00 / \$ 252.40	1200'
S-FG-E-TW-M005-03-X-Y	3/16 / 0.188	4.76	-03	\$ 196.60 / \$ 228.30	\$ 264.30 / \$ 315.50	1200'
S-FG-E-TW-M006-04-X-Y	1/4 / 0.250	6.35	-04	\$ 236.60 / \$ 274.10	\$ 292.10 / \$ 330.60	1200'
S-FG-E-TW-M008-05-X-Y	5/16 / 0.313	7.93	-05	\$ 144.95 / \$ 163.15	\$ 184.75 / \$ 219.15	600'
S-FG-E-TW-M010-06-X-Y	3/8 / 0.375	9.52	-06	\$ 177.25 / \$ 197.55	\$ 223.30 / \$ 277.20	600'
S-FG-E-TW-M011-07-X-Y	7/16 / 0.438	11.11	-07	\$ 191.30 / N/A	\$ 254.00 / N/A	600'
S-FG-E-TW-M013-08-X-Y	1/2 / 0.500	12.7	-08	\$ 210.45 / \$ 234.05	\$ 278.90 / \$ 320.75	600'
Sizes Below Not Available in .006" wall or with Resin Binder						
S-FG-E-TW-M016-10-8	5/8 / 0.625	15.87	-10	N/A	\$ 191.12 / N/A	300'
S-FG-E-TW-M019-12-8	3/4 / 0.750	19.05	-12	N/A	\$ 208.15 / N/A	300'
S-FG-E-TW-M022-14-8	7/8 / 0.875	22.22	-14	N/A	\$ 230.83 / N/A	300'
S-FG-E-TW-M025-16-8	1 / 1.000	25.4	-16	N/A	\$ 277.25 / N/A	300'
S-FG-E-TW-M032-20-8	1 1/4 / 1.250	31.75	-20	N/A	\$ 297.37 / N/A	300'
S-FG-E TW-M038-24-8	1 1/2 / 1.500	38.1	-24	N/A	\$ 326.02 / N/A	300'

For the "X" value in the part number: use "8" to specify .008" wall
use "6" to specify .006" wall

For the "Y" value in the part number: use "P" to specify Plain
use "B" to specify with Binder

- Plain sleeve is 1200°F / 648°C continuous, 1742°F / 950°C intermittent.
- Sleeve with binders is rated to 600°F / 316°C continuous, 1140°F / 616°C intermittent.
- This product is available in full coils only.
- Resin treated available in white, red, green, brown, yellow, black, blue.
- This is not a stock item: approximately 10 business days to manufacture to order.

Acrylic Coated Fiberglass Sleeve - Flexible - AWG Small Diameter
311°F / 155°C: High Temperature, Heat & Flame Resistant – UL & CSA Recognized
Available meeting NEMA Grade F-A-1, F-B-1, F-C-1, F-C-2 & F-C-3

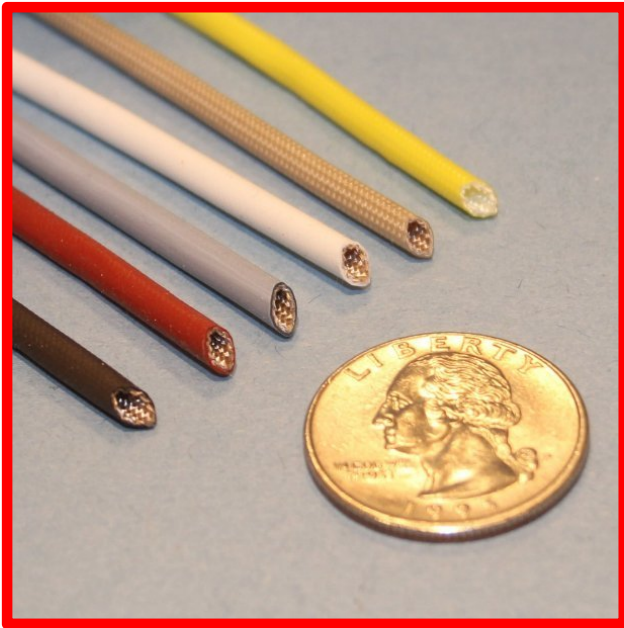

Designed as a primary insulation sleeve for protecting small diameter wire. Recognized by UL and CSA for 155°C, 600 volt service, and complies with VW-1 flammability requirements. Conforms to, and is listed on the QPL for MIL-I-3190/9. Available in 3 grades: NEMA Grade A-1, B-1 and C-1.

Extremely flexible and easily installed. Used in electrical apparatus such as electric motors, transformers, generators, home appliances, lighting fixtures, instrument circuits and controls, switchgear, breaker panels, welding equipment.

The inner braid is very fine and tightly woven, and along with the acrylic coating, this is a tough and flexible sleeve for wire protection.

Available in all standard AWG wire sizes (see end of this section for dimensions and tolerances).

Available in 10 Colors

Property

Procedure

Performance

Physical

Tensile Strength, Coating
 Ultimate Elongation, Coating
 Tear Strength, Coating
 Flexibility & Toughness, Coating

ASTM-D412
 ASTM-D412
 ASTM-D624
 UL 1441

850 psi
 150% @ 20°C
 60 psi
 Passes Penetration Test

Chemical

Oil & Solvent* Resistance
 Resistance to Acids and Alkalis
 Corrosion Resistance

MIL-I-3190/9
 -

Passes (good)
 Good
 Good. Contains no chlorine or other materials contributing to electrolyte formation

Compatibility

UL 1446

Good. Compatible with modified polyester, acrylic, epoxy, phenolic and formvar wire enamels.

Electrical

Dielectric Strength: after 48/23/50

Grade A
 Grade B
 Grade C-1
 Grade C-2
 Grade C-3

NEMA TF-1
 NEMA TF-1
 NEMA TF-1
 NEMA TF-1
 NEMA TF-1

7000V min avg., 5000v min individual
 4000v min. Avg., 2500v min. Individ.
 2500v min. Avg., 1500v min.indiv.
 1500v min. Avg., 800v min.indiv.
 no voltage guarantee

after 96/23/96, Grade A

NEMA TF-1

50% of Original Value

Hydrolytic Stability after 336 hrs
 @ 70°C over Constant Water Reflex

MIL-I-3190/9

1500 volts min. avg

Thermal

Thermal Endurance
 Brittleness Temperature
 Flame Resistance

MIL-I-3190/9 & UL 1441
 ASTM-D350
 UL 1441
 ASTM-D350, Method B
 NEMA TF-1
 MIL-I-3190/9, Method B

Class 155°C (F)
 -25°C
 Passes (VW-1), Grade C3 only
 Passes
 Passes
 Passes

Pushback

MIL-I-3190/9

No cracks or ruptures, 6000V min avg
 breakdown strength

Resistance to potting temperature

MIL-I-3190/3

No blisters, flow or cracks visible after 15 min @ 225C

This product is not usually stock, it is made to order: Delivery is approximately 10 business days.

Acrylic Coated Fiberglass Sleeve - Flexible - AWG Small Diameter
311°F / 155°C: High Temperature, Heat & Flame Resistant – UL & CSA Recognized
Available meeting NEMA Grade F-A-1, F-B-1, F-C-1, F-C-2 & F-C-3
Primary Insulation Coated Fiberglass Sleeve for
Wire Protection, NEMA Grade A-1/B-1/C-1/C-2/C-3 classified

High Temperature - Small Diameter – Acrylic Coated Fiberglass Sleeve with UL/CSA rating and NEMA Grade F-A-1 / F-B-1 / F-C-1 – F-C-2 – F-C-3 Classification										
Part Number	Nominal ID				Feet per Spool	Price per 100 feet				
	AWG / Inches / mm / -dash					F-A-1	F-B-1	F-C-1	F-C-2	F-C-3
S-FG-ACR-AWG24-X-Y	24	0.022	0.56		500*	\$ 49.60	45.52	39.27	34.60	28.22
S-FG-ACR-AWG22-X-Y	22	0.027	0.69		500*	\$ 50.75	46.87	43.00	35.65	29.87
S-FG-ACR-AWG20-X-Y	20	0.034	0.86		500*	\$ 54.27	47.72	43.35	36.20	30.67
S-FG-ACR-AWG19-X-Y	19	0.038	0.96		500*	\$ 54.51	48.69	44.12	37.35	30.97
S-FG-ACR-AWG18-X-Y	18	0.042	1.07		500*	\$ 54.87	49.60	44.62	38.39	31.37
S-FG-ACR-AWG17-X-Y	17	0.047	1.19		500*	\$ 55.07	50.40	44.97	39.44	31.97
S-FG-ACR-AWG16-X-Y	16	0.053	1.35		500*	\$ 55.92	50.75	45.52	40.00	32.65
S-FG-ACR-AWG15-X-Y	15	0.059	1.50		500*	\$ 57.60	53.67	46.87	40.80	33.45
S-FG-ACR-AWG14-X-Y	14	0.066	1.68	-01	500*	\$ 57.85	54.27	47.10	43.00	34.12
S-FG-ACR-AWG13-X-Y	13	0.076	1.93		250*	\$ 64.12	56.47	50.40	44.12	34.60
S-FG-ACR-AWG12-X-Y	12	0.085	2.16		250*	\$ 65.52	57.85	50.75	45.17	34.80
S-FG-ACR-AWG11-X-Y	11	0.095	2.41		250*	\$ 67.45	62.72	55.07	47.10	38.90
S-FG-ACR-AWG10-X-Y	10	0.106	2.69		250*	\$ 74.50	65.80	57.60	50.40	40.00
S-FG-ACR-AWG9-X-Y	9	0.118	3.10		250*	\$ 77.85	67.70	58.10	53.67	43.00
S-FG-ACR-AWG8-X-Y	8	0.133	3.38	-02	250*	\$ 83.05	74.50	64.42	56.47	45.52
S-FG-ACR-AWG7-X-Y	7	0.148	3.76		250*	\$ 87.20	78.12	67.70	58.10	46.87
S-FG-ACR-AWG6-X-Y	6	0.166	4.22		150*	\$ 95.37	83.55	72.37	64.12	50.40
S-FG-ACR-AWG5-X-Y	5	0.186	4.72	-03	150*	\$ 105.27	92.90	78.37	74.50	58.10
S-FG-ACR-AWG4-X-Y	4	0.208	5.28		150*	\$ 126.60	111.52	93.75	82.80	65.52
S-FG-ACR-AWG3-X-Y	3	0.234	5.94		150*	\$ 141.35	121.97	103.92	91.25	73.17
S-FG-ACR-AWG2-X-Y	2	0.263	6.68	-04	150*	\$ 159.20	138.72	118.37	104.97	83.55
S-FG-ACR-AWG1-X-Y	1	0.294	7.47		150*	\$ 181.72	157.85	132.90	119.47	95.67
S-FG-ACR-05-X-Y	5/16	0.313	7.95	-05	150*	\$ 205.57	179.27	153.22	133.45	106.90
S-FG-ACR-AWG0-X-Y	0	0.330	8.38		150	\$ 213.22	185.52	158.05	139.52	111.82
S-FG-ACR-06-X-Y	3/8	0.375	9.52	-06	150	\$ 296.72	260.32	225.00	191.00	152.15
S-FG-ACR-07-X-Y	7/16	0.438	11.12	-07	100	\$ 392.45	343.90	296.72	254.87	204.17
S-FG-ACR-08-X-Y	1/2	0.500	12.70	-08	100	\$ 455.42	421.12	388.25	331.25	265.02
S-FG-ACR-10-X-Y	5/8	0.625	15.87	-10	100	\$ 560.40	526.95	491.05	417.85	334.60
S-FG-ACR-12-X-Y	3/4	0.750	19.05	-12	100	\$ 674.65	639.87	597.12	545.07	436.82
S-FG-ACR-14-X-Y	7/8	0.875	22.22	-14	100	\$ 824.30	779.02	735.25	665.90	534.05
S-FG-ACR-16-X-Y	1	1.000	25.40	-16	100	\$ 1010.15	955.52	886.20	804.87	645.57
S-FG-ACR-18-X-Y	1 1/8	1.125	28.57	-18	100	\$ 1215.87	1147.92	1066.75	964.55	892.55
S-FG-ACR-20-X-Y	1 1/4	1.250	31.75	-20	100	\$ 1416.45	1334.55	1238.92	1120.25	1036.65
S-FG-ACR-22-X-Y	1 3/8	1.375	34.92	-22	3**	\$ 1559.75	1468.45	1362.20	1232.00	1141.30
S-FG-ACR-23-X-Y	1 7/16	1.437	36.49	-23	3**	\$ 1655.37	1557.55	1443.80	1307.67	1210.05
S-FG-ACR-24-X-Y	1 1/2	1.500	38.10	-24	3**	\$ 1704.97	1602.05	1487.20	1346.32	1244.35
S-FG-ACR-26-X-Y	1 5/8	1.625	41.27	-26	3**	\$ 1756.17	1651.80	1531.52	1386.05	1281.97
S-FG-ACR-28-X-Y	1 3/4	1.750	44.45	-28	3**	\$ 1822.02	1713.22	1281.97	1587.45	1436.45
S-FG-ACR-30-X-Y	1 7/8	1.875	47.62	-30	3**	\$ 2131.42	2004.25	1857.07	1681.65	1557.27
S-FG-ACR-32-X-Y	2	2.000	50.80	-32	3**	\$ 2508.47	2345.92	2176.30	1968.35	1821.67

For 1000 to 4999 feet -10% / For 5000 feet or more -17%

See end of section 1 for a table of pre-coated dimensional specifications for this product

For the "X" value in the part number, specify "S" for standard flexibility or "F" for enhanced flexibility.

For the "Y" value in the part number, specify color

This product is available in full coils only.

This product is not stock, it is made to order: Delivery is approximately 15 business days.

* Longer Spool Lengths Available. ** Minimum order 30 pieces

Braided Fiberglass Vehicle Truck Engine Exhaust Pipe Sleeve
1200°F / 648°C: Continuous Rating – Higher Temperature for Shorter Periods
BlackMax™ High Temperature & Heat Resistant

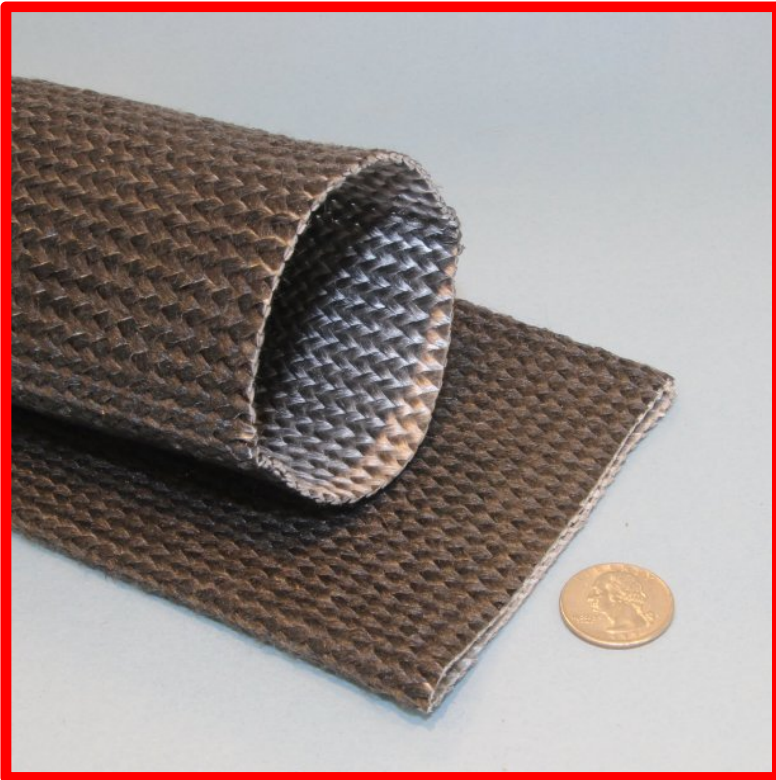

- 1/16" wall thickness
- Acrylic saturant added for enhanced ease of handling and anti-fray

Designed as a protection sleeve for truck & generator engine exhaust piping.

Easy to cut and maintains its end shape for ease of installation. Easily secured with stainless clamps.

Black color hides dirt and grime contamination.

Protects Personnel from incidental contact burns.

Helps prevent fires due to spray from ruptured hydraulic or fuel supply lines contacting hot exhaust metal directly.

1200°F / 648°C continuous rating, high insulation value & excellent personnel protection

Very High-Temperature Braided Saturated Sleeve with Acrylic Saturant – Exhaust Pipe Protection Sleeve				
Part Number	Size			Price per foot
	in	mm	-dash	
S-FG-BM-EX-M102-64	4.000	102	-64	\$ 15.36
S-FG-BM-EX-M114-72	4.500	114	-72	\$ 17.65
S-FG-BM-EX-M127-80	5.000	127	-80	\$ 19.64

This Product is Available By The Foot



Braided Fiberglass Sleeve with Graphite Impregnation
1200°F / 648°C: Continuous Rating – Higher Temperature for Shorter Periods
DeltaGlass™: High Temperature & Heat Resistant



- 1/16” and 1/8” wall thickness
- Graphite Impregnation

Graphite adds lubrication to result in a very slippery sleeve but does not add electrical conductivity.

Resists molten splash and weld splatter as it cannot stick to the graphite.

1200°F / 648°C continuous rating, high insulation value & excellent personnel protection

Very High-Temperature Braided Sleeve with Graphite Coating						
Part Number	Size			Feet per Spool Thin wall / Thick wall	Price / foot Thin wall Graphite	Price / foot Thick wall Graphite
	in / mm / -dash					
S-FG-GC-M006-04-X	.250	6	-04	1400 / 700	\$ 2.32	\$ 4.56
S-FG-GC-M010-06-X	.375	10	-06	1400 / 600	\$ 2.60	\$ 5.08
S-FG-GC-M013-08-X	.500	13	-08	1000 / 330	\$ 3.76	\$ 8.60
S-FG-GC-M016-10-X	.625	16	-10	900 / 315	\$ 4.20	\$ 9.20
S-FG-GC-M019-12-X	.750	19	-12	750 / 300	\$ 4.80	\$ 9.36
S-FG-GC-M022-14-X	.875	22	-14	650 / 300	\$ 5.44	\$ 9.44
S-FG-GC-M025-16-X	1.000	25	-16	500 / 290	\$ 6.64	\$ 9.72
S-FG-GC-M032-20-X	1.250	32	-20	450 / 280	\$ 7.76	\$ 11.08
S-FG-GC-M038-24-X	1.500	38	-24	350 / 225	\$ 9.56	\$ 13.08
S-FG-GC-M041-26-X	1.625	41	-26	300 / 208	\$ 9.61	\$ 13.36
S-FG-GC-M044-28-X	1.750	44	-28	300 / 208	\$ 10.12	\$ 13.84
S-FG-GC-M051-32-X	2.000	51	-32	250 / 190	\$ 12.48	\$ 18.68
S-FG-GC-M057-36-X	2.250	57	-36	250 / 190	\$ 12.61	\$ 19.02
S-FG-GC-M064-40-X	2.500	64	-40	225 / 180	\$ 14.84	\$ 20.28
S-FG-GC-M070-44-X	2.750	70	-44	225 / 180	\$ 15.17	\$ 21.55
S-FG-GC-M076-48-X	3.000	76	-48	200 / 175	\$ 15.96	\$ 25.40
S-FG-GC-M083-52-X	3.250	83	-52	200 / 175	\$ 16.67	\$ 26.31
S-FG-GC-M089-56-X	3.500	89	-56	190 / 170	\$ 17.80	\$ 27.44
S-FG-GC-M095-60-X	3.750	95	-60	190 / 170	\$ 18.97	\$ 28.99
S-FG-GC-M102-64-X	4.000	102	-64	175 / 140	\$ 21.36	\$ 31.16
S-FG-GC-M114-72-X	4.500	114	-72	175 / 140	\$ 27.65	\$ 40.73
S-FG-GC-M127-80-X	5.000	127	-80	120 / 100	\$ 35.64	\$ 52.44

For the “X” value, use “1” to specify Thin Wall; use “2” to specify Thick Wall

Thin Wall = 1/16” / 1.59mm • Thick Wall = 1/8” / 3.18mm

This Product is Available By The Foot

Basalt Fiber Knitted Conformable Engine Exhaust Pipe Insulation Sleeve

1382°F / 750°C: ExhaustSock™



High Temperature & Heat Resistant Sleeve



- Helps maintain exhaust gas temperatures in order to meet regulatory requirements.
- Knitted design allows for high conformability.
- Can be fabricated with apertures to accommodate brackets and mounting pads.
- Available in pre-cut or continuous lengths.
- Expandable and durable – provides ease of installation.
- Conforms to bends, elbows, flex sections and flanges.
- Suitable for Fixed Generators, Marine Engines and Generators, Automotive, Truck, Bus, Construction and Mining equipment.

Parameter	Test Method	Result
Thermal conductivity		0.031-0.038 W/mK
Thermal Endurance	BH 100-521	Pass - No degradation
Cold/Wet Endurance	BH 100-522	Pass - No degradation
Thermal Containment	BH 100-509	(See table below)
Flammability	SAE J369 /	No ignition
Flammability	D45133 Type A	No ignition
Flammability with Oil Contamination	BH 100-524 (ref. SAE J369)	Self-extinguishing
Vibration	ASTM D4728	Pass - No degradation
Fluid Resistance (bullet list below)	BH100-003F	No degradation or loss of flexibility

<ul style="list-style-type: none"> • 50/50 Antifreeze/Distilled Water • Transmission Fluid • ASTM Reference Fuel C • Brake Fluid SAE RM-66 • Windshield Washer Fluid 	<ul style="list-style-type: none"> • 5% NaCl • Diesel Fluid LSRD-4 • SAE 5W30 • Power Steering Fluid • Salt Spray ASTM G85 Pass
---	--

Thermal Containment Test per BH100-509 on ExhaustSock™ Sleeve

3.5" (89mm) Exhaust Pipe Parameters

Inlet Gas	828°C	Thermal Containment	251°C
Inlet Pipe Surface	534°C	Temperature at 20mm from sleeve (ambient)	121°C
Pipe	552°C	Temperature at 30mm from sleeve (ambient)	100°C
Sleeve	301°C	Temperature at 100mm from sleeve (ambient)	81°C

Very High-Temperature Knitted Rock Fiber Sleeve For Exhaust Pipe Protection						
Part Number	ID Size			Feet per Box	Price per Box	Cut Length Price per foot
	in	mm	-dash			
S-BRF-KNIT-1.00-M025-16	1.00	25	-16	500	\$ 3570.00	\$ 14.28
S-BRF-KNIT-1.50-M038-24	1.50	38	-24	300	\$ 2262.00	\$ 15.08
S-BRF-KNIT-2.00-M051-32	2.00	51	-32	250	\$ 2725.00	\$ 21.80
S-BRF-KNIT-2.50-M064-40	2.50	64	-40	225	\$ 2765.25	\$ 24.58
S-BRF-KNIT-3.00-M076-48	3.00	76	-48	200	\$ 2904.00	\$ 29.04
S-BRF-KNIT-3.50-M089-56	3.50	89	-56	175	\$ 2710.75	\$ 30.98
S-BRF-KNIT-4.00-M102-64	4.00	102	-64	164	\$ 2884.76	\$ 35.18
S-BRF-KNIT-5.00-M127-80	5.00	127	-80	125	\$ 2792.50	\$ 44.68

MINIMUM ORDER IS \$600.00

Braided Carbon Fiber Sleeve

1000°F / 537°C: Continuous Rating – Higher Temperature for Shorter Periods

High Temperature & Heat Resistant



Available in 0.013", 0.020" and 0.030" wall thickness.

Used to fabricate tubular structures that are lightweight and strong.

The cut ends will fray – standard anti-fray techniques can be used such as metal wire or clamps.

FlameShield™ High Temperature & Heat Resistant Carbon Fiber Sleeve					
Part Number	Nominal ID	Size Range	Spool Length in feet Bulk / Small	Price per Spool Bulk Spool / Small Spool	
Light Wall 0.013" replace "X" in part number with "LW"					
S-CF-M006-04-X	1/4" / 6 mm	1/8" to 5/16"	500 / 100	\$ 635.00 / \$ 168.00	
S-CF-M013-08-X	1/2" / 13 mm	1/4" to 5/8"	250 / 50	\$ 631.25 / \$ 168.00	
S-CF-M019-12-X	3/4" / 19 mm	5/16" to 7/8"	250 / 50	\$ 1,016.25 / \$ 258.00	
S-CF-M025-16-X	1" / 25 mm	3/8" to 1 1/16"	200 / 50	\$ 1,016.50 / \$ 321.00	
S-CF-M032-20-X	1 1/4" / 32 mm	1/2" to 1 1/2"	125 / 25	\$ 763.13 / \$ 198.00	
S-CF-M038-24-X	1 1/2" / 38 mm	5/8" to 1 3/4"	100 / 25	\$ 762.25 / \$ 243.00	
S-CF-M051-32-X	2" / 51 mm	3/4" to 2 3/16"	100 / 25	\$ 915.50 / \$ 291.00	
Medium Wall 0.020" replace "X" in part number with "MW"					
S-CF-M013-08-X	1/2" / 13 mm	1/4" to 5/8"	250 / 50	\$ 739.37 / \$ 192.00	
S-CF-M019-12-X	3/4" / 19 mm	5/16" to 7/8"	250 / 50	\$ 1,110.63 / \$ 282.00	
S-CF-M025-16-X	1" / 25 mm	7/16" to 1 1/16"	200 / 50	\$ 1,184.50 / \$ 369.00	
S-CF-M032-20-X	1 1/4" / 32 mm	9/16" to 1 1/2"	125 / 25	\$ 925.94 / \$ 237.00	
S-CF-M038-24-X	1 1/2" / 38 mm	3/4" to 1 3/4"	100 / 25	\$ 888.25 / \$ 282.00	
S-CF-M051-32-X	2" / 51 mm	7/8" to 2 3/16"	100 / 25	\$ 1,109.25 / \$ 348.00	
S-CF-M064-40-X	2 1/2" / 64 mm	1 1/16" to 3"	100 / 25	\$ 1,332.50 / \$ 414.00	
Heavy Wall 0.030" replace "X" in part number with "HW"					
S-CF-M019-12-X	3/4" / 19 mm	3/8" to 7/8"	250 / 50	\$ 1,362.50 / \$ 342.00	
S-CF-M025-16-X	1" / 25 mm	1/2" to 1 1/16"	200 / 50	\$ 1,450.00 / \$ 450.00	
S-CF-M032-20-X	1 1/4" / 32 mm	11/16" to 1 1/2"	125 / 25	\$ 1,209.38 / \$ 306.00	
S-CF-M038-24-X	1 1/2" / 38 mm	13/16" to 1 3/4"	100 / 25	\$ 1,090.00 / \$ 342.00	
S-CF-M051-32-X	2" / 51 mm	1" to 2 3/16"	100 / 25	\$ 1,450.00 / \$ 450.00	
S-CF-M064-40-X	2 1/2" / 64 mm	1 1/4" to 3"	100 / 25	\$ 1,820.00 / \$ 561.00	
S-CF-M076-48-X	3" / 76 mm	1 1/2" to 3 1/2"	50 / 25	\$ 1,088.75 / \$ 669.00	

**For the "X" value:
use "B" for Bulk Spool size, use "S" for Small Spool size**

Braided Fiberglass Sleeve with Vermiculite Coating: Premium Grade.
1500°F / 815°C: Continuous Rating – Higher Temperature for Shorter Periods
FlameShield™ 1500 Very High Temperature & Heat Resistant Sleeve



Effective thermal protection for wires, cables and hoses.

FlameShield™ braided fiberglass sleeve with specialty coating of Vermiculite.

- Available in thin wall (1/16 in. / 1.6mm.) and thick wall (1/8 in. / 3.18mm.).
- 1500°F / 815°C continuous exposure with excursion to 2000°F / 1093°C.
- Vermiculite adds Fire resistance, Anti-Fray and improved abrasion resistance.
- Certified to meet the requirements of ASTM E 162, ASTM E 662 & SMP 800-C.

Braided Fiberglass Sleeve with Vermiculite Coating: Premium Grade. (Continued)
1500°F / 815°C: Continuous Rating – Higher Temperature for Shorter Periods
FlameShield™ 1500 Very High Temperature & Heat Resistant Sleeve



1500°F / 815°C continuous rating, high insulation value & excellent personnel protection

The Vermiculite coating adds abrasion resistance and higher temperature capabilities which makes this sleeve a good insulator for hose, cable and copper or aluminum tubing. Meets Federal Railroad Administration requirements for surface flammability and rate of smoke generation.

FlameShield™ Very High Temperature & Heat Resistant Braided Vermiculite Coated Fiberglass Sleeve: Premium Grade						
Part Number	Size in / mm / -dash			Feet – Metres per Spool Thin wall / Thick wall	Price per foot / metre Thin wall 1/16"	Price per foot / metre Thick wall 1/8"
S-FG-VC-M006-04-X	.250	6	-04	1400 - 426 / 700 - 213	\$ 0.84 / \$ 2.76	\$ 1.68 / \$ 5.51
S-FG-VC-M010-06-X	.375	10	-06	1400 - 426 / 600 - 182	\$ 0.96 / \$ 3.15	\$ 1.88 / \$ 6.17
S-FG-VC-M013-08-X	.500	13	-08	1000 - 304 / 330 - 100	\$ 1.40 / \$ 4.59	\$ 3.16 / \$ 10.37
S-FG-VC-M016-10-X	.625	16	-10	900 - 274 / 315 - 96	\$ 1.52 / \$ 4.98	\$ 3.40 / \$ 11.15
S-FG-VC-M019-12-X	.750	19	-12	750 - 228 / 300 - 91	\$ 1.76 / \$ 5.77	\$ 3.44 / \$ 11.29
S-FG-VC-M022-14-X	.875	22	-14	650 - 198 / 300 - 91	\$ 2.00 / \$ 6.56	\$ 3.48 / \$ 11.42
S-FG-VC-M025-16-X	1.000	25	-16	500 - 152 / 290 - 88	\$ 2.44 / \$ 8.01	\$ 3.56 / \$ 11.68
S-FG-VC-M032-20-X	1.250	32	-20	450 - 137 / 280 - 85	\$ 2.88 / \$ 9.45	\$ 4.08 / \$ 13.39
S-FG-VC-M038-24-X	1.500	38	-24	350 - 106 / 225 - 68	\$ 3.52 / \$ 11.55	\$ 4.80 / \$ 15.75
S-FG-VC-M041-26-X	1.625	41	-26	300 - 91 / 208 - 63	\$ 3.61 / \$ 11.84	\$ 4.86 / \$ 15.94
S-FG-VC-M044-28-X	1.750	44	-28	300 - 91 / 208 - 63	\$ 3.72 / \$ 12.20	\$ 5.08 / \$ 16.67
S-FG-VC-M051-32-X	2.000	51	-32	250 - 76 / 190 - 57	\$ 4.60 / \$ 15.09	\$ 6.88 / \$ 22.57
S-FG-VC-M057-36-X	2.250	57	-36	250 - 76 / 190 - 57	\$ 4.97 / \$ 16.31	\$ 7.04 / \$ 23.10
S-FG-VC-M064-40-X	2.500	64	-40	225 - 68 / 180 - 54	\$ 5.48 / \$ 17.98	\$ 7.48 / \$ 24.54
S-FG-VC-M070-44-X	2.750	70	-44	225 - 68 / 180 - 54	\$ 5.56 / \$ 18.24	\$ 7.88 / \$ 25.85
S-FG-VC-M076-48-X	3.000	76	-48	200 - 60 / 175 - 53	\$ 5.88 / \$ 19.29	\$ 9.40 / \$ 30.84
S-FG-VC-M083-52-X	3.250	83	-52	200 - 60 / 175 - 53	\$ 6.03 / \$ 19.78	\$ 9.65 / \$ 31.66
S-FG-VC-M089-56-X	3.500	89	-56	190 - 57 / 170 - 51	\$ 6.56 / \$ 21.52	\$ 10.08 / \$ 33.07
S-FG-VC-M095-60-X	3.750	95	-60	190 - 57 / 170 - 51	\$ 7.05 / \$ 23.13	\$ 10.88 / \$ 35.69
S-FG-VC-M102-64-X	4.000	102	-64	175 - 53 / 140 - 42	\$ 7.92 / \$ 25.98	\$ 11.48 / \$ 37.66
S-FG-VC-M114-72-X	4.500	114	-72	175 - 53 / 140 - 42	N/A	\$ 14.49 / \$ 47.54
S-FG-VC-M127-80-X	5.000	127	-80	120 - 36 / 100 - 30	N/A	\$ 19.32 / \$ 63.39

For the "X" value in the p/n: use "1" to specify Thin Wall; use "2" to specify Thick Wall

This Product is Available By-The-Foot.

Minimum Order for less than 1" ID is 20 feet. Minimum order for 1" ID and larger is 10 feet.

Braided Fiberglass High Bulk Texturized Sleeve with Vermiculite Coating: Premium Grade

1500°F / 815°C: Continuous Rating – Higher Temperature for Shorter Periods
FlameShield™ 1500 TEX High Temperature & Heat Resistant



- FlameShield™ Braided High Bulk Texturized Premium Sleeve.
- Highest Insulation Value Sleeve Available.
- Available in Thin Wall (1/16”) and Thick Wall (1/8”).
- Texturization provides high bulk & high thermal insulation value.
- Certified to meet the requirements of ASTM E 162, ASTM E 662 & SMP 800-C.
- Vermiculite adds fire resistance, anti-fray and improved abrasion resistance.

This braided sleeve is fabricated from high quality type E fiberglass that will not burn and will withstand continuous exposure to temperatures of 1200°F / 648°C.

This material resists most acids and alkalis and is unaffected by most bleaches and solvents. It is highly flexible and conformable. The base fiber is manufactured to the specifications of ASTM D-578, ASTM committee D13, and subcommittee D13.18.

Available Plain and Vermiculite Coated.

1500°F / 815°C continuous rating, high insulation value & excellent personnel protection

MaxSleeve™ High Bulk Texturized Braided Fiberglass Sleeve With Vermiculite Coating - Premium Grade

Part Number	Size inch / mm / -dash			Thin Wall		Thick Wall	
				Feet / Metres per spool	Price per Spool	Feet / Metres per spool	Price per Spool
S-FG-TEXVC-M010-06-X	.375	10	-6	N/A	N/A	250 / 76	\$ 1217.50
S-FG-TEXVC-M013-08-X	.500	13	-8	500 / 152	\$ 1740.00	250 / 76	\$ 1287.50
S-FG-TEXVC-M016-10-X	.625	16	-10	N/A	N/A	100 / 30	\$ 695.00
S-FG-TEXVC-M019-12-X	.750	19	-12	250 / 76	\$ 1087.50	100 / 30	\$ 740.00
S-FG-TEXVC-M025-16-X	1.000	25	-16	250 / 76	\$ 1175.00	100 / 30	\$ 785.00
S-FG-TEXVC-M032-20-X	1.250	32	-20	N/A	N/A	100 / 30	\$ 830.00
S-FG-TEXVC-M038-24-X	1.500	38	-24	250 / 76	\$ 1287.50	100 / 30	\$ 875.00
S-FG-TEXVC-M051-32-X	2.000	51	-32	N/A	N/A	100 / 30	\$ 943.00

For the “X” value in the part number:
use “1” to specify Thin Wall; use “2” to specify Thick Wall

Thin Wall = 1/16” / 1.59mm • Thick Wall = 1/8” / 3.18mm

Weld Splatter Protection Sleeve with Velcro® Hook & Loop Closure Scuff-Sleeve™ VC Weld Shield



- Specialty protection for hoses, wire and cables.
- Sleeve with Velcro for easy retrofit.

FG/WeldShield sleeve is fiberglass base material with a neoprene rubber coating. Temperature range -60°F to +500°F with weld splatter protection. Very good UV protection.

FG/Carbon Fiber sleeve is fabricated with a fiberglass core and carbon fiber felt. Excellent for weld protection, hot tar, foundry and turbo exhaust. Temperature range -60°F to +1800F. Metal thread and fastener construction. Excellent UV protection.

Sold in 25 foot increments up to 150 feet continuous rolls, except FG/CarbonFiber which has a 50 foot maximum roll length. Available in standard sizes; larger or custom sizes can be easily fabricated if required. Helps to organize and bundle hoses and cables.

Scuff-Sleeve™ VC: Weld Splatter Specialty Protection Sleeve					
Part Number	Size inch / mm / -dash			Price per Foot	
				FG/WeldShield A	FG/CarbonFiber B
*S-WPS-VCL-M025-16-X	1.00	25	-16	\$ 10.20	\$ 19.20
*S-WPS-VCL-M038-24-X	1.50	38	-24	\$ 13.36	N/A
S-WPS-VCL-M051-32-X	2.00	51	-32	\$ 13.52	\$ 24.20
S-WPS-VCL-M060-38-X	2.38	60	-38	\$ 14.80	N/A
S-WPS-VCL-M064-40-X	2.50	64	-40	N/A	N/A
S-WPS-VCL-M070-44-X	2.75	70	-44	\$ 16.12	N/A
S-WPS-VCL-M076-48-X	3.00	76	-48	\$ 16.56	\$ 29.16
S-WPS-VCL-M083-52-X	3.25	83	-52	\$ 18.76	N/A
S-WPS-VCL-M089-56-X	3.50	89	-56	\$ 19.66	N/A
S-WPS-VCL-M102-64-X	4.00	102	-64	\$ 19.83	\$ 30.97
S-WPS-VCL-M114-72-X	4.50	114	-72	\$ 26.28	\$ 32.43
S-WPS-VCL-M127-80-X	5.00	127	-80	\$ 27.74	\$ 34.12
S-WPS-VCL-M152-96-X	6.00	152	-96	\$ 28.31	\$ 35.76
S-WPS-VCL-M178-112-X	7.00	165	-104	\$ 34.44	\$ 46.20
S-WPS-VCL-M203-128-X	8.00	203	-128	\$ 35.87	\$ 54.33
S-WPS-VCL-M305-192-X	12.00	305	-192	\$ 55.63	N/A

For the "X" value in the part number:
specify "A" for FG/WeldShield and "B" for FG/CarbonFiber

Width of the Velcro is 1.5" except part numbers indicated with (*) which is .75".

Braided Silica Sleeve - Hose, Cable, Wire, Pipe & Tube Protection
1800°F / 982°C: Continuous Rating – Higher Temperature for Shorter Periods
InSilMax™ Extreme High Temperature; Heat, Flame, Molten Metal & Weld Splatter Resistant



- An alternative to asbestos and ceramic based textiles.
- Highly flexible and minimal shrinkage.
- High abrasion resistance and tensile strength.
- Melts above 3000°F / 1648°C.
- Produced from an extremely pure base fiber (SiO₂) and can be used at 1800°F / 982°C continuously with short excursions to 3000°F / 1650°C.
- 1/16" (.0625") / 1.6mm nominal wall thickness (sizes below 3/4" ID have an approximate .04"/1mm nominal wall thickness).
- Silica based materials provide burn-through protection from molten metal, weld splatter and grinding sparks.

1800°F / 982°C continuous rating, high insulation value & excellent personnel protection

InSilMax™ Extreme Temperature Heat & Flame Resistant Braided Silica Sleeve					
Part Number	ID Size in / mm / -dash			Standard Lengths feet / metre	Price per Foot/Metre
S-S-M006-04-X	.250	6	-04	25 - 50 - 100 ft / 7.6 - 15 - 30 m	\$ 2.05 / \$ 6.72
S-S-M010-06-X	.375	10	-06	25 - 50 - 100 ft / 7.6 - 15 - 30 m	\$ 2.13 / \$ 6.98
S-S-M013-08-X	.500	13	-08	25 - 50 - 100 ft / 7.6 - 15 - 30 m	\$ 2.82 / \$ 9.25
S-S-M016-10-X	.625	16	-10	25 - 50 - 100 ft / 7.6 - 15 - 30 m	\$ 3.12 / \$ 10.23
S-S-M019-12-X	.750	19	-12	25 - 50 - 100 ft / 7.6 - 15 - 30 m	\$ 3.74 / \$ 12.27
S-S-M022-14-X	.875	22	-14	25 - 50 - 100 ft / 7.6 - 15 - 30 m	\$ 4.18 / \$ 13.71
S-S-M025-16-X	1.000	25	-16	25 - 50 - 100 ft / 7.6 - 15 - 30 m	\$ 5.32 / \$ 17.45
S-S-M032-20-X	1.250	32	-20	25 - 50 - 100 ft / 7.6 - 15 - 30 m	\$ 6.44 / \$ 21.12
S-S-M038-24-X	1.500	38	-24	25 - 50 - 100 ft / 7.6 - 15 - 30 m	\$ 7.55 / \$ 24.76
S-S-M044-28-X	1.750	44	-28	25 - 50 - 100 ft / 7.6 - 15 - 30 m	\$ 8.76 / \$ 28.73
S-S-M051-32-X	2.000	51	-32	25 - 50 - 100 ft / 7.6 - 15 - 30 m	\$ 10.52 / \$ 34.51
S-S-M064-40-X	2.500	64	-40	25 - 50 - 100 ft / 7.6 - 15 - 30 m	\$ 12.62 / \$ 41.39
S-S-M070-44-X	2.750	70	-44	10 - 25 - 50 ft / 3 - 7.6 - 15 m	\$ 16.21 / \$ 53.17
S-S-M076-48-X	3.000	76	-48	10 - 25 - 50 ft / 3 - 7.6 - 15 m	\$ 16.38 / \$ 53.73
S-S-M083-52-X	3.250	83	-52	10 - 25 - 50 ft / 3 - 7.6 - 15 m	\$ 16.60 / \$ 54.45
S-S-M089-56-X	3.500	89	-56	10 - 25 - 50 ft / 3 - 7.6 - 15 m	\$ 16.78 / \$ 55.04
S-S-M095-60-X	3.750	95	-60	10 - 25 - 50 ft / 3 - 7.6 - 15 m	\$ 17.23 / \$ 56.51
S-S-M102-64-X	4.000	102	-64	10 - 25 - 50 ft / 3 - 7.6 - 15 m	\$ 17.83 / \$ 58.48
S-S-M114-72-X	4.500	114	-72	10 - 25 - 50 ft / 3 - 7.6 - 15 m	\$ 18.66 / \$ 61.20

For the "X" value, insert length in feet

Other shorter or longer lengths may be available - please enquire

For sizes smaller than 1"/25mm ID – long lengths up to 300 feet may be available

Braided Silica Sleeve – Heavy Wall - Hose, Cable & Wire Protection
1800°F / 982°C: Continuous Rating – Higher Temperature for Shorter Periods
InSilMax™ +PL Extreme High Temperature; Heat, Flame, Molten Metal & Weld Splatter Resistant

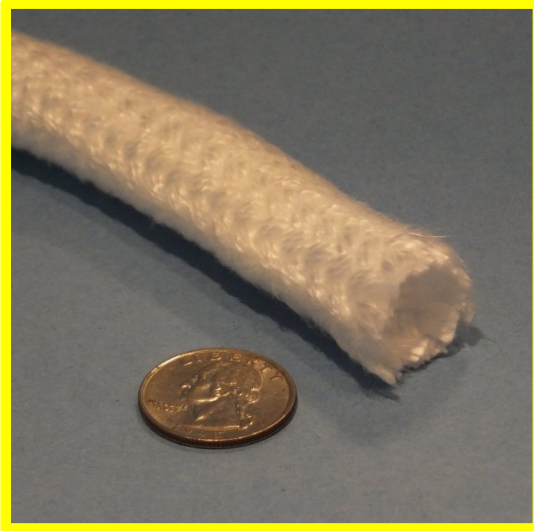

- Superior Insulation and Flame Resistance due to heavy wall construction.
- An alternative to asbestos and ceramic based textiles.
- Highly flexible and minimal shrinkage.
- High abrasion resistance and tensile strength.
- Melts above 3000°F / 1648°C.
- Produced from an extremely pure base fiber (SiO₂) and can be used at 1800°F / 982°C continuously with short excursions to 3000°F / 1650°C.
- 3mm (.118”) / wall thickness. Heaviest wall thickness available in this product line.
- Silica based materials provide burn-through protection from molten metal, weld splatter and grinding sparks.

1800°F / 982°C continuous rating, high insulation value & excellent personnel protection

InSilMax™ +PL Extreme Temperature Heat & Flame Resistant Silica Sleeve – Heavy Wall						
Part Number	ID Size in / mm / -dash			Spool Length feet / metre	Price per Spool	Price per Foot / minimum
S-S-HD-M006-04-X	.250	6	-04	164 / 50	\$ 992.20	\$ 6.05
S-S-HD-M010-06-X	.375	10	-06	164 / 50	\$ 1,047.96	\$ 6.39
S-S-HD-M013-08-X	.500	13	-08	164 / 50	\$ 1,387.44	\$ 8.46
S-S-HD-M016-10-X	.625	16	-10	164 / 50	\$ 1,535.04	\$ 9.36
S-S-HD-M019-12-X	.750	19	-12	164 / 50	\$ 1,810.56	\$ 11.04
S-S-HD-M022-14-X	.875	22	-14	164 / 50	\$ 2,053.28	\$ 12.52
S-S-HD-M025-16-X	1.000	25	-16	164 / 50	\$ 2,614.16	\$ 15.94
S-S-HD-M032-20-X	1.250	32	-20	164 / 50	\$ 3,027.44	\$ 18.46
S-S-HD-M038-24-X	1.500	38	-24	164 / 50	\$ 3,714.60	\$ 22.65
S-S-HD-M044-28-X	1.750	44	-28	164 / 50	\$ 4,305.00	\$ 26.25
S-S-HD-M051-32-X	2.000	51	-32	164 / 50	\$ 5,169.28	\$ 31.52
S-S-HD-M064-40-X	2.500	64	-40	164 / 50	\$ 6,192.64	\$ 37.76
S-S-HD-M070-44-X	2.750	70	-44	164 / 50	\$ 7,978.60	\$ 48.65
S-S-HD-M076-48-X	3.000	76	-48	164 / 50	\$ 8,406.64	\$ 51.26
S-S-HD-M083-52-X	3.250	83	-52	164 / 50	\$ 8,980.64	\$ 54.76
S-S-HD-M089-56-X	3.500	89	-56	164 / 50	\$ 9,382.44	\$ 57.21
S-S-HD-M095-60-X	3.750	95	-60	164 / 50	\$ 10,041.72	\$ 61.23
S-S-HD-M102-64-X	4.000	102	-64	164 / 50	\$ 10,883.04	\$ 66.36
S-S-HD-M114-72-X	4.500	114	-72	164 / 50	\$ 11,867.04	\$ 72.36

For the “X” value, use “S” for Full Spool, use “F” for By-The-Foot

This Product is available By-The-Foot – minimums may apply

Braided Silica Sleeve - XT/HD - Hose, Cable, Wire, Pipe & Tube Protection 1900°F / 1037°C: InSiMax™ XT



Extreme High Temperature; Heat, Flame, Molten Metal & Weld Splatter Resistant



- An alternative to asbestos and ceramic based textiles.
- Highly flexible and virtually no shrinkage.
- High abrasion resistance and tensile strength.
- Melts above 3000°F / 1648°C.
- Produced from an extremely pure base fiber (SiO₂) and can be used at 1900°F / 1037°C continuously with short excursions to 3000°F / 1650°C.
- 1/16" (.0625") / 1.6mm wall thickness (sizes below 3/4" ID have an approximate .04"/1mm nominal wall thickness).
- Silica based materials provide burn-through protection from molten metal, weld splatter, grinding sparks and direct flame exposure.

1900°F / 1037°C continuous rating, high insulation value & excellent personnel protection

InSiMax™ XT Extreme Temperature Heat & Flame Resistant Silica Sleeve

Part Number	Size			Standard Lengths feet / metre	Price per Foot/Metre
	in	mm	-dash		
S-S-XT-M006-04-X	.250	6	-04	25 - 50 - 100 ft / 7.6 - 15 - 30 m	\$ 4.10 / \$ 13.45
S-S-XT-M010-06-X	.375	10	-06	25 - 50 - 100 ft / 7.6 - 15 - 30 m	\$ 4.26 / \$ 13.97
S-S-XT-M013-08-X	.500	13	-08	25 - 50 - 100 ft / 7.6 - 15 - 30 m	\$ 5.64 / \$ 18.50
S-S-XT-M016-10-X	.625	16	-10	25 - 50 - 100 ft / 7.6 - 15 - 30 m	\$ 6.24 / \$ 20.47
S-S-XT-M019-12-X	.750	19	-12	25 - 50 - 100 ft / 7.6 - 15 - 30 m	\$ 7.48 / \$ 24.53
S-S-XT-M022-14-X	.875	22	-14	25 - 50 - 100 ft / 7.6 - 15 - 30 m	\$ 8.36 / \$ 27.42
S-S-XT-M025-16-X	1.000	25	-16	25 - 50 - 100 ft / 7.6 - 15 - 30 m	\$ 10.64 / \$ 34.90
S-S-XT-M032-20-X	1.250	32	-20	25 - 50 - 100 ft / 7.6 - 15 - 30 m	\$ 12.88 / \$ 42.25
S-S-XT-M038-24-X	1.500	38	-24	25 - 50 - 100 ft / 7.6 - 15 - 30 m	\$ 15.10 / \$ 49.53
S-S-XT-M044-28-X	1.750	44	-28	25 - 50 - 100 ft / 7.6 - 15 - 30 m	\$ 17.52 / \$ 57.47
S-S-XT-M051-32-X	2.000	51	-32	25 - 50 - 100 ft / 7.6 - 15 - 30 m	\$ 21.04 / \$ 69.01
S-S-XT-M064-40-X	2.500	64	-40	25 - 50 - 100 ft / 7.6 - 15 - 30 m	\$ 25.24 / \$ 82.79
S-S-XT-M070-44-X	2.750	70	-44	10 - 25 - 50 ft / 3 - 7.6 - 15 m	\$ 32.43 / \$ 106.37
S-S-XT-M076-48-X	3.000	76	-48	10 - 25 - 50 ft / 3 - 7.6 - 15 m	\$ 32.76 / \$ 107.45
S-S-XT-M083-52-X	3.250	83	-52	10 - 25 - 50 ft / 3 - 7.6 - 15 m	\$ 33.21 / \$ 108.93
S-S-XT-M089-56-X	3.500	89	-56	10 - 25 - 50 ft / 3 - 7.6 - 15 m	\$ 33.56 / \$ 110.07
S-S-XT-M095-60-X	3.750	95	-60	10 - 25 - 50 ft / 3 - 7.6 - 15 m	\$ 34.46 / \$ 113.03
S-S-XT-M102-64-X	4.000	102	-64	10 - 25 - 50 ft / 3 - 7.6 - 15 m	\$ 35.66 / \$ 116.96
S-S-XT-M114-72-X	4.500	114	-72	10 - 25 - 50 ft / 3 - 7.6 - 15 m	\$ 37.33 / \$ 122.44

For the "X" value, insert length in feet

Other shorter or longer lengths may be available - please enquire

Ceramic Fiber Braided Sleeve - Premium Grade
2000°F / 1093°C: CerMax™ High Temperature & Heat Resistant Sleeve



- Soft and pliable.
- Asbestos free.
- Cuts easily to length with scissors. This sleeve does not expand.

2000°F / 1093°C continuous rating, high insulation value

CerMax™ High Temperature & Heat Resistant Braided Ceramic Fiber Sleeve - Premium			
Part Number	Nominal ID	Spool Length Ft	Price per Spool
S-C-B-M003-02	1/8"	200	\$ 2620.43
S-C-B-M006-04	1/4"	200	\$ 5445.72
S-C-B-M010-06	3/8"	200	\$ 7030.68
S-C-B-M013-08	1/2"	100	\$ 5035.17
S-C-B-M019-12	3/4"	100	\$ 5537.50

This Product is NOT Available By-The-Foot – Spools Only

High Alumina Content Braided Sleeve 2300°F / 1260°C: AluMax™ High Temperature & Heat Resistant Sleeve



- Soft and pliable.
- Asbestos free.
- Cuts easily to length with scissors.
- This is a braided sleeve and has a small amount of expandibility.
- Highest temperature rated sleeve available.
- Fabricated from continuous filament fibers.
- Boron free.

2300°F / 1260°C continuous rating, high insulation value

AluMax™ High Temperature & Heat Resistant Braided Alumina Sleeve - Premium			
Part Number	Nominal ID inch / mm	Spool Length Ft / m	Price per Spool
S-ALUMINA-0.031-M00079	1/32" / 0.79	150 / 45	\$ 1046.25
S-ALUMINA-0.078-M00198	5/64" / 1.98	150 / 45	\$ 1113.75
S-ALUMINA-0.125-M00317	1/8" / 3.17	150 / 45	\$ 1612.50
S-ALUMINA-0.250-M00635	1/4" / 6.35	150 / 45	\$ 1852.50
S-ALUMINA-0.500-M0127	1/2" / 12.7	150 / 45	\$ 3622.50
S-ALUMINA-0.750-M01905	3/4" / 19.05	150 / 45	\$ 4908.75
S-ALUMINA-1.000-M02540	1" / 25.4	150 / 45	\$ 6105.00

This product is made to order - please allow 10 to 12 business days for production

This Product is NOT Available By-The-Foot

Spark Plug & Ignition Wire Boot Protection Sleeve
1200°F / 648°C: FlameShield™ High Temperature & Heat Resistant Sleeve



- Soft and pliable. Asbestos free.
- Easy to install - just slide over boot or plug.
- Requires no clearance to the header - direct contact will not deteriorate the sleeve.
- Wall thickness of .085". Diameter of .75" / 19mm
- Fits straight and angled boots.
- Available in 3 lengths: 4 1/2" (short), 7 1/2" (medium) and 12" (long).
- 4 Colors: White, Red, Blue, Black
- Short sleeves are available from stock in natural (White). Colors by special order
- Medium sleeves from stock are available in all colors.
- Long sleeves are available by special order.

1200°F / 648°C continuous rating, high insulation value

FlameShield™ High Temperature & Heat Resistant Sleeves for Ignition Boot and Spark Plug Protection		
Part Number	Case Price (144)	Price Each
4 1/2" / 115mm Length S-FG-SPB-S-M019-12-X	\$ 550.00	\$ 7.64
7 1/2" / 190mm Length S-FG-SPB-M-M019-12-X	\$ 612.00	\$ 8.50
12" / 305mm Length S-FG-SPB-L-M019-12-X	\$ 977.50	\$ 13.58

For the "X" value use BK - Black, BU - Blue, RD - Red and NT for Natural (White)



Aluminum Foil Coated Fiberglass Heat Reflective Split Sleeve with Adhesive Closure

454°F / 240°C DeltaGlass™ / PET Base Material blend - Aluminum Foil Coating



- Split Sleeve for easy installation on existing wires, cables or hoses.
- Supplied in 4 foot / 1.2 metre lengths.
- Fiberglass base sleeve with PET filament interleave. Aluminum foil coating, with an aluminum foil adhesive closure strip.
- Adhesive strip closure keeps out contaminants and liquids.
- Cuts cleanly.
- Protects wiring or hoses from radiant and convective heat.
- Excellent automotive under-hood protection of wiring and hoses from engine heat.
- .042" / 1.06mm wall thickness.
- The sleeve keeps its round shape due to the PET filament interweave.

DeltaGlass™ Heat Reflective Split Sleeve with Adhesive Closure				
Part Number	ID Size		# of sections minimum order	Price per 4 foot Section
	inch	mm		
S-FG-AL-SLIT-ACL-0.250-M006-04	1/4"	6	4	\$ 7.33
S-FG-AL-SLIT-ACL-0.375-M010-06	3/8"	10	3	\$ 12.16
S-FG-AL-SLIT-ACL-0.500-M013-08	1/2"	13	3	\$ 15.60
S-FG-AL-SLIT-ACL-0.625-M016-10	5/8"	16	2	\$ 18.53
S-FG-AL-SLIT-ACL-0.750-M019-12	3/4"	19	2	\$ 22.33
S-FG-AL-SLIT-ACL-1.000-M025-16	1"	25	2	\$ 26.30
S-FG-AL-SLIT-ACL-1.250-M032-20	1 1/4"	32	2	\$ 31.43
S-FG-AL-SLIT-ACL-1.500-M038-24	1 1/2"	38	2	\$ 36.40
S-FG-AL-SLIT-ACL-2.000-M051-32	2"	51	1	\$ 48.53

Not available By-The-Foot

This sleeve is non-expandable – please measure your application carefully.



Aluminized Heat Reflecting Fiberglass Sleeve - PET Film Coated 1200°F / 648°C DeltaGlass™ Base Material - 454°F / 240°C Film Coating



- Protection from intense radiant heat. Reflects more than 95% of the radiant heat that contacts its surface.
- Base fabric rated for continuous operation at 1200°F / 648°C.
- This sleeve is the perfect protection for cables and hoses when radiant heat from infrared sources such as super-hot metal slabs, proximity to liquid metal, open flame/plasma or engine exhaust manifolds and piping is a concern.
- Wall thickness .025" / .635mm.
- Sleeve is supplied collapsed flat on a spool.

This high temperature and radiant heat reflective sleeve is constructed from a high-temperature fine braid fiberglass sleeve, which is then coated with highly-reflective polished aluminum. The base fabric is designed for long term continuous operation at 1000°F / 537°C, this sleeve will withstand short duration exposure up to 1200°F / 650°C.

Added protection can be achieved by layering with other sleeve materials underneath the reflective layer.

FlameShield™ Aluminized PET Film Coated Fiberglass Radiant Heat Reflective Sleeve .025" / .635mm Wall Thickness				
Part Number	Inside Diameter inch / mm / dash#	Spool Length, feet Bulk / Small	Price per Spool Bulk Spool / Small Spool	Price per Foot
S-FG-ALM-0.50-M013-08-X	0.50 / 13 / -08	250 / 100	\$ 407.50 / \$ 179.00	\$ 4.48
S-FG-ALM-0.62-M016-10-X	0.62 / 16 / -10	250 / 100	\$ 607.50 / \$ 260.00	\$ 6.50
S-FG-ALM-0.75-M019-12-X	0.75 / 19 / -12	250 / 100	\$ 712.50 / \$ 302.00	\$ 7.55
S-FG-ALM-0.87-M022-14-X	0.87 / 22 / -14	250 / 100	\$ 822.50 / \$ 346.00	\$ 8.65
S-FG-ALM-1.00-M025-16-X	1.00 / 25 / -16	250 / 100	\$ 877.50 / \$ 368.00	\$ 9.20
S-FG-ALM-1.25-M032-20-X	1.25 / 32 / -20	250 / 100	\$ 1097.50 / \$ 456.00	\$ 11.40
S-FG-ALM-1.50-M038-24-X	1.50 / 38 / -24	250 / 100	\$ 1207.50 / \$ 499.00	\$ 12.48
S-FG-ALM-1.75-M044-28-X	1.75 / 44 / -28	100 / 50	\$ 637.00 / \$ 335.00	\$ 16.77
S-FG-ALM-2.00-M051-32-X	2.00 / 51 / -32	100 / 50	\$ 790.00 / \$ 412.00	\$ 20.60
S-FG-ALM-2.50-M064-40-X	2.50 / 64 / -40	100 / 50	\$ 1123.00 / \$ 578.50	\$ 28.92
S-FG-ALM-3.00-M076-48-X	3.00 / 64 / -48	100 / 50	\$ 1150.00 / \$ 591.66	\$ 29.58

For the "X" value:

use "B" for Bulk Spool size, use "S" for Small Spool size, use "F" for by-the-foot lengths

This Product is available in bulk spools, shop spools and By-The-Foot

Heat Reflecting Aluminum Foil Coated Fiberglass Sleeve
454°F / 240°C Convoluted High Bulk – with Aluminum Foil Coating
DeltaGlass™ / PET filament Blended Base Material



- Protection from intense radiant heat. Reflects more than 95% of the radiant heat that contacts its surface.
- Base yarn is a blend of e-fiberglass and PET filaments, rated for continuous operation at 454°F / 240°C. The PET interweave keeps the sleeve in its round form for easy wire/cable/hose insertion.
- This sleeve provides protection for cables and hoses when radiant heat from infrared sources such as super-hot metal slabs, proximity to liquid metal, open flame/plasma or engine exhaust manifolds is a concern.
- Wall thickness .045" / 1.14mm. Sleeve is supplied in a 4 foot length.

This high temperature and radiant heat reflective sleeve is constructed from a high-temperature fine braid fiberglass and PET filament interwoven base sleeve, which is then coated with highly-reflective polished aluminum foil. The base fabric is designed for long term continuous operation at 454°F / 240°C.

Added protection can be achieved by layering with other sleeve or tape materials underneath the reflective layer.

FlameShield™ Aluminum Foil Coated Fiberglass Radiant Heat Reflective Convoluted Sleeve .045" / 1.14mm Wall Thickness		
Part Number	Inside Diameter inch / mm / dash#	Price per 4 foot Section
S-FG-AL-CONVOL-0.375-M013-08	0.37 / 10 / -06	\$ 8.66
S-FG-AL-CONVOL-0.500-M013-08	0.50 / 13 / -08	\$ 11.50
S-FG-AL-CONVOL-0.620-M016-10	0.62 / 16 / -10	\$ 14.03
S-FG-AL-CONVOL-0.750-M019-12	0.75 / 19 / -12	\$ 15.40
S-FG-AL-CONVOL-0.875-M022-14	0.87 / 22 / -14	\$ 17.46
S-FG-AL-CONVOL-1.000-M025-16	1.00 / 25 / -16	\$ 19.17
S-FG-AL-CONVOL-1.250-M032-20	1.25 / 32 / -20	\$ 23.17

This Product is only available in 4 foot length sections

Aluminized Heat Reflecting Fiberglass Sleeve forming Tape/Wrap; with adhesive strip - PET Film Coated

1200°F / 648°C DeltaGlass™ Base Material - 454°F / 240°C Film Coating

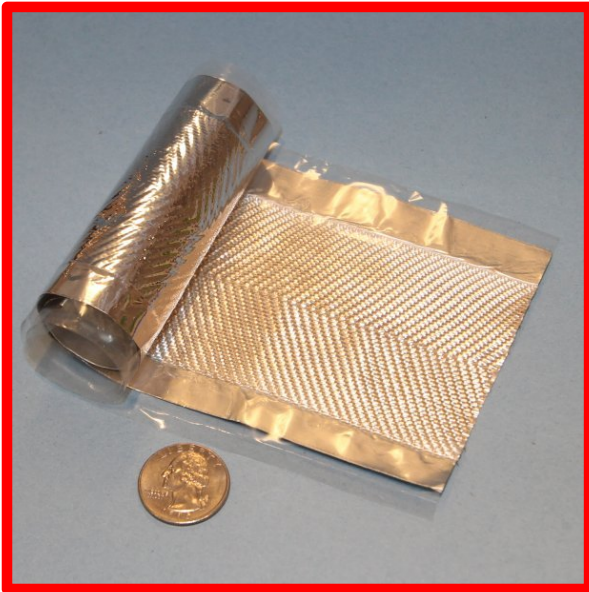

- Protection from intense radiant heat. Reflects more than 95% of the radiant heat that contacts its surface.
- Base fabric rated for continuous operation at 1200°F / 648°C. The adhesive withstands 425°F / 218°C.
- This tape wrap has a high temperature adhesive strip along its length, allowing the tape to be wrapped and formed into a sleeve around wires, cables or hoses, or wrapped spirally down the length.
- Provides protection for cables and hoses when radiant heat from infrared sources such as super-hot metal slabs, proximity to liquid metal, open flame/plasma or engine exhaust manifolds is a concern.
- Wall thickness .025”.

This high temperature and radiant heat reflective tape wrap is constructed from a high-temperature fine woven fiberglass fabric substrate, which is then coated with highly-reflective polished aluminum. The base fabric is designed for long term continuous operation at 1200°F / 648°C.

Added protection can be achieved by layering with other sleeve or tape materials underneath the reflective layer.

FlameShield™ Aluminized PET Film Coated Fiberglass Radiant Heat Reflective Tape Wrap for Sleeve Formation				
Part Number	Resulting Sleeve Maximum Inside Diameter inch / mm / dash#	Tape Width	Spool Length, feet Bulk / Small	Price per Foot Bulk Spool / Small Spool
S-FG-AL-TACL-0.500-M013-08-X	0.50 / 13 / -08	1.5"	250 / 100	\$ 690.00 / \$ 293.00
S-FG-AL-TACL-0.750-M019-12-X	0.75 / 19 / -12	2.25"	250 / 100	\$ 867.50 / \$ 363.00
S-FG-AL-TACL-1.000-M025-16-X	1.00 / 25 / -16	3.75"	200 / 100	\$ 1034.00 / \$ 534.00
S-FG-AL-TACL-1.250-M032-20-X	1.25 / 32 / -20	4.5"	200 / 100	\$ 1254.00 / \$ 644.00
S-FG-AL-TACL-1.500-M038-24-X	1.50 / 38 / -24	5.25"	200 / 100	\$ 1476.00 / \$ 755.00
S-FG-AL-TACL-1.750-M044-28-X	1.75 / 44 / -28	6"	100 / 50	\$ 883.00 / \$ 458.50
S-FG-AL-TACL-2.000-M051-32-X	2.00 / 51 / -32	6.5"	100 / 50	\$ 973.00 / \$ 503.50
S-FG-AL-TACL-2.250-M064-40-X	2.25 / 57 / -36	7.5"	100 / 50	\$ 1233.00 / \$ 633.50

For the “X” value: use “B” for Bulk Spool size, use “S” for Small Spool size



Radiant Heat Reflective Sleeve for Cable, Hose, Wire and Line Protection: Aluminum Foil Coated Fiberglass 1200°F / 648°C: FlameShield™: High Temperature & Radiant Heat Reflective Sleeve for Low Flex Static Applications



- Protection from intense radiant heat. Reflects more than 95% of the radiant heat that contacts its surface.
- The base fabric is rated for continuous operation at 1200°F / 648°C. The aluminum foil melts at 1220°F / 660°C. The aluminum is bonded to the fiberglass under pressure and with an adhesive that will smoke off at 425°F / 218°C - long term high temperature exposure may result in the aluminum foil being separated from the underlying fabric material.
- This sleeve provides optimum protection for cables and hoses when radiant heat from infrared sources such as super-hot metal slabs, proximity to liquid metal, open flame/plasma or engine exhaust manifolds is a concern.
- Heat reflecting layer is pure aluminum foil.
- This sleeve is designed for low flex or low movement and static applications. High flexing cycles will result in the foil cracking.
- Excellent under-hood protection for wiring and hoses.

This heat reflecting sleeve is constructed from a high-temperature base fabric which is then coated with highly-reflective polished aluminum foil. The aluminum coating melts at 1220°F / 660°C, however it does take some time for the aluminum to absorb enough heat to melt – thereby it can withstand short exposure to the higher temperatures.

The sleeve is fabricated from a roll of heat reflecting fabric, and is sewn with a double lock-stitch seam utilizing high-temperature fiberglass thread. The resulting sleeve has a teardrop or tadpole profile when viewed on-end; the width of the sewn tail is typically 5/8" or 16mm. A sleeve with Velcro closure is available, making the sleeve installable on cables and hoses without having to disconnect them. Added thermal protection can be achieved by layering with other sleeve materials underneath the reflective layer.

FlameShield™ Aluminum Foil Coated Fiberglass Radiant Heat Reflective Sewn Sleeve – Low Flex & Static Applications		
Part Number	Inside Diameter inch / mm / dash#	Price per Foot 21oz/yd ² / 35oz/yd ²
S-FG-ALF-SWN-0.500-M013-08-X	0.50 / 13 / -08	\$ 5.48 / \$ 6.58
S-FG-ALF-SWN-0.750-M019-12-X	0.75 / 19 / -12	\$ 7.17 / \$ 8.60
S-FG-ALF-SWN-1.000-M025-16-X	1.00 / 25 / -16	\$ 8.87 / \$10.64
S-FG-ALF-SWN-1.250-M032-20-X	1.25 / 32 / -20	\$ 10.48 / \$ 12.57
S-FG-ALF-SWN-1.500-M038-24-X	1.50 / 38 / -24	\$ 12.17 / \$ 14.60
S-FG-ALF-SWN-1.750-M044-28-X	1.75 / 44 / -28	\$ 13.87 / \$ 16.64
S-FG-ALF-SWN-2.000-M051-32-X	2.00 / 51 / -32	\$ 15.53 / \$ 18.63
S-FG-ALF-SWN-2.500-M064-40-X	2.50 / 64 / -40	\$ 18.97 / \$ 22.76
S-FG-ALF-SWN-3.000-M076-48-X	3.00 / 76 / -48	\$ 22.29 / \$ 26.75
S-FG-ALF-SWN-3.500-M089-56-X	3.50 / 89 / -56	\$ 25.68 / \$ 30.82
S-FG-ALF-SWN-4.000-M102-64-X	4.00 / 102 / -64	\$ 28.97 / \$ 34.76
Other sizes available – please enquire		

For the X value: specify "21" for construction from 21 oz/yd² fabric; specify "35" for construction from 35 oz/yd² fabric

Note: The aluminum adhesion on the 35oz fabric is not as high as on the 21oz fabric, and some perforation separation of the aluminum will occur due to folding or flexing of the material.

This Product is Available By-The-Foot; some minimums may apply

Aluminized PET Film Coated Fiberglass Radiant Heat Reflective Sewn Sleeve
1200°F / 648°C DeltaGlass™ Base Material - 454°F / 240°C Film Coating
High Temperature & Radiant Heat Reflective Sleeve for High Flex Applications



- Protection from intense radiant heat.
- Reflects more than 95% of the radiant heat that contacts its surface.
- Base fabric rated for continuous operation at 1200°F / 648°C.
- This sleeve provides optimum protection for cables and hoses when radiant heat from infrared sources such as super-hot metal slabs, proximity to liquid metal, open flame/plasma or engine exhaust manifolds is a concern.
- Heat reflecting layer is dual side aluminized film.
- This sleeve is designed for high flex or high movement applications.
- Highly popular for engine under-hood wiring & hose/tube protection

Constructed from a high-temperature base fabric which is then coated with dual side aluminized film. The base fabric is designed for long term continuous operation at 1000°F / 537°C, this sleeve will withstand short duration exposure up to 1200°F / 650°C. The aluminum film coating melts at 375°F.

The sleeve is fabricated from a roll fabric, and is sewn with a double lock-stitch seam utilizing high-temperature thread. The resulting sleeve has a teardrop or tadpole profile when viewed on-end; the width of the sewn tail is typically 5/8" or 16mm. A sleeve with Velcro closure is available, making the sleeve installable on cables and hoses without having to disconnect them. The Velcro sleeve results in a circular sleeve profile when closed. Added protection can be achieved by layering with other sleeve materials underneath the reflective layer.

FlameShield™ Aluminum Film Coated Fiberglass Radiant Heat Reflective Sewn Sleeve – High Flex Applications		
Part Number	Inside Diameter inch / mm / dash#	Price per Foot 8oz/yd² / 11oz/yd²
S-FG-ALM-SWN-M013-08-X	0.50 / 13 / -08	\$ 5.48 / \$ 6.58
S-FG-ALM-SWN-M019-12-X	0.75 / 19 / -12	\$ 7.17 / \$ 8.60
S-FG-ALM-SWN-M025-16-X	1.00 / 25 / -16	\$ 8.87 / \$10.64
S-FG-ALM-SWN-M032-20-X	1.25 / 32 / -20	\$ 10.48 / \$ 12.57
S-FG-ALM-SWN-M038-24-X	1.50 / 38 / -24	\$ 12.17 / \$ 14.60
S-FG-ALM-SWN-M044-28-X	1.75 / 44 / -28	\$ 13.87 / \$ 16.64
S-FG-ALM-SWN-M051-32-X	2.00 / 51 / -32	\$ 15.53 / \$ 18.63
S-FG-ALM-SWN-M064-40-X	2.50 / 64 / -40	\$ 18.97 / \$ 22.76
S-FG-ALM-SWN-M076-48-X	3.00 / 76 / -48	\$ 22.29 / \$ 26.75
S-FG-ALM-SWN-M089-56-X	3.50 / 89 / -56	\$ 25.68 / \$ 30.82
S-FG-ALM-SWN-M102-64-X	4.00 / 102 / -64	\$ 28.97 / \$ 34.76
Other sizes available – please enquire		

For the X value: specify "8" for construction from 8 oz/yd² fabric; specify "11" for construction from 11 oz/yd² fabric

This Product is Available By-The-Foot



Aluminum Foil Coated Fiberglass Heat Reflective Sleeve with VELCRO® Brand Hook & Loop Closure
1200°F / 648°C: Aluminum Foil Coated Fiberglass High Temperature & Radiant Heat Reflective, For Low Flex and Static Applications

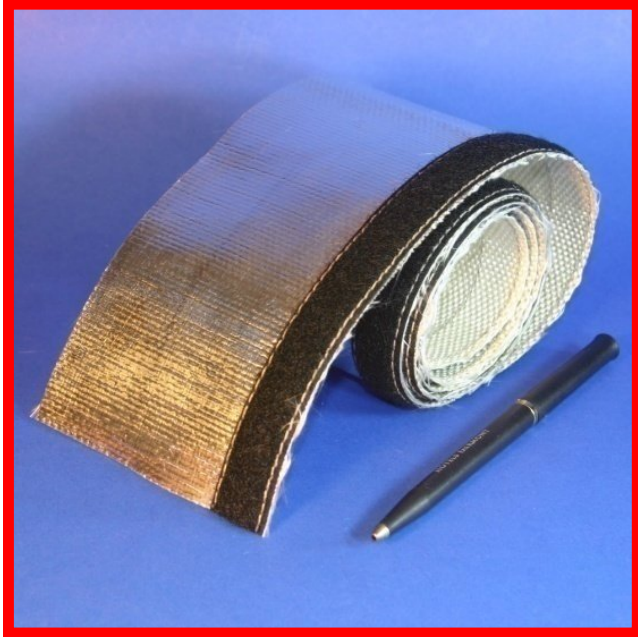

- Protection from intense radiant heat.
- Reflects more than 95% of the radiant heat that contacts its surface.
- Base fabric is rated for continuous operation at 1200°F / 648°C.
- This sleeve is the perfect protection for cables and hoses when radiant heat from infrared sources such as super-hot metal slabs, proximity to liquid metal, open flame/plasma or engine exhaust manifolds is a concern.
- VELCRO® Brand hook & loop closure allows the sleeve to be installed and removed from wire, cable, hose and pipe without disconnection.
- Designed for low flex and static applications.

Constructed from a high-temperature base fabric which is then laminated coated with highly-reflective polished aluminum. Designed for long term continuous operation at 650°F / 343°C, this sleeve will withstand short duration exposure up to 1200°F / 650°C. The aluminum coating melts at 1220°F / 660°C, however it does take some time for the aluminum to absorb enough heat to melt – thereby it can withstand short exposure to the higher temperatures.

The sleeve is fabricated from a roll fabric, and is then sewn with VELCRO® Brand hook and loop, allowing this sleeve to be installed and removed with disconnection of wiring, cables, hose and pipe. Sewing is performed with high temperature thread. Added protection can be achieved by layering with other sleeve materials underneath the reflective layer.

The same base fabric can be used for constructing a wide variety of protective sleeves and covers.

Aluminum Foil Coated Fiberglass Radiant Heat Protection Sleeve with VELCRO® Brand Hook & Loop		
Part Number	Inside Diameter inch / mm / dash#	Price / Foot 21oz/yd ² / 35oz/yd ²
S-FG-ALF-VCL-M019-12-X	0.75 / 19 / -12	\$ 11.17 / \$ 13.40
S-FG-ALF-VCL-M025-16-X	1.00 / 25 / -16	\$ 12.87 / \$ 15.44
S-FG-ALF-VCL-M032-20-X	1.25 / 32 / -20	\$ 14.48 / \$ 17.37
S-FG-ALF-VCL-M038-24-X	1.50 / 38 / -24	\$ 16.17 / \$ 19.40
S-FG-ALF-VCL-M044-28-X	1.75 / 44 / -28	\$ 17.87 / \$ 21.44
S-FG-ALF-VCL-M051-32-X	2.00 / 51 / -32	\$ 19.53 / \$ 23.44
S-FG-ALF-VCL-M064-40-X	2.50 / 64 / -40	\$ 22.97 / \$ 27.56
S-FG-ALF-VCL-M076-48-X	3.00 / 76 / -48	\$ 26.29 / \$ 31.55
S-FG-ALF-VCL-M089-56-X	3.50 / 89 / -56	\$ 29.68 / \$ 35.62
S-FG-ALF-VCL-M102-64-X	4.00 / 102 / -64	\$ 32.97 / \$ 39.56
Other sizes available – please enquire		

For the X value: specify "21" for construction from 21 oz/yd² fabric; specify "35" for construction from 35 oz/yd² fabric

This Product is Available By-The-Foot



Heat Reflective Aluminized PET Coated Fiberglass Sleeve with VELCRO® Brand Hook & Loop Closure
 1200°F / 648°C DeltaGlass™ Base Material - 454°F / 240°C Film Coating
 High Temperature & Radiant Heat Reflective For High Flex and High Movement Applications



- Protection from intense radiant heat.
- Reflects more than 95% of the radiant heat that contacts its surface.
- Base fabric is rated for continuous operation at 1000°F / 537°C.
- This sleeve is the perfect protection for cables and hoses when radiant heat from infrared sources such as super-hot metal slabs, proximity to liquid metal, open flame/plasma or engine exhaust manifolds is a concern.
- Velcro closure allows the sleeve to be installed and removed from wire, cable, hose and pipe without disconnection.
- Designed for high flex and movement applications.

Constructed from a high-temperature base fabric which is then laminated coated with dual side aluminized film. Designed for long term continuous operation at 454°F / 240°C, this sleeve will withstand short duration exposure up to 1200°F / 648°C. The aluminum film coating melts at 460°F.

The sleeve is fabricated from a roll fabric, and is then sewn with hook & loop tape, allowing this sleeve to be installed and removed with disconnection of wiring, cables, hose and pipe. Sewing is performed with high temperature thread. The hook and loop sleeve results in a circular sleeve profile when closed. Added protection can be achieved by layering with other sleeve materials underneath the reflective layer.

The same base fabric can be used for constructing a wide variety of protective sleeves and covers.

Aluminum Film Coated Fiberglass Radiant Heat Protection Sleeve with VELCRO® Brand Hook & Loop		
Part Number	Inside Diameter inch / mm / dash#	Price / Foot 8 oz/yd ² / 11 oz/yd ²
S-FG-ALM-VCL-M019-12-X	0.75 / 19 / -12	\$ 11.17 / \$ 13.40
S-FG-ALM-VCL-M025-16-X	1.00 / 25 / -16	\$ 12.87 / \$ 15.44
S-FG-ALM-VCL-M032-20-X	1.25 / 32 / -20	\$ 14.48 / \$ 17.37
S-FG-ALM-VCL-M038-24-X	1.50 / 38 / -24	\$ 16.17 / \$ 19.40
S-FG-ALM-VCL-M044-28-X	1.75 / 44 / -28	\$ 17.87 / \$ 21.44
S-FG-ALM-VCL-M051-32-X	2.00 / 51 / -32	\$ 19.53 / \$ 23.44
S-FG-ALM-VCL-M064-40-X	2.50 / 64 / -40	\$ 22.97 / \$ 27.56
S-FG-ALM-VCL-M076-48-X	3.00 / 76 / -48	\$ 26.29 / \$ 31.55
S-FG-ALM-VCL-M089-56-X	3.50 / 89 / -56	\$ 29.68 / \$ 35.62
S-FG-ALM-VCL-M102-64-X	4.00 / 102 / -64	\$ 32.97 / \$ 39.56
Other sizes available – please enquire		

For the X value: specify "8" for construction from 8 oz/yd² fabric; specify "11" for construction from 11 oz/yd² fabric

This Product is Available By-The-Foot



**Stainless Steel Coated Fiberglass Sleeve
with VELCRO® Brand Hook & Loop Closure
1200°F / 648°C: High Temperature & Radiant Heat Reflective**



- Protection from intense radiant heat.
- Reflects more than 95% of the radiant heat that contacts its surface.
- Continuous operation at 1200°F / 648°C.
- This sleeve is the perfect protection for cables and hoses when radiant heat from infrared sources such as super-hot metal slabs, proximity to liquid metal, open flame/plasma or engine exhaust manifolds is a concern.
- The hook & loop closure allows the sleeve to be installed and removed from wire, cable, hose and pipe without disconnection.

Constructed from a high-temperature base fabric which is then coated with a layer of 0.002” thick polished stainless steel. Designed for long term continuous operation at 1200°F / 648°C this sleeve will withstand short duration exposure to higher temperatures. The stainless steel foil melts at 1220°F / 660°C, however it does take some time for the aluminum to absorb enough heat to melt – thereby it can withstand short exposure to higher temperatures.

The sleeve is fabricated from a roll fabric, and is then sewn with Velcro tape, allowing this sleeve to be installed and removed with disconnection of wiring, cables, hose and pipe. Sewing is performed with Kevlar or Fiberglass thread. The Velcro sleeve results in a circular sleeve profile when closed. Added protection can be achieved by layering with other sleeve materials underneath the reflective layer.

The same base fabric can be used for constructing a wide variety of protective sleeves and covers for EAF (Electric Arc Furnace) Cable Covers, Festoon covers, robotic welding machine covers, etc.

Fiberglass with Stainless Steel Foil Coating Radiant Heat Protection Sleeve with Velcro		
Part Number	Inside Diameter inch / mm / dash#	Price per Foot
S-FG-SS-VCL-M019-12	0.75 / 19 / -12	\$ 11.17
S-FG-SS-VCL-M025-16	1.00 / 25 / -16	\$ 12.87
S-FG-SS-VCL-M032-20	1.25 / 32 / -20	\$ 14.48
S-FG-SS-VCL-M038-24	1.50 / 38 / -24	\$ 16.17
S-FG-SS-VCL-M044-28	1.75 / 44 / -28	\$ 17.87
S-FG-SS-VCL-M051-32	2.00 / 51 / -32	\$ 19.53
S-FG-SS-VCL-M064-40	2.50 / 64 / -40	\$ 22.97
S-FG-SS-VCL-M076-48	3.00 / 76 / -48	\$ 26.29
S-FG-SS-VCL-M089-56	3.50 / 89 / -56	\$ 29.68
S-FG-SS-VCL-M102-64	4.00 / 102 / -64	\$ 32.97
Other sizes available – please enquire		

This Product is Available By-The-Foot

**Tinned Copper Metal Braided Sleeve; Tubular
HoseSaver™ / CableSaver™ : 1832°F / 1000°C: MIL QQB-575 / A-A-59569**



- Made from pure copper which has been tinned.
- Excellent Abrasion Protection.
- EMI / RFI Gasket & Sleeve.
- Provides rodent protection for burial cables and hoses.
- Braid angle allows for small amount of size expansion or compression.
- Clamps or tape can hold sleeve tight to underlying wire, cable or hose.
- Supplied in round form, spooled.
- Meets MIL QQB-575 / A-A-59569

Tinned Copper Braided Sleeve HoseSaver™ / CableSaver™					
Part Number	ID Size inch / mm		Spool Length, in feet	Price per Foot	
			Bulk / Small Spool	Bulk / Small Spool	
S-METAL-CTT-0.062-M0015-X	1/16"	1.5	250 / 100	\$ 59.38 / \$ 36.25	
S-METAL-CTT-0.109-M0028-X	7/64"	2.8	250 / 100	\$ 81.25 / \$ 45.00	
S-METAL-CTT-0.125-M0031-X	1/8"	3.1	250 / 100	\$ 96.25 / \$ 51.00	
S-METAL-CTT-0.156-M004-X	5/32"	4	250 / 100	\$ 142.50 / \$ 69.50	
S-METAL-CTT-0.203-M005-X	13/64"	5	250 / 100	\$ 235.63 / \$ 106.75	
S-METAL-CTT-0.250-M006-X	1/4"	6	250 / 100	\$ 237.50 / \$ 107.50	
S-METAL-CTT-0.375-M010-X	3/8"	10	250 / 100	\$ 251.25 / \$ 113.00	
S-METAL-CTT-0.500-M013-X	1/2"	13	100 / 50	\$ 142.00 / \$ 83.50	
* S-METAL-CTT-0.625-M016-X	5/8"	16	100 / 50	\$ 152.00 / \$ 88.50	
S-METAL-CTT-0.781-M020-X	25/32"	20	100 / 50	\$ 218.00 / \$ 121.50	
S-METAL-CTT-0.875-M022-X	7/8"	22	100 / 50	\$ 292.25 / \$ 158.63	
S-METAL-CTT-1.000-M025-X	1"	25	100 / 50	\$ 335.00 / \$ 180.00	
S-METAL-CTT-1.125-M028-X	1 1/8"	28	100 / 50	\$ 370.00 / \$ 197.50	
* S-METAL-CTT-1.250-M032-X	1 1/4"	32	100 / 50	\$ 388.88 / \$ 206.50	
S-METAL-CTT-1.375-M035-X	1 3/8"	35	100 / 50	\$ 440.50 / \$ 232.75	
S-METAL-CTT-1.500-M038-X	1 1/2"	38	100 / 50	\$ 477.00 / \$ 251.00	
S-METAL-CTT-2.000-M051-X	2	51	100 / 50	\$ 526.25 / \$ 275.63	
* S-METAL-CTT-2.250-M057-X	2 1/4	57	100 / 50	\$ 611.50 / \$ 318.25	

For the "X" value: use "B" for Bulk Spool size, use "S" for Small Spool size, use "F" for By The Foot

Part numbers marked with * are not specified in the MIL Spec

Tinned Copper Metal Braided Sleeve; Tubular

HoseSaver™ / CableSaver™ : 1832°F / 1000°C: MIL QQB-575 / A-A-59569

Meets MIL QQB-575 / A-A-59569

Electrical Specifications

Tinned Copper Braided Sleeve Electrical Specifications HoseSaver™ / CableSaver™				
Part Number	AWG of Individual Wires	Carriers	Wires per Carrier	Current Capacity Amps
S-METAL-CTT-0.062-M0015-X	36	24	2	11
S-METAL-CTT-0.109-M0028-X	36	24	4	19
S-METAL-CTT-0.125-M0031-X	36	24	5	25
S-METAL-CTT-0.156-M004-X	36	24	10	40
S-METAL-CTT-0.203-M005-X	32	24	5	46
S-METAL-CTT-0.250-M006-X	36	24	16	53
S-METAL-CTT-0.375-M010-X	36	48	8	53
S-METAL-CTT-0.500-M013-X	36	48	11	62
* S-METAL-CTT-0.625-M016-X	34	48	8	64
S-METAL-CTT-0.781-M020-X	36	48	18	88
S-METAL-CTT-0.875-M022-X	30	48	7	100
S-METAL-CTT-1.000-M025-X	30	48	8	120
S-METAL-CTT-1.125-M028-X	30	48	9	130
* S-METAL-CTT-1.250-M032-X	30	48	10	145
S-METAL-CTT-1.375-M035-X	30	48	11	150
S-METAL-CTT-1.500-M038-X	30	48	12	165
S-METAL-CTT-2.000-M051-X	30	48	14	180
* S-METAL-CTT-2.250-M057-X	30	48	16	190

Part numbers marked with * are not specified in the MIL Spec



Tinned Copper Metal Braided Sleeve; Flat
HoseSaver™ / CableSaver™ : 1832°F / 1000°C: MIL QQB-575 / A-A-59569

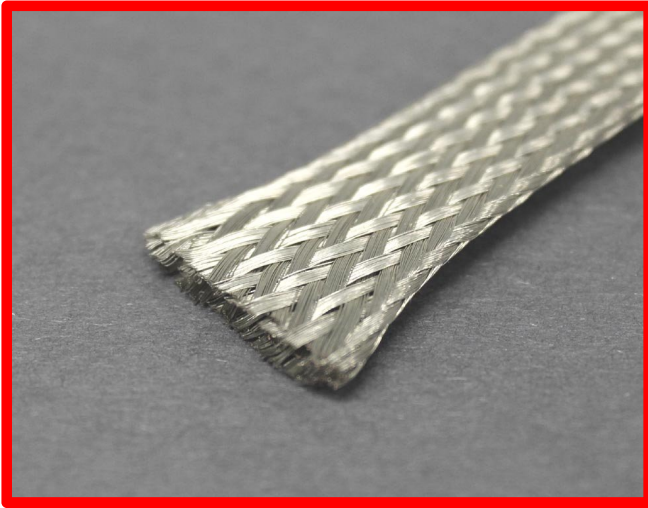

- Made from Pure Copper. Then Tinned.
- Excellent Abrasion Protection.
- EMI / RFI Gasket & Sleeve.
- Provides Blow-out protection for hydraulic hoses.
- Provides rodent protection for burial cables and hoses.
- Braid angle allows for small amount of size expansion or compression.
- Clamps or tape can hold sleeve tight to underlying wire, cable or hose.
- Supplied in flat form, spooled.
- Meets MIL QQB-575 / A-A-59569

Tinned Copper Braided Sleeve: Flat HoseSaver™ / CableSaver™					
Part Number	ID Size inch / mm		Spool Length, in feet Bulk / Small Spool	Price per Foot Bulk / Small Spool	Price per Foot
	S-METAL-CTF-0.125-M0031-X	1/8"			
S-METAL-CTF-0.187-M005-X	3/16"	5	250 / 100	\$ 123.12 / \$ 61.75	\$ 1.85
S-METAL-CTF-0.250-M006-X	1/4"	6	250 / 100	\$ 194.37 / \$ 90.25	\$ 2.71
* S-METAL-CTF-0.375-M010-X	3/8"	10	250 / 100	\$ 245.00 / \$ 110.50	\$ 3.32
S-METAL-CTF-0.625-M016-X	5/8"	16	100 / 50	\$ 120.50 / \$ 72.75	\$ 4.36
S-METAL-CTF-0.750-M019-X	3/4"	19	100 / 50	\$ 229.50 / \$ 127.25	\$ 7.63
* S-METAL-CTF-1.000-M025-X	1"	25	100 / 50	\$ 362.75 / \$ 193.87	\$ 11.63
S-METAL-CTF-1.375-M035-X	1 3/8"	35	100 / 50	\$ 418.00 / \$ 221.50	\$ 13.29
S-METAL-CTF-1.500-M038-X	1 1/2"	38	100 / 50	\$ 471.25 / \$ 248.12	\$ 14.88
* S-METAL-CTF-2.000-M051-X	2	51	50 / 50	\$ 526.12 / \$ 338.62	\$ 32.31
* S-METAL-CTF-3.000-M076-X	3	76	50 / 25	\$ 884.50 / \$ 454.75	\$ 54.57

For the "X" value:
 use "B" for Bulk Spool size, use "S" for Small Spool size, use "F" for By The Foot

Part numbers marked with * are not specified in the MIL Spec

Tinned Copper Metal Braided Sleeve; Flat

HoseSaver™ / CableSaver™ : 1832°F / 1000°C: MIL QQB-575 / A-A-59569

Meets MIL QQB-575 / A-A-59569

Electrical Specifications

Tinned Copper Braided Sleeve Electrical Specifications HoseSaver™ / CableSaver™				
Part Number	AWG of Individual Wires	Carriers	Wires per Carrier	Current Capacity Amps
S-METAL-CT-0.125-M0031-X	36	24	3	16
S-METAL-CT-0.187-M005-X	36	24	5	25
S-METAL-CT-0.250-M006-X	36	24	10	40
S-METAL-CT-0.375-M010-X	36	48	6	40
S-METAL-CT-0.625-M016-X	36	48	8	53
S-METAL-CT-0.750-M019-X	36	48	18	88
S-METAL-CT-1.000-M025-X	36	48	18	85
S-METAL-CT-1.375-M035-X	30	48	7	100
S-METAL-CT-1.500-M038-X	30	48	11	145
S-METAL-CT-2.000-M051-X	30	48	28	255
S-METAL-CT-3.000-M076-X	30	48	47	390

Part numbers marked with * are not specified in the MIL Spec

**Brass Metal Braided Sleeve; Tubular
HoseSaver™ / CableSaver™ : 1472°F / 800°C**

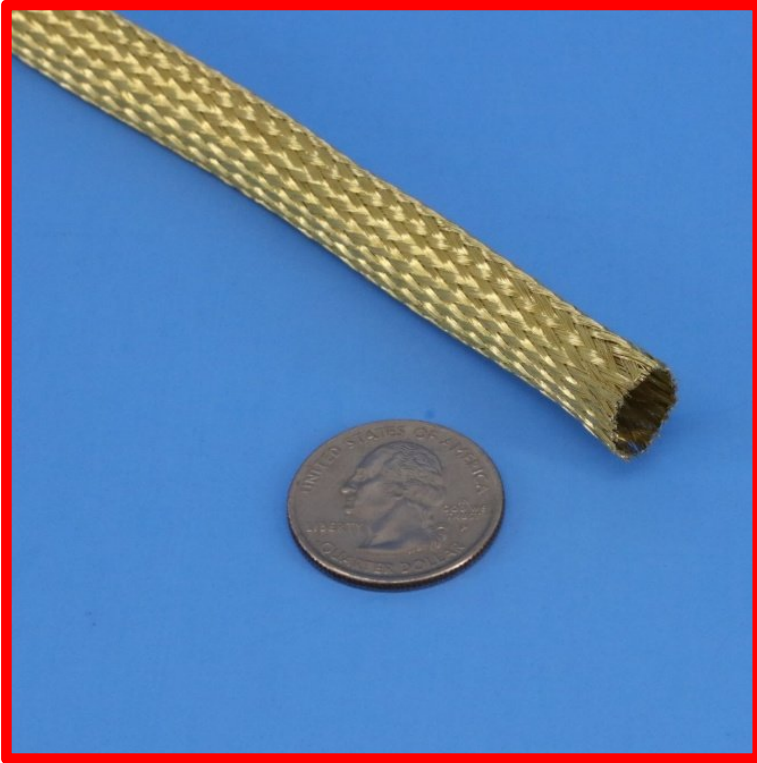

- Made from brass (copper/zinc alloy).
- Antimicrobial.
- EMI / RFI Gasket & Sleeve.
- Provides rodent protection for burial cables and hoses.
- Braid angle allows for size expansion.
- Clamps or tape can hold sleeve tight to underlying wire, cable or hose.
- Supplied in flattened form, spooled. Easily re-tubularized.
- Popular for improving aesthetic appearance of hoses and wiring on automotive and industrial equipment.

Brass Braided Sleeve HoseSaver™ / CableSaver™					
Part Number	Nominal ID inch / mm	ID Range inch / mm		Spool Length, feet Bulk / Small Spool	Price per Spool Bulk / Small
S-METAL-BRA-0.125-M0031-X	1/8 / 3.1	1/8" – 1/4"	3.1 - 6	250 / 25	\$ 337.50 / \$ 46.25
S-METAL-BRA-0.250-M006-X	¼ / 6	1/4" – 3/8"	6 - 10	100 / 25	\$ 362.50 / \$ 103.12
S-METAL-BRA-0.375-M010-X	3/8 / 10	3/8" – ¾"	10 – 19	100 / 25	\$ 380.00 / \$ 107.50
S-METAL-BRA-0.500-M013-X	½ / 12.7	½" – 1"	12.7 - 25	100 / 25	\$ 497.00 / \$ 137.50

Wall Thickness: 0.125 ID - .015". 0.250 ID - .027". 0.375 ID - .015". 0.500 ID - .020"

For the "X" value: use "B" for Bulk Spool size, use "S" for Small Spool size

Stainless Steel Metal Braided Sleeve; Round – Hose Size / Heavy Duty HoseSaver™ / CableSaver™ : 2500°F / 1371°C:



- Designed for common hose sizes. Made from 304L Stainless Steel. 321 and 316 Stainless Available.
- Excellent Abrasion Protection.
- EMI / RFI Gasket & Sleeve.
- Provides Blow-out protection for hydraulic hoses.
- Provides rodent protection for burial cables and hoses.
- Also available in Bronze, Monel, Inconel Copper and Hastelloy.
- Braid angle allows for small amount of size expansion or compression.
- Clamps or tape can hold sleeve tight to underlying wire, cable or hose.
- Supplied as a round sleeve, coiled and boxed.

“Hose” Size 304L Tubular Stainless Steel Braided Sleeve HoseSaver™ / CableSaver™

Part Number	Actual Size I.D. inch / mm	“Hose” Size inch / mm		Braid coverage %	Weight per foot in lbs.	Price per Foot
S-METAL-SS-HS-M006-04	0.50 / 13	1/4"	6	89	.08	\$ 7.21
S-METAL-SS-HS-M010-06	0.67 / 17	3/8"	10	91	.12	\$ 7.87
S-METAL-SS-HS-M013-08	0.82 / 21	1/2"	13	82	.16	\$ 8.75
S-METAL-SS-HS-M019-12	1.21 / 31	3/4"	19	90	.20	\$ 10.12
S-METAL-SS-HS-M025-16	1.51 / 38	1"	25	85	.23	\$ 13.34
S-METAL-SS-HS-M032-20	1.85 / 47	1 1/4"	32	83	.31	\$ 13.50
S-METAL-SS-HS-M035-24	2.19 / 55	1 1/2"	35	87	.40	\$ 16.87
S-METAL-SS-HS-M051-32	2.60 / 66	2	51	89	.62	\$ 18.00
S-METAL-SS-HS-M063-40	3.23 / 82	2 1/2	63	86	.70	\$ 19.13
S-METAL-SS-HS-M076-48	3.78 / 96	3	76	85	.80	\$ 20.25
S-METAL-SS-HS-M101-64	4.85 / 123	4	101	84	1.00	\$ 22.50
S-METAL-SS-HS-M127-80	5.90 / 150	5	127	74	1.25	\$ call
S-METAL-SS-HS-M152-96	6.87 / 174	6	152	90	1.60	\$ call
S-METAL-SS-HS-M203-128*	9.09 / 231	8	203	96	3.87	\$ call
S-METAL-SS-HS-M254-160*	11.18 / 284	10	254	98	6.05	\$ call
S-METAL-SS-HS-M305-192*	13.23 / 336	12	305	97	5.81	\$ call
S-METAL-SS-HS-M355-224*	14.70 / 373	14	355	99	7.89	\$ call

This Product is Available By-The-Foot: Standard lengths up to 100 feet available

A note about sizes: The “Hose” sizes refer to the nominal hose size. For example: a 1/4” “Hose” size nominal braided stainless sleeve is actually 0.48” ID, which would be the nominal OD of a 1/4” hose. For “standard” size stainless sleeve see next catalog page..

* Braided braid



Stainless Steel Metal Braided Sleeve
XL High Coverage flat sleeve; SD Standard Coverage round sleeve
2500°F / 1371°C: Standard Size HoseSaver™ / CableSaver™



- “Standard” size stainless braid sleeve: an alternative to “Hose” size sleeve.
- Flexible size – can expand or shrink by approx 25% due to the high braid angle. Expanded position results in slightly lower braid coverage.
- Excellent Abrasion Protection.
- EMI / RFI Gasket & Sleeve.
- Provides Blow-out protection for hydraulic hoses.
- Provides rodent protection for burial cables and hoses.
- Clamps, tape or ties can hold the sleeve tight to underlying wire, cable or hose if required, and at the connector ends.
- S-METAL-SS-XL is supplied as a flat sleeve, on spools. S-METAL-SS-SD is supplied as round.
- S-METAL-SS-XL is a high coverage braid allowing greater expandability than the S-METAL-SS-SD version.

“Standard” Size 304L Tubular Stainless Steel Braided Sleeve
HoseSaver™ / CableSaver™

Part Number	ID Size		Size Range	Wall Thickness	Spool Length, feet Bulk / Small Spool	Price per Spool Bulk / Small Spool
	inch	mm				
S-METAL-SS-XL-M0015-01-X	1/16"	1.5	Nominal	.013"	250 / 100	\$ 237.50 / \$ 111.66
S-METAL-SS-XL-M003-02-X	1/8"	3	1/16 – 11/32	.013"	250 / 100	\$ 375.00 / \$ 166.66
S-METAL-SS-XL-M006-04-X	1/4"	6	3/16 – 13/32	.013"	250 / 100	\$ 464.16 / \$ 202.33
S-METAL-SS-XL-M010-06-X	3/8"	10	¼ - 5/8	.013"	250 / 100	\$ 808.33 / \$ 340.00
S-METAL-SS-XL-M013-08-X	1/2"	13	3/8 – 3/4	.013"	100 / 50	\$ 330.66 / \$ 182.00
S-METAL-SS-XL-M019-12-X	3/4"	19	½ - 1 1/4	.013"	100 / 50	\$ 640.00 / \$ 336.66
S-METAL-SS-XL-M025-16-X	1"	25	5/8 – 1 5/16	.025"	100 / 50	\$ 866.00 / \$ 450.00
S-METAL-SS-XL-M032-20-X	1 1/4"	32	¾ - 1 3/4	.025"	100 / 50	\$ 1083.33 / \$ 558.33
S-METAL-SS-XL-M035-24-X	1 1/2"	35	1 – 2 1/8	.025"	100 / 50	\$ 1166.66 / \$ 600.00
S-METAL-SS-SD-M013-08-X	1/2"	13	1/4" - 5/8"	.025"	100 / 25	\$ 816.66 / \$ 220.83
S-METAL-SS-SD-M016-10-X	5/8"	16	3/8" - 3/4"	.025"	100 / 25	\$ 833.33 / \$ 225.00
S-METAL-SS-SD-M019-12-X	3/4"	19	1/2 - 1"	.025"	100 / 25	\$ 855.66 / \$ 230.56
S-METAL-SS-SD-M025-16-X	1"	25	3/4" - 1 1/4"	.025"	100 / 25	\$ 1039.00 / \$ 276.40
S-METAL-SS-SD-M032-20-X	1 1/4"	32	1 - 1 1/2	.035"	100 / 25	\$ 1489.00 / \$ 388.90
S-METAL-SS-SD-M044-28-X	1 3/4"	44	1 1/2 - 2 1/4	.040"	100 / 25	\$ 1816.66 / \$ 470.83

For the “X” value: use “B” for Bulk Spool size, use “S” for Small Spool size

For “Hose” size stainless sleeve see previous page



Stainless Steel Hollow Knitted Mesh Sleeve

1200°F / 648°C:

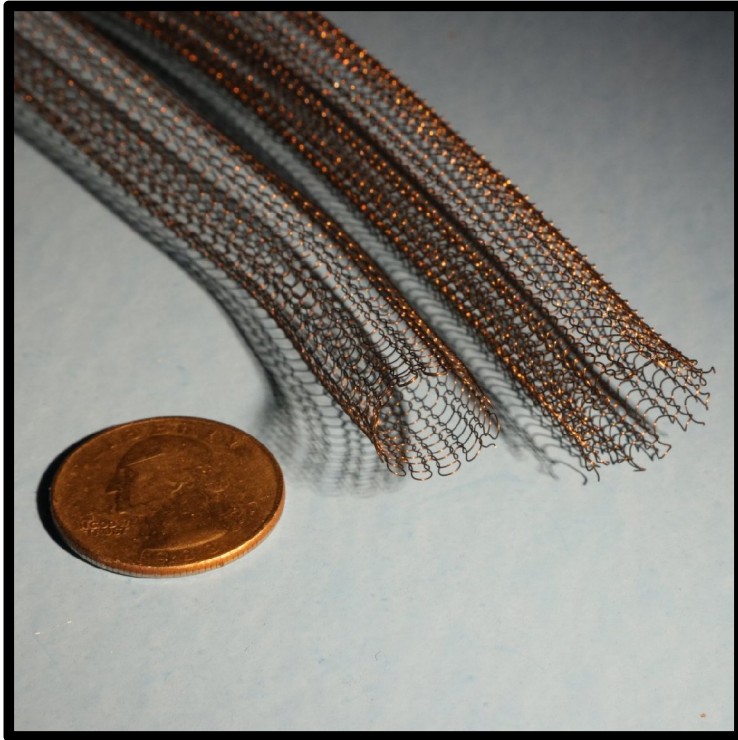

- Excellent Compressability and pushback with no compression set.
- Provides abrasion protection.
- Excellent EMI / RFI Gasket.
- Used as a bulb material in some tadpole and gasket ropes instead of solid mesh rope for added compressability of the bulb.
- 304 Stainless

304 Stainless Steel Hollow Knitted Mesh Sleeve				
ID Size inch / mm		Part Number	Feet per Carton	Price per Carton
1/4"	6	S-SS-HOLLOW-M006-04	1000	\$ 1600.00
3/8"	10	S-SS-HOLLOW-M010-06	1000	\$ 1700.00
1/2"	13	S-SS-HOLLOW-M013-08	500	\$ 1065.00
5/8"	16	S-SS-HOLLOW-M016-10	500	\$ 1115.00
3/4"	19	S-SS-HOLLOW-M019-12	500	\$ 1150.00

Please call for additional discount pricing when ordering more than 2 cartons.



Solid Wall Stainless Steel Flexible Sleeve

1200°F / 648°C:



- Annular corrugated construction provides ability to easily flex and bend, compress and expand.
- Excellent abrasion and splash Protection.
- EMI / RFI Shield.
- Provides Blow-out protection for hydraulic hoses.
- Provides rodent protection for burial cables and hoses.
- Wires cables and hoses can be spiral wrapped with tapes prior to insertion for insulation spacing to the sidewall.
- Range of fittings and connection flanges available to terminate sleeve onto metalwork, bulkheads, etc.
- Available in Bronze, Monel, Inconel & Hastelloy

This

Solid Wall Stainless Steel Flexible Sleeve							
Part Number	Nominal ID inch / mm		Min Bend Radius inch		Weight per foot	Price per Foot	Mill Lengths feet
			Static / Dynamic				
S-METAL-SS-SW-M008-04	.32	8	4	6	0.09	\$ 6.83 *	30-100
S-METAL-SS-SW-M011-06	.42	11	2	4	0.12	\$ 7.73	30-100
S-METAL-SS-SW-M013-08	.52	13	3	5	0.16	\$ 7.90	30-100
S-METAL-SS-SW-M020-12	.81	20	4	6	0.26	\$ 10.23	30-100
S-METAL-SS-SW-M026-16	1.03	26	4.5	7	0.36	\$ 14.27	30-100
S-METAL-SS-SW-M033-20	1.30	33	4	11	0.45	\$ 17.27	30-60
S-METAL-SS-SW-M039-24	1.53	39	4.5	12	0.48	\$ 19.70	30-60
S-METAL-SS-SW-M052-32	2.05	52	5	13	0.70	\$ 24.97	30-60
S-METAL-SS-SW-M066-40	2.61	66	5	13	1.28	\$ 40.13	7-20
S-METAL-SS-SW-M079-48	3.10	79	7.5	16	1.53	\$ 43.97	7-20
S-METAL-SS-SW-M089-56	3.50	89	8	17	1.65	\$ 54.50 *	7-20
S-METAL-SS-SW-M101-64	3.98	101	10	20	1.95	\$ 54.30	7-20
S-METAL-SS-SW-M128-80	5.03	128	12	24	2.76	\$ 88.67	7-20
S-METAL-SS-SW-M152-96	5.98	152	15	30	3.34	\$ 92.87	7-20
S-METAL-SS-SW-M202-128	7.96	202	20	40	5.32	\$ 161.60	5-12
S-METAL-SS-SW-M248-157	9.78	248	25	50	8.71	\$ 198.85	5-12
S-METAL-SS-SW-M299-188	11.76	299	30	60	11.58	\$ 231.68	5-12
S-METAL-SS-SW-M346-217	13.62	346	35	70	14.57	\$ 753.47	5-12

Product is Available By-The-Foot

Supplied in 304SS as standard. Except (*) supplied in 321SS

Also Available in 321 & 316 Stainless, Bronze, Monel, Inconel and Hastelloy, please call for pricing



EMI / RFI Wire and Cable Harness Shielding Sleeve

302°F / 150°C: FlameShield™



- Lightweight
- Extreme Flexibility
- Excellent Electro-Magnetic Interference and Radio Frequency Interference (EMI / RFI) Shielding 1 MHz to 1 GHz
- Aramid fiber with conductivity
- Expandability
- Approximate 20% attenuation at maximum expanded diameter

- End-to-end shielding solution



FlameShield™ EMI/RFI Wire & Cable Shielding Sleeve						
Part Number	ID Size inch / mm		Expansion Range		Feet per Spool	Price per Spool
S-EMI-M003-02	1/8"	3	1/16	1/4	164	\$ 1234.92
S-EMI-M010-06	3/8"	10	1/4	1/2	164	\$ 1805.64
S-EMI-M013-08	1/2"	13	3/8	3/4	164	\$ 2091.13
S-EMI-M019-12	3/4"	19	1/2	1	164	\$ 2509.20

Not available By-The-Foot

Exhaust Hose Ducting - High Temperature & Heat Resistant 1500°F / 815°C: FlameShield™



- Designed for extracting fumes from metal fabrication works; refining, smelting, forging.
- Makes a great large air gap heat shield to cover piping, wires and cables.
- Constructed of a 3 ply non-flammable, lightweight and flexible ceramic coated hose, with a V4A internal stainless steel wire.
- Has an external steel wearstrip for abrasion resistance.
- Only sold in full coil lengths of 25 feet.

High Temperature Exhaust Hose / Ducting for Metal Processing							
Part Number	ID Size inch / mm		Working Pressure	Vacuum	Bend Radius	Weight / ft	Price per Foot
H-C-M102-64	4"	102	4 #	8	8"	1.5	\$ 184.00
H-C-M127-80	5"	127	3 #	6	10"	1.8	\$ 218.00
H-C-M152-96	6"	152	2 #	6	12"	2.2	\$ 262.50
H-C-M203-128	8"	203	1 #	5	16"	3	\$ 300.00
H-C-M254-160	10"	254	1 #	4	20"	3.5	\$ 371.50
H-C-M305-192	12"	305	1 #	3	24"	3.85	\$ 449.50



Exhaust Hose for Welding Applications

300°F / 148°C:



- Designed for extracting fumes from welding operations.
- Constructed of a fiberglass base material with an aluminized PET film coating. Bonded to a helix.
- Only sold in full coil lengths of 25 feet.

High Temperature Exhaust Hose / Ducting for Welding Applications							
Part Number	ID Size inch / mm		Working Pressure	Vacuum	Bend Radius	Weight / ft	Price per Foot
H-FG-AL-M102-64	4"	102	4 #	2.7	6"	1.15	\$ 9.32
H-FG-AL-M127-80	5"	127	4 #	2.4	7.5"	1.25	\$ 10.64
H-FG-AL-M152-96	6"	152	3 #	2.2	9"	1.34	\$ 13.32
H-FG-AL-M203-128	8"	203	3 #	1.8	12"	1.75	\$ 17.98

Wire, Cable, Harness and Hose Overbraid Service Thermal Protection / Abrasion Protection / Organization

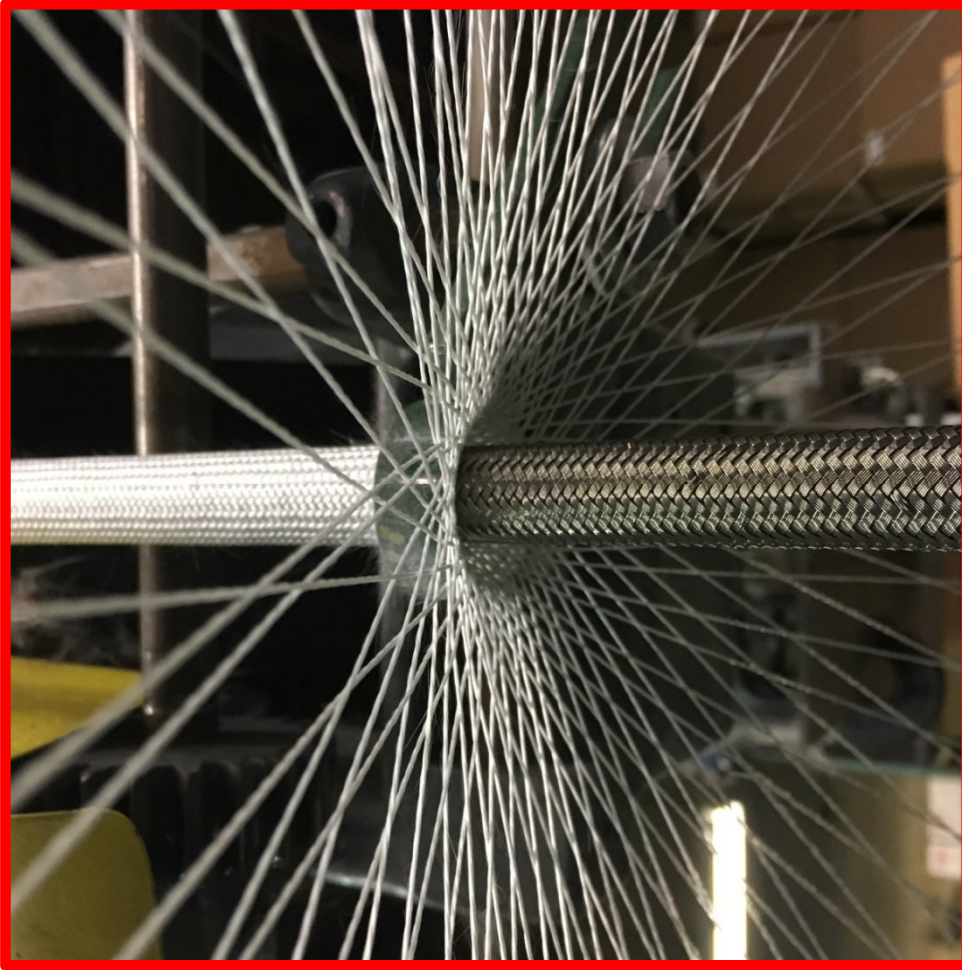

Our in-house braiding capability and experience allows us to provide exceptional quality and a timely response to protect your wiring, cables and hoses.

Available overbraid materials include e-fibreglass filament, Kevlar[®], Nomex[®], Nylon, PET, Polyester and Stainless wire

Please provide a description of your materials and sizing to allow us to provide an accurate quotation.

Kevlar[®] & Nomex[®] are trademarks of DuPont™



**Standard Sleeving Sizes: Inside Diameter and Wall Thickness Specifications
For S-FS-SD, S-FG-S, S-FG-E Sleeve**

AWG Size	Nominal Size				Inside Diameter				Wall Thickness	
	AWG	in.	mm.	dash	Min / Max inches		Min / Max millimeter		In.	mm.
AWG 24	24	0.022	0.56	NA	0.020	0.027	0.508	0.685	0.011	0.279
AWG 22	22	0.027	0.69	NA	0.025	0.032	0.638	0.812	0.013	0.330
AWG 20	20	0.034	0.86	NA	0.032	0.039	0.812	0.990	0.013	0.330
AWG 19	19	0.038	0.96	NA	0.036	0.044	0.914	1.117	0.013	0.330
AWG 18	18	0.042	1.07	NA	0.040	0.049	1.016	1.244	0.015	0.381
AWG 17	17	0.047	1.19	NA	0.045	0.054	1.143	1.371	0.015	0.381
AWG 16	16	0.053	1.35	NA	0.051	0.061	1.295	1.549	0.015	0.381
AWG 15	15	0.059	1.50	NA	0.057	0.067	1.447	1.701	0.015	0.381
AWG 14	14	0.066	1.68	-01	0.064	0.074	1.625	1.879	0.015	0.381
AWG 13	13	0.076	1.93	NA	0.072	0.082	1.828	2.087	0.015	0.381
AWG 12	12	0.085	2.16	NA	0.081	0.091	2.057	2.311	0.015	0.381
AWG 11	11	0.095	2.41	NA	0.091	0.101	2.311	2.565	0.018	0.457
AWG 10	10	0.106	2.69	NA	0.102	0.112	2.59	2.844	0.018	0.457
AWG 9	9	0.118	3.10	NA	0.114	0.124	2.895	3.149	0.018	0.457
AWG 8	8	0.133	3.38	-02	0.129	0.141	3.276	3.581	0.018	0.457
AWG 7	7	0.148	3.76	NA	0.144	0.158	3.657	4.013	0.018	0.457
AWG 6	6	0.166	4.22	NA	0.162	0.178	4.114	4.521	0.020	0.508
AWG 5	5	0.186	4.72	-03	0.182	0.198	4.622	5.029	0.020	0.508
AWG 4	4	0.208	5.28	NA	0.204	0.224	5.181	5.689	0.020	0.508
AWG 3	3	0.234	5.94	NA	0.229	0.249	5.816	6.324	0.020	0.508
AWG 2	2	0.263	6.68	-04	0.258	0.278	6.553	7.061	0.020	0.508
AWG 1	1	0.294	7.47	NA	0.289	0.311	7.340	7.899	0.020	0.508
05	5/16	0.313	7.95	-05	0.312	0.334	7.924	8.483	0.020	0.508
AWG 0	0	0.330	8.38	NA	0.325	0.347	8.255	8.813	0.025	0.635
06	3/8	0.375	9.52	-06	0.375	0.399	9.525	10.134	0.025	0.635
07	7/16	0.438	11.12	-07	0.438	0.462	11.12	11.734	0.025	0.635
08	1/2	0.500	12.70	-08	0.500	0.524	12.70	13.309	0.025	0.635
10	5/8	0.625	15.87	-10	0.625	0.655	15.87	16.637	0.025	0.635
12	3/4	0.750	19.05	-12	0.750	0.786	19.05	19.964	0.025	0.635
14	7/8	0.875	22.22	-14	0.875	0.911	22.22	23.139	0.025	0.635
16	1	1.000	25.40	-16	1.000	1.036	25.00	26.314	na	

Sleeving Splices

Most sleeving is produced to NEMA TF 1 1993, which allows for the following maximum number of splices; 50 foot spool, 2 splices; 100 foot, 3 splices; 150 foot, 3 splices; 250 foot, 4 splices; 500 foot, 7 splices; 1000 foot, 10 splices. Please enquire if you require splice free lengths.

Tapes / Tadpole Tapes / Lacing Tapes

Tapes

FlameShield™ Kevlar Aramid Tape / Webbing Mil-T-87130	2-1
FlameShield™ Glass Cloth Tape with Silicone Adhesive Mil-I-19166C	2-2
FlameShield™ Glass Cloth Tape with Silicone Adhesive	2-3
FlameShield™ Silicone Rubber Coated Fiberglass Tape, 1 and 2 side coated	2-4
FlameShield™ Silicone Rubber Self-fusing Tapes	2-8
DeltaGlass™ Fiberglass with PTFE Coating Gasket Tape, Plain & Ladder (Bolt-Hole)	2-50
DeltaGlass™ Fiberglass with PTFE Resin Impregnation & Self Adhesive	2-52
DeltaGlass™ Skived PTFE with Self Adhesive	2-54
Expanded PTFE ePTFE Joint Seal Tape	2-56
Tuff-Flex™ Rubberized Fiberglass Tacky Cloth Gasket Tape	2-57
Tuff-Flex™ Rubberized Fiberglass Luting & Groove Packing	2-58
DeltaGlass™ Fiberglass Woven Electrical Apparatus Insulating Tapes	2-59
DeltaGlass™ Fiberglass Knit and Woven Gasket & Insulating Tapes, Plain & Ladder (Bolt-Hole)	2-60
ProSil™ Fiberglass / Silica Blend Woven Gasket and Insulating Tapes, Plain & Ladder (Bolt-Hole)	2-70
Vermiculite Coated DeltaGlass™ Fiberglass Woven Tape, Plain & Ladder (Bolt-Hole)	2-72
PowerTorque™ Automotive Manifold, Header, Turbo and Exhaust Tapes	2-77
InSilMax™ Silica Tapes: Slit – Folded & Stitched – Woven	2-78
CerMax™ Ceramic Fiber Tape	2-84
GraphTek™ Graphite Flexible Tape	2-86
Radiant Heat Reflecting Tapes	2-87
Weld Backing Tape	2-93
Insulated Wrap – for Pipe / Hose / Cable Protection – Steam Pipe & Heat Trace Insulation	2-94
Pressure Sensitive Adhesive Spray for tape mounting	2-98
Pressure Sensitive Mounting tape	2-99

Tadpole Tapes

500°F / 260°C Silicone Rubber Tadpole Gasket Seals	2-101
320°F / 160°C Aramid High Strength Tadpole Gasket Seals	2-102
1200°F / 648°C Precision Fiberglass Tadpole Seal	2-103
1200°F / 648°C Fiberglass, with rope or stainless filled bulb Tadpole Seal	2-104
1350°F / 732°C ProSil Fiberglass/Silica Blend Tadpole Seal	2-105
1350°F / 732°C ProSilMax Fiberglass/Silica Blend with Wire Insert Tadpole Seal	2-106
1500°F / 815°C Fiberglass with Vermiculite Coating, with rope or stainless filled bulb	2-107
1800°F / 982°C InSilMax and InSiIMax XT with rope or stainless filled bulb	2-108
2000°F / 1093°C CerMax with rope or stainless filled bulb	2-110

Tadpoles with Specialized Coatings

Fiberglass with PTFE Coating with rope or stainless filled bulb Tapole Seal	2-112
Rubberized Fiberglass Tacky Cloth with rope or stainless filled bulb Tadpole Seal	2-113
Expanded PTFE ePTFE with rope or stainless filled bulb Tadpole Seal	2-114

High Temperature, Heat, Flame, Fire, Molten Metal & Weld Splatter Protection Materials

Fax Orders: 610-340-9054 Telephone Orders: 610-906-3549 orders@abthermal.com



Mil-i-19166 fiberglass tape with silicone adhesive. UL. Page 2-1



1 Side Coated Tape & Wrap. Page 2-3 & 2-4

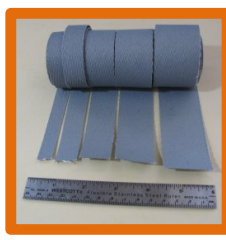

2 Side Coated Tape & Wrap. Page 2-5

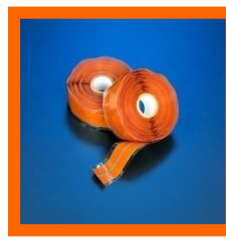

Silicone Self-fusing End Wrap Tape Page 2-6 – 2-20



High Temperature Chemical Resistant Woven Tapes with PTFE Coating. Page 2-21



High Temperature Chemical Resistant Tapes with PTFE Impregnation. Page 2-23



High Temperature Chemical Resistant Skived PTFE Tape Page 2-25



High Temperature Chemical Resistant ePTFE Joint Seal Tape. Page 2-26



High Temperature Rubberized Tacky Cloth Tape. Page 2-27



Very High Temperature Knitted Tapes: Plain & Bolt Hole / Ladder Tape. Page 2-29



Very High Temperature Woven Tapes. Page 2-30



Very High Temperature Woven Tape: Special Thin. Extra Thick, Extra Wide Page 2-32



Vermiculite Coated High Temperature Tape. Page 2-38



PowerTorque Automotive Header, Manifold & Exhaust Tapes. Page 2-41



Extreme Temperature InSiMax Tapes: Slit, Folded & Stitched, Woven Page 2-42



Extreme Heat Ceramic Fiber Tape Page 2-46



Extreme Heat Graphite Tape Page 2-47

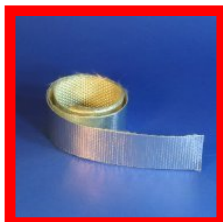

Radiant Heat Reflective Protection Tape. Page 2-48



High Temperature Precision Tadpole Gaskets. Page 2-55



High Temperature Tadpole Tape. Page 2-56



Pressure Sensitive Adhesive Tape Spray Page 2-53



Kevlar® Woven Aramid Tape Premium Grade

320°F / 160°C: FlameShield™ : High Temperature & Heat Resistant, High Strength Tape / Webbing

Meets MIL-T-87130



- Soft and pliable, highly flexible.
- Halogen & asbestos free.
- 20 times stronger than steel.
- Highly cut resistant.
- Available in natural (yellow) color.

320°F / 160°C maximum continuous rating with high insulation value & excellent personnel protection. Short term exposure to 572°F / 300°C

FlameShield™ High Temperature & Heat Resistant Woven Kevlar® Aramid Tape - Premium Grade				
Part Number	Width	Thickness	Tensile Strength, lbs	Price per Foot
T-KF-W-M025-16-014	1"	.014"	1500	\$ Call
T-KF-W-M025-16-025	1"	.025"	2500	\$ Call
T-KF-W-M025-16-055	1"	.055"	6000	\$ Call
T-KF-W-M038-24-023	1.5"	.023"	3000	\$ Call
T-KF-W-M038-24-057	1.5"	.057"	NA	\$ Call
T-KF-W-M038-24-069	1.5"	.069"	NA	\$ Call
T-KF-W-M038-24-079	1.5"	.079"	NA	\$ Call



Fiberglass Glass Cloth Fine Weave Tape with Silicone Adhesive meets MIL-I-19166
392°F / 200°C: Glass Cloth High Temperature & Heat Resistant High Adhesion Tape - Electrical Insulation Tape meeting MIL-I-19166

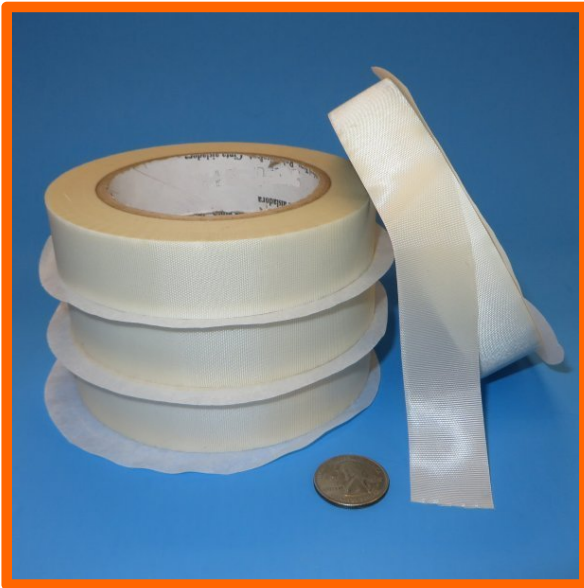

- FlameShield™ 19166 and RG48 glass cloth tape is a high temperature fine weave fiberglass tape with a very high adhesion silicone adhesive.
- 3000 volt dielectric strength.
- .007" total thickness (5mil glass w/2 mil adhesive).
- UL recognized and meets Mil-i-19166C.
- Non Mil-Spec version available.
- Adhesion of 40oz/in.
- Tensile strength 180 lbs/in.
- NEMA Insulation class "H". Maximum continuous temperature of 356°F / 180°C.
- Practical short term exposure to 392°F / 200°C.
- Base glass material rated for 1200°F / 648°C. Silicone adhesive will "smoke" off at temperatures above 460°F / 237°C.
- This tape is widely used for electrical installations and repairs. Used on splices requiring high abrasion resistance and mechanical strength. Widely used in Marine and aviation applications.

FlameShield™ High Temperature Fiberglass Tape with Silicone Adhesive UL Recognized & Meets Mil-I-19166			
Part Number	Tape Width inch / mm		Price per Roll
T-FG-SA-19166-M013-08	0.5	13	\$ 35.84
T-FG-SA-19166-M025-16	1.0	25	\$ 66.25
T-FG-SA-19166-M038-24	1.5	38	\$ 130.33
T-FG-SA-19166-M051-32	2.0	51	\$ 173.77

- 0.5" and 1" wide tapes are normally stock; 1.5" and 2" wide are custom slit from a log and usually takes 2 to 3 days to process through our cutting room.
- This tape is slit from a master log - other widths than those listed are available.
- Standard length is 66 Feet / 20 Metres, rolled.
- RG48 part number applies.



Glass Cloth Electrical Tape with Silicone Adhesive
500°F / 260°C: High Temperature & Heat Resistant High Adhesion Tape - Mechanical and Electrical



- FlameShield™ glass cloth tape is a high temperature fine weave fiberglass tape with a very high adhesion silicone adhesive.
- 3000 volt dielectric strength.
- .007" total thickness.
- Adhesion of approx 40oz/in.
- Tensile strength approx 180 lbs/in.
- This tape is widely used for electrical installations and repairs. Used on splices requiring high abrasion resistance and mechanical strength.
- Mil-Spec version meeting MIL-I-19166 available -widely used in marine and aviation applications.
- Used for masking in paint spray applications
- Used on heat sealing machinery for higher temperature performance than ptfе tapes.

FlameShield™ High Temperature High Strength Fiberglass Glass Cloth Tape with Silicone Adhesive			
Part Number	Tape Width		Price per Roll
	inch	mm	
T-FG-SA-M003-02	0.125	3.17	\$ 5.20
T-FG-SA-M006-04	0.250	6.35	\$ 10.40
T-FG-SA-M010-06	0.375	10	\$ 15.26
T-FG-SA-M013-08	0.500	13	\$ 20.46
T-FG-SA-M016-10	0.625	16	\$ 25.30
T-FG-SA-M019-12	0.750	19	\$ 32.23
T-FG-SA-M022-14	0.875	22	\$ 35.70
T-FG-SA-M025-16	1.00	25	\$ 40.57
T-FG-SA-M032-20	1.25	32	\$ 50.60
T-FG-SA-M038-24	1.50	38	\$ 60.66
T-FG-SA-M045-28	1.75	45	\$ 69.06
T-FG-SA-M051-32	2.00	51	\$ 79.13
T-FG-SA-M064-40	2.50	64	\$ 96.23
T-FG-SA-M076-48	3.00	76	\$ 111.50
T-FG-SA-M102-64	4.00	102	\$ 127.93
T-FG-SA-M152-96	6.00	152	\$ 192.66

Standard length is 108 feet / 36 Yards / 32.9 Metres

- This tape is slit from a master log - other widths than those listed are available.



Silicone Rubber Coated Knitted Fiberglass Tape: Non-Adhesive
500°F / 260°C: High Temperature, Heat & Flame Resistant Industrial Tape & Wrap



- FlameShield™ Industrial Tape & Wrap, available in 1” width increments up to 5 inches, is made from a knitted base material. This tape has an approximate 5% elongation capability in the lengthwise direction and 15% in the width wise direction, making for easy installations due to its self compressive characteristic when slightly stretched during wrapping. Tape is 0.142” / 3.6mm thick nominal.
- A Heavy Duty version Tape & Wrap (part number AB-FTHD), available in widths from ½” through 40” wide, is made from our heaviest grade 98 oz/yd² woven material. Due to the base material being woven instead of knitted, the FTHD tape has negligible elongation capability in all directions.
- Also an excellent cold temperature tape with flexibility to -76°C for refrigeration and cryogenic applications.

500°F / 260°C continuous rating with weld splatter / molten metal splash protection.
 2200°F / 1205°C for periods up to 15 minutes and short excursions to 3000°F / 1650°C.

FlameShield™ High Temperature Silicone Rubber Coated Fiberglass Industrial Tape & Wrap – Non Adhesive					
Part Number	Tape Width inch / mm		Price per Roll	Price per Foot	Price per Metre
T-FG-SR-1.00-M025-X	1	25	\$ 237.00	\$ 4.74	\$ 15.49
T-FG-SR-2.00-M051-X	2	51	\$ 391.00	\$ 7.82	\$ 25.57
T-FG-SR-3.00-M076-X	3	76	\$ 491.00	\$ 9.82	\$ 32.11
T-FG-SR-4.00-M102-X	4	102	\$ 649.00	\$ 12.98	\$ 42.57
T-FG-SR-5.00-M127-X	5	127	\$ 798.00	\$ 15.87	\$ 52.05

For the “X” value, use “R” for Full Spool, use “F” for By-The-Foot

1”, 2” and 3” wide tape is available By-The-Foot

Standard length is 100 Feet / 30 Metres, rolled

High Temperature Tape & Wrap is typically used to wrap hydraulic hoses, lines, cables and wiring when a sleeve cannot be installed. The base fabric is a knitted fibreglass, and provides the tape with a small amount of elongation or stretch capability; which allows the over-wrap to hold tight onto what is being wrapped due to the compression that exists when stretched. Band clamps, wire ties or other fasteners can be used to secure the tape if necessary along the wrapped length or at the end of the wrap. An alternative to using Tape is Sleeve with VC, which is a sleeve with Velcro closure.

To aid in mounting this tape onto surfaces, FlangeStik™ pressure sensitive adhesive spray can be used to place the tape in situ temporarily. Permanent fasteners or grab strips should be installed prior to heating of the area sprayed above 200°F. The adhesive will “smoke-off” at elevated temperatures.



Silicone Rubber Coated Woven Fiberglass Tape: Heavy Duty Woven Non-Adhesive 500°F / 260°C: High Temperature, Heat & Flame Resistant Heavy Duty Tape & Wrap



Heavy Duty Tape & Wrap, from ½” through 40” wide is made from our heaviest grade 98 oz/yd² material.

This tape is made from a heavy woven base fabric, which provides for very little elongation capability. This tape is stiffer than the T-FG-SR series tapes. This tape may have edge fray as it is produced by slitting a roll fabric material.

This tape can also be layered and stitched with either face on each side for use as a flange gasket. Multiply price by 2.5 times for 2 layer tape.

FlameShield™ High Temperature Silicone Rubber Coated Fiberglass Heavy Duty Tape & Wrap

Part Number	Width inch / mm / -dash	Price per foot	Price per Metre
T-FGHD-SRHD-0.50-M013	½ / 13 / -08	\$ 2.27	\$ 7.45
T-FGHD-SRHD-0.75-M019	¾ / 19 / -12	\$ 2.77	\$ 9.09
T-FGHD-SRHD-1.00-M025	1 / 25 / -16	\$ 3.37	\$ 11.05
T-FGHD-SRHD-1.25-M032	1 ¼ / 32 / -20	\$ 3.89	\$ 12.76
T-FGHD-SRHD-1.50-M038	1 ½ / 38 / -24	\$ 4.42	\$ 14.50
T-FGHD-SRHD-1.75-M044	1 ¾ / 44 / -28	\$ 4.81	\$ 15.78
T-FGHD-SRHD-2.00-M051	2 / 51 / -32	\$ 5.01	\$ 16.43
T-FGHD-SRHD-2.25-M057	2 ¼ / 57 / -36	\$ 5.58	\$ 18.30
T-FGHD-SRHD-2.50-M064	2 ½ / 64 / -40	\$ 6.13	\$ 20.11
T-FGHD-SRHD-2.75-M070	2 ¾ / 70 / -44	\$ 6.67	\$ 21.88
T-FGHD-SRHD-3.00-M076	3 / 76 / -48	\$ 6.91	\$ 22.66
T-FGHD-SRHD-3.25-M083	3 ¼ / 83 / -52	\$ 7.81	\$ 25.62
T-FGHD-SRHD-3.50-M089	3 ½ / 89 / -56	\$ 8.68	\$ 28.47
T-FGHD-SRHD-3.75-M095	3 ¾ / 95 / -60	\$ 9.44	\$ 30.96
T-FGHD-SRHD-4.00-M102	4 / 102 / -64	\$ 10.01	\$ 32.83
T-FGHD-SRHD-4.25-M108	4 ¼ / 108 / -68	\$ 10.61	\$ 34.80
T-FGHD-SRHD-4.50-M114	4 ½ / 114 / -72	\$ 11.37	\$ 37.30
T-FGHD-SRHD-4.75-M121	4 ¾ / 121 / -76	\$ 11.97	\$ 39.26
T-FGHD-SRHD-5.00-M127	5 / 127 / -80	\$ 12.84	\$ 42.12
T-FGHD-SRHD-5.25-M133	5 ¼ / 133 / -84	\$ 13.79	\$ 45.23
T-FGHD-SRHD-5.50-M140	5 ½ / 140 / -88	\$ 14.71	\$ 48.25
T-FGHD-SRHD-5.75-M146	5 ¾ / 146 / -92	\$ 15.65	\$ 51.33
T-FGHD-SRHD-6.00-M152	6 / 152 / -96	\$ 16.58	\$ 54.38
T-FGHD-SRHD-6.25-M159	6 ¼ / 159 / -100	\$ 17.47	\$ 57.30
T-FGHD-SRHD-6.50-M165	6 ½ / 165 / -104	\$ 18.39	\$ 60.32
T-FGHD-SRHD-6.75-M171	6 ¾ / 171 / -108	\$ 19.27	\$ 63.21
T-FGHD-SRHD-7.00-M178	7 / 178 / -112	\$ 20.18	\$ 66.19
T-FGHD-SRHD-7.25-M184	7 ¼ / 184 / -116	\$ 21.09	\$ 69.18
T-FGHD-SRHD-7.50-M191	7 ½ / 191 / -120	\$ 22.02	\$ 72.23
T-FGHD-SRHD-7.75-M197	7 ¾ / 197 / -124	\$ 22.98	\$ 75.37
T-FGHD-SRHD-8.00-M203	8 / 203 / -128	\$ 23.87	\$ 78.29
T-FGHD-SRHD-8.25-M210	8 ¼ / 210 / -132	\$ 24.84	\$ 81.48
T-FGHD-SRHD-8.50-M216	8 ½ / 216 / -136	\$ 25.78	\$ 84.56
T-FGHD-SRHD-8.75-M222	8 ¾ / 222 / -140	\$ 26.81	\$ 87.94
T-FGHD-SRHD-9.00-M229	9 / 229 / -144	\$ 27.85	\$ 91.35
T-FGHD-SRHD-9.25-M235	9 ¼ / 235 / -148	\$ 28.47	\$ 93.38
T-FGHD-SRHD-9.50-M241	9 ½ / 241 / -152	\$ 28.94	\$ 94.92
T-FGHD-SRHD-9.75-M248	9 ¾ / 248 / -156	\$ 29.53	\$ 96.86
T-FGHD-SRHD-10.00-M254	10 / 254 / -160	\$ 30.03	\$ 98.50

Add “-C4” for double layer stitched (approx .27”) thick

Tape is nominal 0.1350” / 3.4mm thick nominal single layer.

This product is available By-The-Foot. For sizes larger than 10” wide please call for a quote

500°F / 260°C continuous rating with weld splatter / molten metal splash protection.

To aid in mounting this tape onto surfaces, FlangeStik™ pressure sensitive adhesive spray can be used to place the tape in situ temporarily. Permanent fasteners or grab strips should be installed prior to heating of the area sprayed above 200°F. The adhesive will “smoke-off” at elevated temperatures.



Two-Side Silicone Rubber Coated Fiberglass Slit Tape & Wrap, Non-Adhesive, Weld Splatter Protection

500°F / 260°C: High Temperature, Heat & Flame Resistant

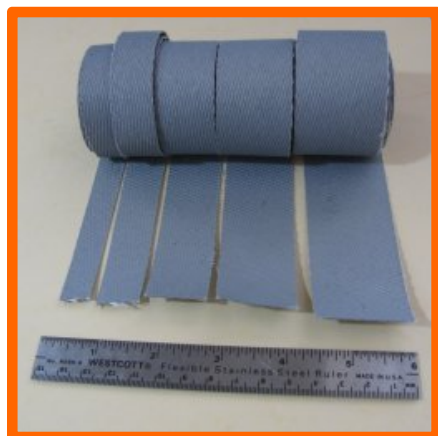

This tape is made from silicone rubber coated fabric; and is typically used as a gasket material or to wrap hydraulic hoses, lines, cables and wiring when a sleeve cannot be installed. The tape has an internal woven fiberglass fabric base which allows only a very minimal amount of bias elongation and negligible elongation along its width and length. (1-side coated tapes such as part number T-FG-SR provide higher elongation).

Tape thicknesses A is made by slitting the fabric roll, while thicknesses B and C are made by layering and stitching. Also an excellent cold temperature tape with flexibility to -76°C for refrigeration and cryogenic applications.

The edges of this tape can be sealed with our liquid silicone SleeveSeal™. This tape makes an excellent weatherproofing when sealed with SleeveSeal™ Tape or Dip or Paste.

500°F / 260°C continuous rating with weld splatter / molten metal splash protection

FlameShield™ High Temperature Two-Side Silicone Rubber Coated Fiberglass Tape & Wrap					
Part Number	Width in / mm		Price per Foot / Metre by Thickness: A / B / C		
			A	B	C
			1/16" / 1.59mm	1/8" / 3.18mm	1/4" / 6.35mm
T-FG-SR-S2-M025-16-X	1.0	25	\$ 1.92 / \$ 6.30	\$ 3.84 / \$ 12.60	\$ 7.68 / \$ 25.19
T-FG-SR-S2-M032-20-X	1.25	32	\$ 2.40 / \$ 7.87	\$ 4.80 / \$ 15.74	\$ 9.60 / \$ 31.49
T-FG-SR-S2-M038-24-X	1.5	38	\$ 2.88 / \$ 9.45	\$ 5.76 / \$ 18.89	\$ 11.52 / \$ 37.79
T-FG-SR-S2-M051-32-X	2.0	51	\$ 3.84 / \$ 12.60	\$ 7.68 / \$ 25.19	\$ 15.36 / \$ 50.38
T-FG-SR-S2-M064-40-X	2.5	64	\$ 4.80 / \$ 15.74	\$ 9.60 / \$ 31.49	\$ 19.20 / \$ 62.98
T-FG-SR-S2-M076-48-X	3.0	76	\$ 5.76 / \$ 18.89	\$ 11.52 / \$ 37.79	\$ 23.04 / \$ 75.57
T-FG-SR-S2-M089-56-X	3.5	89	\$ 6.72 / \$ 22.04	\$ 13.44 / \$ 44.08	\$ 26.88 / \$ 88.17
T-FG-SR-S2-M102-64-X	4.0	102	\$ 7.68 / \$ 25.19	\$ 15.36 / \$ 50.38	\$ 30.72 / \$ 100.76
T-FG-SR-S2-M127-80-X	5.0	127	\$ 9.60 / \$ 31.49	\$ 19.20 / \$ 62.98	\$ 38.40 / \$ 125.95
T-FG-SR-S2-M152-96-X	6.0	152	\$ 11.52 / \$ 37.79	\$ 23.04 / \$ 75.57	\$ 46.08 / \$ 151.14
T-FG-SR-S2-M178-112-X	7.0	178	\$ 13.44 / \$ 44.08	\$ 26.88 / \$ 88.17	\$ 53.76 / \$ 176.33
T-FG-SR-S2-M203-128-X	8.0	203	\$ 15.36 / \$ 50.38	\$ 30.72 / \$ 100.76	\$ 61.44 / \$ 201.52
T-FG-SR-S2-M254-160-X	10.0	254	\$ 19.20 / \$ 62.98	\$ 38.40 / \$ 125.95	\$ 76.88 / \$ 252.17
T-FG-SR-S2-M305-192-X	12.0	305	\$ 23.04 / \$ 75.57	\$ 46.08 / \$ 151.14	\$ 92.16 / \$ 302.29
T-FG-SR-S2-M355-224-X	14.0	355	\$ 26.88 / \$ 88.17	\$ 53.76 / \$ 176.33	\$ 107.52 / \$ 352.67
T-FG-SR-S2-M457-288-X	18.0	457	\$ 34.56 / \$ 113.36	\$ 69.12 / \$ 226.71	\$ 138.24 / \$ 453.43
T-FG-SR-S2-M508-320-X	20.0	508	\$ 38.40 / \$ 125.95	\$ 76.80 / \$ 251.91	\$ 153.60 / \$ 503.81

- For the "X" value, specify A, B or C in part number to correspond to the desired thickness
 A1 = 1/16" / .0625" / 1.59mm B2 = 1/8" / .125" / 3.18mm C4 = 1/4" / .250" / 6.35mm

Band clamps, wire ties or other fasteners can be used to secure the tape if necessary along the wrapped length or at the end of the wrap. An alternative to using this tape is to use sleeve with Velcro closure. For gasket applications, this tape can usually be secured with a silicone adhesive such as our AB-HTG-165 (general purpose high temperature silicone adhesive) or AB-SRB-201 (specialty adhesive for bonding silicone rubber components together). For larger sizes than 12" please call for a quote

To aid in mounting this tape onto surfaces, FlangeStik™ pressure sensitive adhesive spray can be used to place the tape in situ temporarily. Permanent fasteners or grab strips should be installed prior to heating of the area sprayed above 200°F. The adhesive will "smoke-off" at elevated temperatures.

Silicone Rubber Coated Fiberglass Reinforced Tape Premium Grade (No Adhesive)

-100°F to 450°F / -73°C to 232°C: High Temperature Heat & Chemical Resistance
 DeltaGlass™

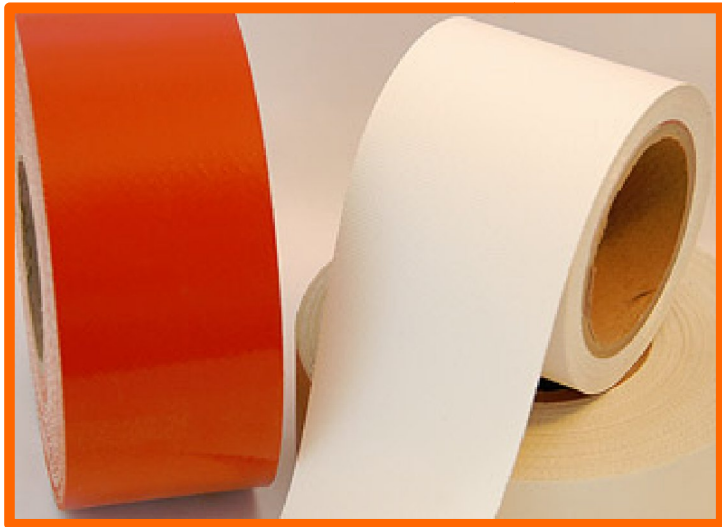

- e-fiberglass core.
- Silicone rubber coating.
- Excellent release properties.
- High dielectric factor.

This fabric offers high temperature range with excellent resistance to almost all solvents, caustics and acids. Non-porous finish. Welding splatter, spark and molten splash resistant.

The base fabric is rated to 1200°F / 648°C.

Used as gaskets, safety curtains, conveyor belts. Used to wrap other insulation materials on piping to provide contamination protection.

Any Width Is Available Between 1/2" and 36 inches

450°F / 232°C continuous rating, high insulation value & excellent personnel protection

High Temperature, Heat & Chemical Resistance DeltaGlass™ E-glass Fiberglass Tape with Silicone Rubber Coating – Premium Grade

Part Number	Thickness, in.	Tensile warp lbs/in	Weight oz/yd ²	Price per Inch of Roll Width (Roll Length: 18 yd / 36 yd)
T-FG-SR2-P-009339-10-W	.0093	74	10	\$ 38.35 / \$ 76.70
T-FG-SR2-P-015039-16-R/W	.0150	229	16	\$ 34.93 / \$ 69.85
T-FG-SR2-P-020339-22-R	.0203	263	22	\$ 36.10 / \$ 72.20
T-FG-SR2-P-022039-22-R/W	.0220	285	22	\$ 54.08 / \$ 108.15
T-FG-SR1-P-023037.5-24-R*	.0230	350	24	\$ 51.09 / \$ 102.17
T-FG-SR2-P-029539-32-R	.0295	286	32	\$ 65.47 / \$ 130.93
T-FG-SR2-P-040039-41-W	.0400	410	41	\$ 68.87 / \$ 137.73

- * This tape is coated with a saturation process that leave the reverse side fabric sealed but with no extra coverage over the base fabric that the other versions have.
- W at the end of the part number indicates white color. R indicates red color.

MIL Spec MIL-I-46852 / A-A-59163 Silicone Rubber Self Fusing Compression & Stretch Electrical Insulating Tape

500°F / 260°C: FlameShield™ Self Binding / Self-Fusing / Self Amalgamating Tape -
High Temperature, Heat & Flame Resistant



- Self-bonds / self fuses / self amalgamating tape. No residue when removed. Starts fusing within minutes; fully bonded within hours. Excellent cold temperature performance. Low water absorption.
- Tested to:
 - ASTM D 149; provides minimum 400 V/mil. for .010" to .030" thick tape, 300 V/mil for .040" thick tape and 250 V/mil for .060" thick tape.
 - ASTM D 412; provides minimum 700 psi tensile strength and minimum 300% elongation.
 - ASTM D 2240; Durometer (Shore A); 55. Other test data available.
- Excellent for sealing ends of firesleeve: prevents sleeve from absorbing contamination and wicking liquids. Excellent for wrapping electrical & mechanical connections and splices. Makes clean and neat installations of cables, wires and hoses. Makes an instant separation bumper and provides vibration dampening.
- Meets Mil-I-46852, AA59163 and ABS 5334 specifications. Certificate of Conformity available.
- Cross Reference Equivalents Available to MOX 600R and 600T levelwrap series; 602-1, 603-1, 604-1, 605-1, 606-1, 607-1. McDonnell Douglas / Boeing DMS-2186 Type I & II, McDonnell Douglas Helicopter HS5215, General Dynamics P5384, Martin Marietta MMS 517-6 Type II, McDonnell Douglas P.S. 17115, ST0130RB0078 Type I, 3003M70P01, MS70T09-S, WS1363A, Premier Farnell 810112, Safe Flight 59562-5, PLYSIL3455, TYT200-1, 66N, 67N and various NATO / National Stock Numbers (NSN).
- Standard roll length is 36 feet / 12 Yards / 10.9 Metres; other lengths available.
- Amalgamating time: Room temperature; 24 hours / at 120°C; 120 minutes / at 150°C; 35 minutes / at 200°C; 20 minutes / at 250°C; 15 minutes. Tested for short duration fluid resistance: Jet Fuel (JP5), Hydraulic Fluid (Skydrol 500B4), Mineral Oil (NATO 0142), Synthetic Oil (NATO 0156), MIL-C-87836 & Foran 141B cleaning fluids, MIL-A-8243 cooling fluid.

These tapes are guaranteed to meet specification for 1 year from date of manufacture providing tapes are stored dry at 21°C +/- 3°C or 70°F +/- 5°F. Standard tapes have an interleaved liner of polyethylene. Polyester liner available.

Type II tapes have a center guideline stripe to assist in making 50% overwraps. The triangular profile version tape allows for minimal ridge lines, providing wire and cable splices and joints with an almost totally smooth surface (prevents snagging when splice is pulled through obstructions).

FlameShield™ MIL Spec High Temperature Silicone Self Fusing Compression/Stretch Electrical Insulating Tape Meets MIL-I-46852 / A-A-59163 / ABS 5334 Specifications - Type I and Type II				
Part Number	Tape Width Inches / mm	Thickness inches / mm	Color / Type / Profile	Single Roll Price Per Roll
T-SR-M013-08-RBK-20	1/2 / 12.7	0.020 / 0.508	Black / I / Rectangular	\$ 29.37
T-SR-M013-08-RXX-30	1/2 / 12.7	0.030 / 0.760	Black or Red / I / Rectangular	\$ 37.16
T-SR-M016-10-RBK-20	5/8 / 15.7	0.020 / 0.508	Black / I / Rectangular	\$ 30.17
T-SR-M019-12-RBK-20	3/4 / 19	0.020 / 0.508	Black / I / Rectangular	\$ 31.96
T-SR-M025-16-RXX-10	1 / 25.4	0.010 / 0.250	Black or Red / I / Rectangular	\$ 29.37
T-SR-M025-16-TXX-20	1 / 25.4	0.020 / 0.508	Black or Red / II / Triangular	\$ 33.80
T-SR-M025-16-RXX-20	1 / 25.4	0.020 / 0.508	Black or Red / I / Rectangular	\$ 34.71
T-SR-M025-16-TXX-40	1 / 25.4	0.040 / 1.000	Black or Red / II / Triangular	\$ 37.91
T-SR-M025-16-RXX-40	1 / 25.4	0.040 / 1.000	Black or Red / I / Rectangular	\$ 39.64
T-SR-M038-24-RXX-20	1 1/2 / 38.1	0.020 / 0.508	Black or Red / I / Rectangular	\$ 48.77
T-SR-M038-24-RXX-12	1 1/2 / 38.1	0.012 / 0.304	Black or Red / I / Rectangular	\$ 38.47
T-SR-M051-32-RXX-20	2 / 50.8	0.020 / 0.508	Black or Red / I / Rectangular	\$ 57.13
T-SR-M051-32-TXX-20	2 / 50.8	0.020 / 0.508	Black or Red / II / Triangular	\$ 48.86
Triangular Type II Tapes Only: .020" has a blue guideline / .040" has a green guideline				

Please enquire for pricing on widths and thicknesses other than those listed above.

- Standard roll length is 36 feet / 12 Yards / 10.9 Metres; other lengths available.
- For the XX value in the part number (color code): OR = Oxide-Red, BK = Black. Other colors available.
- Certificate of Conformity: Add \$6.00 for individual roll CoFC. Lot/Batch CoFC \$25.00 per order line item.
- Test Report: Add \$75.00 per order line item.

Amalgamating time: Room temperature; 24 hours / at 120°C; 120 minutes / at 150°C; 35 minutes / at 200°C; 20 minutes / at 250°C; 15 minutes. Tested for short duration fluid resistance: Jet Fuel (JP5), Hydraulic Fluid (Skydrol 500B4), Mineral Oil (NATO 0142), Synthetic Oil (NATO 0156), MIL-C-87836 & Foran 141B cleaning fluids, MIL-A-8243 cooling fluid.

These tapes are guaranteed to meet specification for 1 year from date of manufacture providing tapes are stored dry at 21°C +/- 3°C or 70°F +/- 5°F. Standard tapes have an interleaved liner of polyethylene. Polyester liner available.

Type II tapes have a center guideline stripe to assist in making 50% overwraps. The triangular profile version tape allows for minimal ridge lines, providing wire and cable splices and joints with an almost totally smooth surface (prevents snagging when splice is pulled through obstructions).

FlameShield™ MIL Spec Silicone Rubber Self Fusing Compression & Stretch Electrical Insulating Tape - Technical Data

Specifications for FlameShield™ Silicone Rubber Tape (MIL-I-46852 & A-A-59163) Class 1 – Type I and Type II			
Property	Standard	Nominal Test Result or Tolerance	Test Method
Thickness: 1" wide tape 1.5" wide tape 2.0" wide tape	.010" .020" .030" .040" .020" .020"	+/- .002"	N/A
Width	0.50", 0.75", 1.00", 1.50", 2.00"	+/- .020"	N/A
Length	36 feet / 12 yards / 10.9m	+/- 6.00"	N/A
Color	Oxide-Red or Black	N/A	N/A
Guideline Color (Type II)	.020" Tapes: Blue .030" Tapes: White .040" Tapes: Green	N/A	N/A
Operating Temperature	-60°C to +260°C -76°C to +500°F	N/A	N/A
Brittle Temperature	-65°C / -85°F	N/A	N/A
Interleave Material	.002" thick Mylar	N/A	N/A
Tensile Strength	700 psi (minimum)	1100	ASTM D412 / D119
Dielectric Strength	.020" Tape: 400 V/mm .030" Tape: 400 V/mm .040" Tape: 300 V/mm	575	ASTM D-149
Dielectric Constant		2.94 @ 1Khz	ASTM D150
Volume Resistivity	1×10^{14} ohms/cm ³	3×10^{14}	ASTM D149
Elongation	300% (minimum)	700	ASTM D412 / D119
Tear Strength	85 psi (minimum)	146	ASTM D624
Bond Strength (1" Width)	2 lbs (minimum)	5.5	ASTM D2148
Adhesion	Shall not unwind more than 1.0" after 3 minutes with 600g load	0.12"	ASTM D2148
Inclined Mandrel Tack Test (inch)		0.25	ASTM D2148
Water absorption (by wt)	3% Maximum	0.9%	FED-STD-601 Method 6251
Dissipation Factor		<0.0004 @ 1 KHz	ASTM D150
Hardness, durometer Shore A	55 - 65	55	ASTM D2148 / D2240
Flame Test		Pass	FAA 60 Sec Vertical



MIL-I-46852-1I0010 / MIL-I-46852-1I0020 / MIL-I-46852-1I0030

MIL-I-46852-1I0040

Class 1 - Type I

MIL-I-46852-1II0020 / MIL-I-46852-1II0030 / MIL-I-46852-1II0040

Class 1 - Type II

Silicone Rubber Self Fusing Electrical Insulating Tape

500°F / 260°C: FlameShield™ Self Binding / Self-Fusing / Self Amalgamating Tape - High Temperature, Heat & Flame Resistant

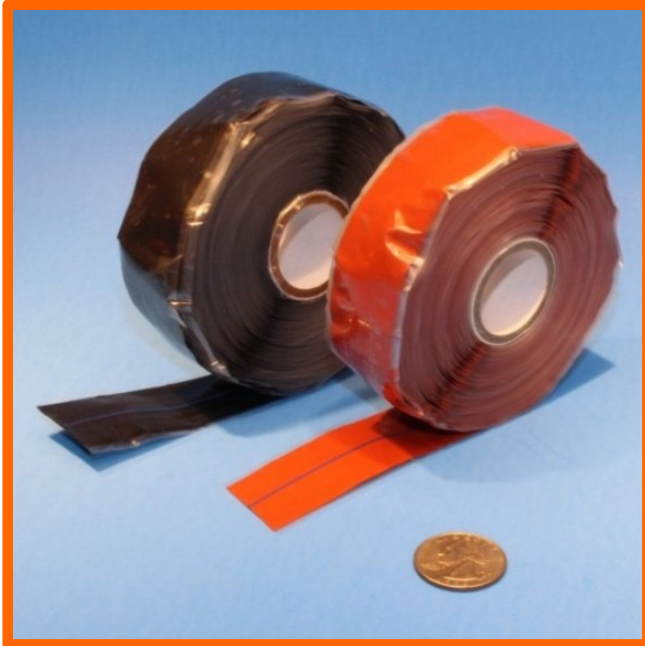

- Self-bonds / self fuses / self amalgamating tape. No residue when removed. Starts fusing within minutes; fully bonded within hours. Excellent cold temperature performance. Low water absorption.
- Tested to:
 - ASTM D 149; provides minimum 400 V/mil. for .010" to .030" thick tape, 300 V/mil for .040" thick tape and 250 V/mil for .060" thick tape.
 - ASTM D 412; provides minimum 700 psi tensile strength and minimum 300% elongation.
 - ASTM D 2240; Durometer (Shore A); 55. Other test data available.
- Excellent for sealing ends of firesleeve: prevents sleeve from absorbing contamination and wicking liquids. Excellent for wrapping electrical & mechanical connections and splices. Makes clean and neat installations of cables, wires and hoses. Makes an instant separation bumper and provides vibration dampening.
- Meets Mil-I-46852, AA59163 and ABS 5334 specifications. Certificate of Conformity available.
- Cross Reference Equivalents Available to MOX 600R and 600T levelwrap series; 602-1, 603-1, 604-1, 605-1, 606-1, 607-1. McDonnell Douglas / Boeing DMS-2186 Type I & II, McDonnell Douglas Helicopter HS5215, General Dynamics P5384, Martin Marietta MMS 517-6 Type II, McDonnell Douglas P.S. 17115, ST0130RB0078 Type I, 3003M70P01, MS70T09-S, WS1363A, Premier Farnell 810112, Safe Flight 59562-5, PLYSIL3455, TYT200-1, 66N, 67N and various NATO / National Stock Numbers (NSN).
- Amalgamating time: Room temperature; 24 hours / at 120°C; 120 minutes / at 150°C; 35 minutes / at 200°C; 20 minutes / at 250°C; 15 minutes. Tested for short duration fluid resistance: Jet Fuel (JP5), Hydraulic Fluid (Skydrol 500B4), Mineral Oil (NATO 0142), Synthetic Oil (NATO 0156), MIL-C-87836 & Foran 141B cleaning fluids, MIL-A-8243 cooling fluid.

These tapes are guaranteed to meet specification for 1 year from date of manufacture providing tapes are stored dry at 21°C +/- 3°C or 70°F +/- 5°F. Standard tapes have an interleaved liner of polyethylene. Polyester liner available.

Type II tapes have a center guideline stripe to assist in making 50% overwraps. The triangular profile version tape allows for minimal ridge lines, providing wire and cable splices and joints with an almost totally smooth surface (prevents snagging when splice is pulled through obstructions).

FlameShield™ MIL-I-46852 Specification
High Temperature Silicone Self Fusing
Compression/Stretch Electrical Insulating Tape

MIL-I-46852-1I0020 / MIL-I-46852-1II0020 / MIL-I-46852-1I0030 / MIL-I-46852-1II0030
MIL-I-46852-1I0040 / MIL-I-46852-1II0040

Class 1 – Type I and Class 1 - Type II

Part Number	Tape Width Inches	Thickness inches	Color / Type / Profile	Price Per Roll
MIL-I-46852-1I0020-RBK-0.50	½"	0.020"	Black / Type I / Rectangular	\$ 29.37
MIL-I-46852-1I0030-RXX-0.50	½"	0.030"	Black or Red / Type I / Rectangular	\$ 37.16
MIL-I-46852-1I0020-RBK-0.62	5/8"	0.020"	Black / Type I / Rectangular	\$ 30.17
MIL-I-46852-1I0020-RBK-0.75	¾"	0.020"	Black / Type I / Rectangular	\$ 31.96
MIL-I-46852-1I0010-RXX-1.00	1"	0.010"	Black or Red / Type I / Rectangular	\$ 29.37
MIL-I-46852-1II0020-TXX-1.00	1"	0.020"	Black or Red / Type II / Triangular	\$ 33.80
MIL-I-46852-1I0020-RXX-1.00	1"	0.020"	Black or Red / Type I / Rectangular	\$ 34.71
MIL-I-46852-1II0040-TXX-1.00	1"	0.040"	Black or Red / Type II / Triangular	\$ 37.91
MIL-I-46852-1I0040-RXX-1.00	1"	0.040"	Black or Red / Type I / Rectangular	\$ 39.64
MIL-I-46852-1I0020-RXX-1.50	1 ½"	0.020"	Black or Red / Type I / Rectangular	\$ 48.77
MIL-I-46852-1I0012-RXX-1.50	1 ½"	0.012"	Black or Red / Type I / Rectangular	\$ 38.47
MIL-I-46852-1I0020-RXX-2.00	2"	0.020"	Black or Red / Type I / Rectangular	\$ 57.13
MIL-I-46852-1I0020-TXX-2.00	2"	0.020"	Black or Red / Type II / Triangular	\$ 48.86

Guideline Color on Type II Triangular Tapes Only: .020" = blue / .030" = white / .040" = green

Type II edge thickness is .008" +/- .001"

Please enquire for pricing on widths and thicknesses other than those listed above.

- Standard roll length is 36 feet / 12 Yards / 10.9 Metres; other lengths available.
- For the XX value (color code): OR = Oxide-Red, BK = Black. Other colors available.
- Certificate of Conformity: Add \$6.00 for individual roll CofC. Lot/Batch CofC \$25.00 per order line item.
- Test Report: Add \$75.00 per order line item.

Amalgamating time: Room temperature; 24 hours / at 120°C; 120 minutes / at 150°C; 35 minutes / at 200°C; 20 minutes / at 250°C; 15 minutes. Tested for short duration fluid resistance: Jet Fuel (JP5), Hydraulic Fluid (Skydrol 500B4), Mineral Oil (NATO 0142), Synthetic Oil (NATO 0156), MIL-C-87836 & Foran 141B cleaning fluids, MIL-A-8243 cooling fluid.

These tapes are guaranteed to meet specification for 1 year from date of manufacture providing tapes are stored dry at 21°C +/- 3°C or 70°F +/- 5°F. Standard tapes have an interleaved liner of polyethylene. Polyester liner available.

FlameShield™ MIL-I-46852 Specification Silicone Rubber Self Fusing Electrical Insulating Tape - Technical Data

Specifications for FlameShield™ Silicone Rubber Tape meeting MIL-I-46852 Class 1 – Type I and Type II			
Property	Standard	Nominal Test Result or Tolerance	Test Method
Thickness: 1" wide tape	.010" .020" .030" .040"	+/- .002"	N/A
Width	0.50", 0.625", 0.75", 1.00", 1.50", 2.00"	+/- .020"	N/A
Length	36 feet / 12 yards	+/- 6.00"	N/A
Color	Oxide-Red or Black	N/A	N/A
Guideline Color (Type II)	.020" Tapes: Blue .030" Tapes: White .040" Tapes: Green	N/A	N/A
Operating Temperature	-60°C to +260°C -76°C to +500°F	N/A	N/A
Brittle Temperature	-65°C / -85°F	N/A	N/A
Interleave Material	.002" thick Mylar	N/A	N/A
Tensile Strength	700 psi (minimum)	1100	ASTM D412 / D119
Dielectric Strength	.010" tape: 400 V/mil .020" tape: 400 V/mil .030" tape: 400 V/mil .040" tape: 300 V/mil	575	ASTM D-149
Dielectric Constant		2.94 @ 1Khz	ASTM D150
Volume Resistivity	1×10^{14} ohms/cm ³	3×10^{14}	ASTM D149
Elongation	300% (minimum)	700	ASTM D412 / D119
Tear Strength	85 psi (minimum)	146	ASTM D624
Bond Strength (1" Width)	2 lbs (minimum)	5.5	ASTM D2148
Adhesion	Shall not unwind more than 1.0" after 3 minutes with 600g load	0.12"	ASTM D2148
Inclined Mandrel Tack Test (inch)		0.25	ASTM D2148
Water absorption (by wt)	3% Maximum	0.9%	FED-STD-601 Method 6251
Dissipation Factor		<0.0004 @ 1 Khz	ASTM D150
Hardness, durometer Shore A	55 - 65	55	ASTM D2148 / D2240
Flame Test		Pass	FAA 60 Sec Vertical



AA59163-1I0010 / AA59163-1I0020 / AA59163-1I0030 / AA59163-1I0040

Class 1 - Type I

AA59163-1II0020 / AA59163-1II0030 / AA59163-1II0040

Class 1 - Type II

Silicone Rubber Self Fusing Electrical Insulating Tape

500°F / 260°C: FlameShield™ *Self Binding / Self-Fusing / Self Amalgamating Tape - High Temperature, Heat & Flame Resistant*

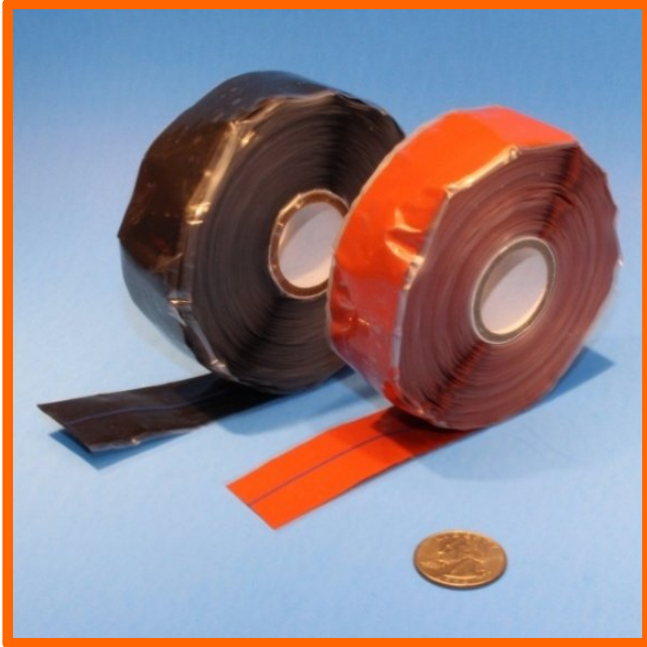

- Self-bonds / self fuses / self amalgamating tape. No residue when removed. Starts fusing within minutes; fully bonded within hours. Excellent cold temperature performance. Low water absorption.
- Tested to:
 - ASTM D 149; provides minimum 400 V/mil. for .010" to .030" thick tape, 300 V/mil for .040" thick tape and 250 V/mil for .060" thick tape.
 - ASTM D 412; provides minimum 700 psi tensile strength and minimum 300% elongation.
 - ASTM D 2240; Durometer (Shore A); 55. Other test data available.
- Excellent for sealing ends of firesleeve: prevents sleeve from absorbing contamination and wicking liquids. Excellent for wrapping electrical & mechanical connections and splices. Makes clean and neat installations of cables, wires and hoses. Makes an instant separation bumper and provides vibration dampening.
- Meets Mil-I-46852, AA59163 and ABS 5334 specifications. Certificate of Conformity available.
- Cross Reference Equivalents Available to MOX 600R and 600T levelwrap series; 602-1, 603-1, 604-1, 605-1, 606-1, 607-1. McDonnell Douglas / Boeing DMS-2186 Type I & II, McDonnell Douglas Helicopter HS5215, General Dynamics P5384, Martin Marietta MMS 517-6 Type II, McDonnell Douglas P.S. 17115, ST0130RB0078 Type I, 3003M70P01, MS70T09-S, WS1363A, Premier Farnell 810112, Safe Flight 59562-5, PLYSIL3455, TYT200-1, 66N, 67N and various NATO / National Stock Numbers (NSN).
- Amalgamating time: Room temperature; 24 hours / at 120°C; 120 minutes / at 150°C; 35 minutes / at 200°C; 20 minutes / at 250°C; 15 minutes. Tested for short duration fluid resistance: Jet Fuel (JP5), Hydraulic Fluid (Skydrol 500B4), Mineral Oil (NATO 0142), Synthetic Oil (NATO 0156), MIL-C-87836 & Foran 141B cleaning fluids, MIL-A-8243 cooling fluid.

These tapes are guaranteed to meet specification for 1 year from date of manufacture providing tapes are stored dry at 21°C +/- 3°C or 70°F +/- 5°F. Standard tapes have an interleaved liner of polyethylene. Polyester liner available.

Type II tapes have a center guideline stripe to assist in making 50% overwraps. The triangular profile version tape allows for minimal ridge lines, providing wire and cable splices and joints with an almost totally smooth surface (prevents snagging when splice is pulled through obstructions).

**FlameShield™ CID AA-59163 Specification
High Temperature Silicone Self Fusing
Compression/Stretch Electrical Insulating Tape**

**AA59163-1I0020 / AA59163-1II0020 / AA59163-1I0030 / AA59163-1II0030
AA59163-1I0040 / AA59163-1II0040**

Class 1 – Type I and Class 1 - Type II

Part Number	Tape Width Inches	Thickness inches	Color / Type / Profile	Single Roll Price Per Roll
AA59163-1I0020-RBK-0.50	½"	0.020"	Black / Type I / Rectangular	\$ 29.37
AA59163-1I0030-RXX-0.50	½"	0.030"	Black or Red / Type I / Rectangular	\$ 37.16
AA59163-1I0020-RBK-0.62	5/8"	0.020"	Black / Type I / Rectangular	\$ 30.17
AA59163-1I0020-RBK-0.75	¾"	0.020"	Black / Type I / Rectangular	\$ 31.96
AA59163-1I0010-RXX-1.00	1"	0.010"	Black or Red / Type I / Rectangular	\$ 29.37
AA59163-1II0020-TXX-1.00	1"	0.020"	Black or Red / Type II / Triangular	\$ 33.80
AA59163-1I0020-RXX-1.00	1"	0.020"	Black or Red / Type I / Rectangular	\$ 34.71
AA59163-1II0040-TXX-1.00	1"	0.040"	Black or Red / Type II / Triangular	\$ 37.91
AA59163-1I0040-RXX-1.00	1"	0.040"	Black or Red / Type I / Rectangular	\$ 39.64
AA59163-1I0020-RXX-1.50	1 ½"	0.020"	Black or Red / Type I / Rectangular	\$ 48.77
AA59163-1I0012-RXX-1.50	1 ½"	0.012"	Black or Red / Type I / Rectangular	\$ 38.47
AA59163-1I0020-RXX-2.00	2"	0.020"	Black or Red / Type I / Rectangular	\$ 57.13
AA59163-1I0020-TXX-2.00	2"	0.020"	Black or Red / Type II / Triangular	\$ 48.86

Guideline Color on Type II Triangular Tapes Only: .020" = blue / .030" = white / .040" = green

Type II edge thickness is .008" +/- .001"

Please enquire for pricing on widths and thicknesses other than those listed above.

- Standard roll length is 36 feet / 12 Yards / 10.9 Metres; other lengths available.
- For the XX value (color code): OR = Oxide-Red, BK = Black. Other colors available.
- Certificate of Conformity: Add \$6.00 for individual roll CofC. Lot/Batch CofC \$25.00 per order line item.
- Test Report: Add \$75.00 per order line item.

Amalgamating time: Room temperature; 24 hours / at 120°C; 120 minutes / at 150°C; 35 minutes / at 200°C; 20 minutes / at 250°C; 15 minutes. Tested for short duration fluid resistance: Jet Fuel (JP5), Hydraulic Fluid (Skydrol 500B4), Mineral Oil (NATO 0142), Synthetic Oil (NATO 0156), MIL-C-87836 & Foran 141B cleaning fluids, MIL-A-8243 cooling fluid.

These tapes are guaranteed to meet specification for 1 year from date of manufacture providing tapes are stored dry at 21°C +/- 3°C or 70°F +/- 5°F. Standard tapes have an interleaved liner of polyethylene. Polyester liner available.

FlameShield™ CID AA-59163 Specification Silicone Rubber Self Fusing Electrical Insulating Tape - Technical Data

Specifications for FlameShield™ Silicone Rubber Tape (MIL-I-46852 & A-A-59163) Class 1 – Type I and Type II			
Property	Standard	Nominal Test Result or Tolerance	Test Method
Thickness: 1" wide tape	.010" .020" .030" .040"	+/- .002"	N/A
Width	0.50", 0.625", 0.75", 1.00", 1.50", 2.00"	+/- .020"	N/A
Length	36 feet / 12 yards	+/- 6.00"	N/A
Color	Oxide-Red or Black	N/A	N/A
Guideline Color (Type II)	.020" Tapes: Blue .030" Tapes: White .040" Tapes: Green	N/A	N/A
Operating Temperature	-60°C to +260°C -76°C to +500°F	N/A	N/A
Brittle Temperature	-65°C / -85°F	N/A	N/A
Interleave Material	.002" thick Mylar	N/A	N/A
Tensile Strength	700 psi (minimum)	1100	ASTM D412 / D119
Dielectric Strength	.010" tape: 400 V/mil .020" tape: 400 V/mil .030" tape: 400 V/mil .040" tape: 300 V/mil	575	ASTM D-149
Dielectric Constant		2.94 @ 1Khz	ASTM D150
Volume Resistivity	1 x 10 ¹⁴ ohms/cm ³	3 x 10 ¹⁴	ASTM D149
Elongation	300% (minimum)	700	ASTM D412 / D119
Tear Strength	85 psi (minimum)	146	ASTM D624
Bond Strength (1" Width)	2 lbs (minimum)	5.5	ASTM D2148
Adhesion	Shall not unwind more than 1.0" after 3 minutes with 600g load	0.12"	ASTM D2148
Inclined Mandrel Tack Test (inch)		0.25	ASTM D2148
Water absorption (by wt)	3% Maximum	0.9%	FED-STD-601 Method 6251
Dissipation Factor		<0.0004 @ 1 Khz	ASTM D150
Hardness, durometer Shore A	55 - 65	55	ASTM D2148 / D2240
Flame Test		Pass	FAA 60 Sec Vertical



**AA59163-1I0010 / AA59163-1I0020 / AA59163-1II0020 / AA59163-1I0030
AA59163-1II0030 / AA59163-1I0040 / AA59163-1II0040
Class 2 - Type IM and Class2 - Type IIM
Silicone Rubber Self Fusing Electrical Insulating Tape**

**500°F / 260°C: FlameShield™ Self Binding / Self-Fusing / Self Amalgamating Tape -
High Temperature, Heat & Flame Resistant**

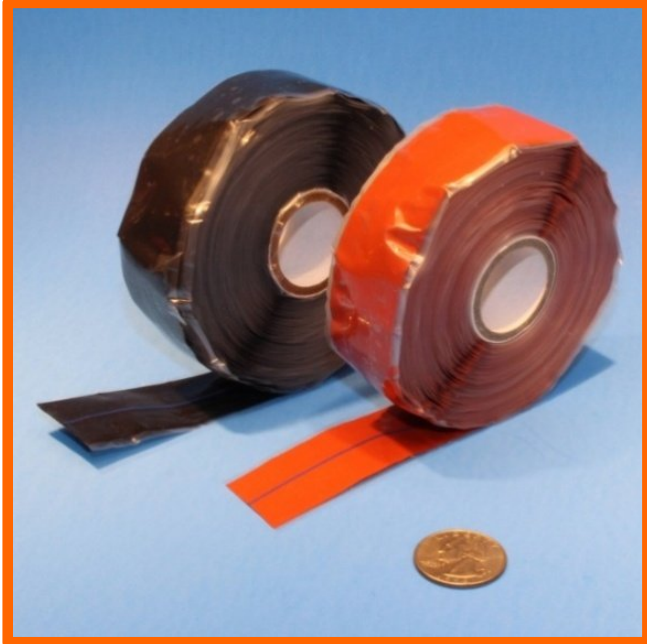

- Self-bonds / self fuses / self amalgamating tape. No residue when removed. Starts fusing within minutes; fully bonded within hours. Excellent cold temperature performance. Low water absorption.
- Tested to:
 - ASTM D 149; provides minimum 400 V/mil. for 0.250mm to 0.750mm thick tape, 300 V/mil for 1.000mm thick tape.
 - ASTM D 412; provides minimum 4800 kPa tensile strength and minimum 300% elongation.
 - ASTM D 2240; Durometer (Shore A); 55. Other test data available.
- Excellent for sealing ends of firesleeve: prevents sleeve from absorbing contamination and wicking liquids. Excellent for wrapping electrical & mechanical connections and splices. Makes clean and neat installations of cables, wires and hoses. Makes an instant separation bumper and provides vibration dampening.
- Meets Mil-I-46852, AA59163 and ABS 5334 specifications. Certificate of Conformity available.
- Cross Reference Equivalents Available to MOX 600R and 600T levelwrap series; 602-1, 603-1, 604-1, 605-1, 606-1, 607-1. McDonnell Douglas / Boeing DMS-2186 Type I & II, McDonnell Douglas Helicopter HS5215, General Dynamics P5384, Martin Marietta MMS 517-6 Type II, McDonnell Douglas P.S. 17115, ST0130RB0078 Type I, 3003M70P01, MS70T09-S, WS1363A, Premier Farnell 810112, Safe Flight 59562-5, PLYSIL3455, TYT200-1, 66N, 67N and various NATO / National Stock Numbers (NSN).
- Amalgamating time: Room temperature; 24 hours / at 120°C; 120 minutes / at 150°C; 35 minutes / at 200°C; 20 minutes / at 250°C; 15 minutes. Tested for short duration fluid resistance: Jet Fuel (JP5), Hydraulic Fluid (Skydrol 500B4), Mineral Oil (NATO 0142), Synthetic Oil (NATO 0156), MIL-C-87836 & Foran 141B cleaning fluids, MIL-A-8243 cooling fluid.

These tapes are guaranteed to meet specification for 1 year from date of manufacture providing tapes are stored dry at 21°C +/- 3°C or 70°F +/- 5°F. Standard tapes have an interleaved liner of polyethylene. Polyester liner available.

Type II tapes have a center guideline stripe to assist in making 50% overwraps. The triangular profile version tape allows for minimal ridge lines, providing wire and cable splices and joints with an almost totally smooth surface (prevents snagging when splice is pulled through obstructions).

**FlameShield™ CID AA-59163 Specification
High Temperature Silicone Self Fusing
Compression/Stretch Electrical Insulating Tape**

**AA59163-1I0020 / AA59163-1II0020 / AA59163-1I0030 / AA59163-1II0030
AA59163-1I0040 / AA59163-1II0040**

Class 2 – Type IM and Class 2 - Type IIM

Part Number	Tape Width mm	Thickness mm	Color / Type / Profile	Single Roll Price Per Roll
AA59163-2IM0500-RBK-13	13	0.500	Black / Type IM / Rectangular	\$ 29.37
AA59163-2IM0750-RXX-13	13	0.750	Black or Red / Type IM / Rectangular	\$ 37.16
AA59163-2IM0500-RBK-15	15	0.500	Black / Type IM / Rectangular	\$ 30.17
AA59163-2IM0500-RBK-20	20	0.500	Black / Type IM / Rectangular	\$ 31.96
AA59163-2IM0250-RXX-25	25	0.250	Black or Red / Type IM / Rectangular	\$ 29.37
AA59163-2IIM0500-TXX-25	25	0.500	Black or Red / Type IIM / Triangular	\$ 33.80
AA59163-2IM0500-RXX-25	25	0.500	Black or Red / Type IM / Rectangular	\$ 34.71
AA59163-2IIM1000-TXX-25	25	1.000	Black or Red / Type IIM / Triangular	\$ 37.91
AA59163-2IM1000-RXX-25	25	1.000	Black or Red / Type IM / Rectangular	\$ 39.64
AA59163-2IM0500-RXX-38	38	0.500	Black or Red / Type IM / Rectangular	\$ 48.77
AA59163-2IM0300-RXX-38	38	0.300	Black or Red / Type IM / Rectangular	\$ 38.47
AA59163-2IM0500-RXX-50	50	0.500	Black or Red / Type IM / Rectangular	\$ 57.13
AA59163-2IIM0500-TXX-50	50	0.500	Black or Red / Type IIM / Triangular	\$ 48.86

Guideline Color on Type IIM Triangular Tapes Only: .500mm = blue / .750mm = white / 1.000mm = green

Type IIM edge thickness is 0.215mm +/- 0.015mm

Please enquire for pricing on widths and thicknesses other than those listed above.

- Standard roll length is 36 feet / 12 Yards / 10.9 Metres; other lengths available.
- For the XX value (color code): OR = Oxide-Red, BK = Black. Other colors available.
- Certificate of Conformity: Add \$6.00 for individual roll CofC. Lot/Batch CofC \$25.00 per order line item.
- Test Report: Add \$75.00 per order line item.

Amalgamating time: Room temperature; 24 hours / at 120°C; 120 minutes / at 150°C; 35 minutes / at 200°C; 20 minutes / at 250°C; 15 minutes. Tested for short duration fluid resistance: Jet Fuel (JP5), Hydraulic Fluid (Skydrol 500B4), Mineral Oil (NATO 0142), Synthetic Oil (NATO 0156), MIL-C-87836 & Foran 141B cleaning fluids, MIL-A-8243 cooling fluid.

These tapes are guaranteed to meet specification for 1 year from date of manufacture providing tapes are stored dry at 21°C +/- 3°C or 70°F +/- 5°F. Standard tapes have an interleaved liner of polyethylene. Polyester liner available.

FlameShield™ CID AA-59163 Specification Silicone Rubber Self Fusing Electrical Insulating Tape - Technical Data

Specifications for FlameShield™ Silicone Rubber Tape (MIL-I-46852 & A-A-59163) Class 2 – Type IM and Type IIM			
Property	Standard	Nominal Test Result or Tolerance	Test Method
Thickness: 1" wide tape	0.250mm 0.500mm 0.750mm 1.000mm	+/- .002"	N/A
Width	13mm, 19mm, 25mm, 38mm, 50mm	+/- .020"	N/A
Length	10.9m	+/- 120mm	N/A
Color	Oxide-Red or Black	N/A	N/A
Guideline Color (Type II)	0.500mm Tapes: Blue 0.750mm Tapes: White 1.000mm Tapes: Green	N/A	N/A
Operating Temperature	-60°C to +260°C -76°C to +500°F	N/A	N/A
Brittle Temperature	-65°C / -85°F	N/A	N/A
Interleave Material	.002" thick Mylar	N/A	N/A
Tensile Strength	4800 kPa (minimum)	7400	ASTM D412 / D119
Dielectric Strength	0.250mm tape: 400 V/mil 0.500mm tape: 400 V/mil 0.750mm tape: 400 V/mil 1.000mm tape: 300 V/mil	575	ASTM D-149
Dielectric Constant		2.94 @ 1Khz	ASTM D150
Volume Resistivity	1.7 x 10 ¹⁴ nanoohm metre	3 x 10 ¹⁴	ASTM D149
Elongation	300% (minimum)	700	ASTM D412 / D119
Tear Strength	85 psi (minimum)	146	ASTM D624
Bond Strength (25mm Width)	0.9 kilogram-force	2.6	ASTM D2148
Adhesion	Shall not unwind more than 1.0" after 3 minutes with 600g load	0.12"	ASTM D2148
Inclined Mandrel Tack Test (inch)		0.25	ASTM D2148
Water absorption (by wt)	3% Maximum	0.9%	FED-STD-601 Method 6251
Dissipation Factor		<0.0004 @ 1 Khz	ASTM D150
Hardness, durometer Shore A	55 - 65	55	ASTM D2148 / D2240
Flame Test		Pass	FAA 60 Sec Vertical



**MIL-I-22444 Silicone Rubber Supported/Reinforced Self Fusing
 Compression & Stretch Electrical Insulation Tape**
500°F / 260°C: FlameShield™ Meets MIL-I-22444 and ASNA 5107 Specifications
Self Binding Self-Fusing Tape - High Temperature, Heat & Flame Resistant



- Self-bonds / self fuses / self amalgamating. No sticky residue or adhesive when removed. Starts fusing within minutes, fully bonded within hours. Excellent cold weather and cryogenic performance.
- Excellent for sealing ends of firesleeve: prevents sleeve from contamination and wicking liquids. Excellent for wrapping electrical & mechanical connections and splices. Makes clean and neat installations of cables, wires and hoses. Makes an instant separation bumper and provides vibration dampening. Secures insulation to hot air ducting.
- Meets Mil-i-22444 and ASNA 5107 specifications; certification available.
- Sinusoidal Fiberglass Reinforced with either 15% maximum stretch (SB15) or 25% maximum stretch (SA25) until failure of the reinforcement web.
- Used as a compression protection tape under wiring connector clamping collars.

Clear version of tape shows reinforcement layer – normally supplied in Oxide-Red or Black Color

- Equivalent to MOX SA and MOX SB series tapes SB01020, SB00520, SB01015, SB01050 & SA00520, SA01020, SA03030, SA01015; DMS-2186 Type I, EMD/EMS 2074; General Dynamics P5189 & 5-00857; General Electric A50A493-C/D & A50E112; Grumman GT353V; RMS315 Type I; Simmonds 151274 (black); IBM 6084744; RL6000SA; RL6000SB; 68N, 69N, 78N, 79N; NSN 5970-01-325-8971; NSN 5970-00-841-1172; NSN 5970-14-464-7312

FlameShield™ MIL Spec High Temperature Silicone Self Fusing Compression/Stretch Tape				
Meets MIL-I-22444 Type I				
Part Number	Tape Width Inches / mm	Thickness inches / mm	Type / Profile	Single Roll Price Per Roll
T-SR-SB15-M013-08-XX-20	1/2 / 13	0.020 / 0.5	I / Rectangular	\$ 56.33
T-SR-SA25-M013-08-XX-20	1/2 / 13	0.020 / 0.5	I / Rectangular	\$ 56.33
T-SR-SB15-68N-5970-14-464-7312-OR	3/4 / 19	0.012 / 0.3	I / Rectangular	\$ 61.37
T-SR-SB15-69N-BK	3/4 / 19	0.020 / 0.5	I / Rectangular	\$ 64.82
T-SR-SB15-78N-OR	1 / 25	0.020 / 0.5	I / Rectangular	\$ 67.29
T-SR-SB15-79N-BK	1 / 25	0.020 / 0.5	I / Rectangular	\$ 67.29
T-SR-SB15-M025-16-XX-20	1 / 25	0.020 / 0.5	I / Rectangular	\$ 67.29
T-SR-SA25-M025-16-XX-20	1 / 25	0.020 / 0.5	I / Rectangular	\$ 67.29

Please enquire for pricing on sizes other than those listed above.
This tape can be made in thicknesses from 0.010” to 0.080” and in various widths.

- Standard roll length is 36 feet / 12 Yards / 10.9 Metres.
- For the XX value (color code): OR = Oxide-Red, BK = Black. Clear & other colors available.
- Certificate of Conformity: Add \$6.00 for individual roll CofC. Lot/Batch CofC \$25.00 per order line item.
- Test Report: Add \$75.00 per order line item.

Amalgamating time: At 120°C; 120 minutes / at 150°C; 35 minutes / at 200°C; 20 minutes / at 250°C; 15 minutes

Tested for short duration fluid resistance: Jet Fuel (JP5), Hydraulic Fluid (Skydrol 500B4), Mineral Oil (NATO 0142), Synthetic Oil (NATO 0156), MIL-C-87836 & Foran 141B cleaning fluids, MIL-A-8243 cooling fluid.

These tapes are guaranteed to meet specification for 1 year from date of manufacture providing tapes are stored dry at 21°C +/- 3°C or 70°F +/- 5°F. Standard tapes have an interleaved liner of polyethylene. Polyester liner available.



Boeing DMS 2186 Silicone Rubber Self Fusing Electrical Insulating Tape
500°F / 260°C: FlameShield™ - Meets Boeing DMS 2186 Specifications – Available
as DMS 2186 Type I & Type II
Self Binding Self-Fusing Tape - High Temperature, Heat & Flame Resistant

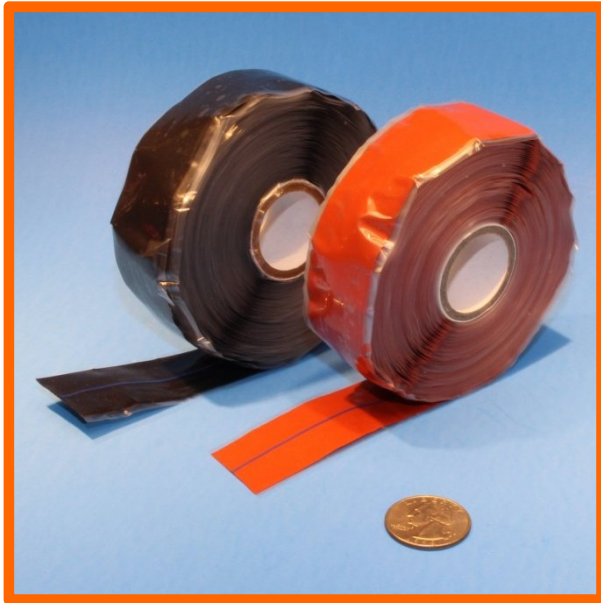

- Meets Boeing DMS2186 specifications.
- Self-bonds / self fuses / self amalgamating. No sticky residue or adhesive when removed. Starts fusing within minutes, fully bonded within hours. Excellent cold weather performance. Makes an excellent compression tape.
- Excellent for sealing ends of firesleeve: prevents sleeve from absorbing contamination and wicking liquids. Excellent for wrapping electrical & mechanical connections and splices. Makes clean and neat installations of cables, wires and hoses. Makes an instant separation bumper and provides vibration dampening.
- Type I meets MIL-I-22444 specifications. Type II meets Mil-I-46852, AA59163 and other proprietary specifications.
- Meets FAR 25.853 Appendix F, section a, 1, iv – Horizontal burn rate.
- Supplied with Certification.
- Available in Oxide-Red or Black. Oxide-Red is typically stock.

FlameShield™ Boeing DMS 2186 Type I and Type II			
High Temperature Silicone Rubber Self Fusing Compression/Stretch Tape			
Part Number	Tape Width Inches / mm	Tape Thickness inches / mm	Single Roll Price
BOEING DMS 2186 Type I (meets MIL-I-22444)			
T-SR-BOEING-DMS2186-1S-0.75-20-XX	¾ / 19	0.020 / 0.51	\$ 63.96
T-SR-BOEING-DMS2186-1S-1.00-20-XX	1 / 25	0.020 / 0.51	\$ 88.96
BOEING DMS 2186 Type II (meets MIL-I-46852 / AA-59163)			
T-SR-BOEING-DMS2186-2-1.00-20-XX	1 / 25	0.020 / 0.51	\$ 45.46
T-SR-BOEING-DMS2186-2-1.00-30-XX	1 / 25	0.030 / 0.76	\$ 59.10
T-SR-BOEING-DMS2186-2-1.00-40-XX	1 / 25	0.040 / 1.01	\$ 72.97
T-SR-BOEING-DMS2186-2-1.25-50-XX	1 1/4 / 32	0.050 / 1.27	\$ 83.91
T-SR-BOEING-DMS2186-2-1.25-60-XX	1 1/2 / 38	0.060 / 1.52	\$ 96.74
T-SR-BOEING-DMS2186-2-1.25-80-XX	1 1/2 / 38	0.080 / 2.03	\$ 112.12

- Standard roll length is 36 feet / 12 Yards / 10.9 Metres; other lengths available.
- For the XX value (color code): OR = Oxide-Red, BK = Black
- DMS2186 specification does not allow tapes to be thinner than .020"

These tapes are guaranteed to meet specification for 1 year from date of manufacture providing tapes are stored dry at 21°C +/- 3°C or 70°F +/- 5°F. Recertification is available.



Lockheed Martin Astronautics MMS J517 Type I & Type II Silicone Rubber Tape

500°F / 260°C: FlameShield™ Self Fusing Electrical Insulating Tape
Self Binding Self-Fusing Tape - High Temperature, Heat & Flame Resistant

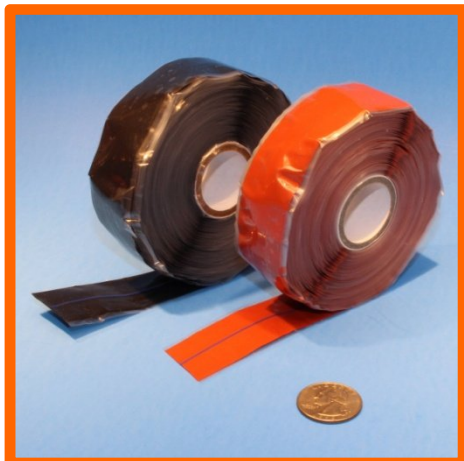

- Self-bonds / self fuses / self amalgamating. No sticky residue or adhesive when removed. Starts fusing within minutes, fully bonded within hours. Excellent cold weather performance. Makes an excellent compression tape.
- Excellent for sealing ends of firesleeve: prevents sleeve from absorbing contamination and wicking liquids. Excellent for wrapping electrical & mechanical connections and splices. Makes clean and neat installations of cables, wires and hoses. Makes an instant separation bumper and provides vibration dampening.
- Meets Mil-I-46852 and AA59163 and other specifications.
- Supplied with Certification.

FlameShield™ High Temperature Silicone Rubber Self Fusing Compression/Stretch Electrical Insulating Tape – Meets MMS J517 Type I and Type II Specifications			
Part Number	Tape Width Inches / mm	Tape Thickness inches / mm	Price Per Roll
MMS J517 Type I			
T-SR-MMSJ517-1-08-10	1/2 / 13	0.010 / 0.25	\$ 27.12
T-SR- MMSJ517-1-08-20	1/2 / 13	0.020 / 0.51	\$ 28.66
T-SR-MMSJ517-1-08-30	1/2 / 13	0.030 / 0.76	\$ 30.46
T-SR-MMSJ517-1-12-10	3/4 / 19	0.010 / 0.25	\$ 29.55
T-SR-MMSJ517-1-12-20	3/4 / 19	0.020 / 0.51	\$ 31.28
T-SR-MMSJ517-1-12-30	3/4 / 19	0.030 / 0.76	\$ 34.81
T-SR-MMSJ517-1-16-10	1 / 25	0.010 / 0.25	\$ 30.93
T-SR-MMSJ517-1-16-20	1 / 25	0.020 / 0.51	\$ 33.80
T-SR-MMSJ517-1-16-30	1 / 25	0.030 / 0.76	\$ 36.91
T-SR-MMSJ517-1-20-10	1.25 / 32	0.010 / 0.25	\$ 38.77
T-SR-MMSJ517-1-20-20	1.25 / 32	0.020 / 0.51	\$ 40.21
T-SR-MMSJ517-1-20-30	1.25 / 32	0.030 / 0.76	\$ 42.37
T-SR-MMSJ517-1-24-10	1.50 / 38	0.010 / 0.25	\$ 43.66
T-SR-MMSJ517-1-24-20	1.50 / 38	0.020 / 0.51	\$ 47.82
T-SR-MMSJ517-1-24-30	1.50 / 38	0.030 / 0.76	\$ 55.37
MMS J517 Type II			
T-SR-MMSJ517-2-16-20-XX	1 / 25	0.020 / 0.51	\$ 33.80
T-SR-MMSJ517-2-16-30-XX	1 / 25	0.030 / 0.76	\$ 42.88
T-SR-MMSJ517-2-16-40-XX	1 / 25	0.040 / 1.01	\$ 47.37
T-SR-MMSJ517-2-20-50-XX	1 1/4 / 32	0.050 / 1.27	\$ 53.91
T-SR-MMSJ517-2-24-60-XX	1 1/2 / 38	0.060 / 1.52	\$ 56.74
T-SR-MMSJ517-2-24-80-XX	1 1/2 / 38	0.080 / 2.03	\$ 63.12

- Standard roll length is 36 feet / 12 Yards / 10.9 Metres; other lengths available.
- For the XX value (color code): OR = Oxide-Red, BK = Black

These tapes are guaranteed to meet specification for 1 year from date of manufacture providing tapes are stored dry at 21°C +/- 3°C or 70°F +/- 5°F. Standard tapes have an interleaved liner of polyethylene. Polyester liner available.



Lockheed Martin Space Systems 5-00857 & 5-00615 Silicone Tape
500°F / 260°C: FlameShield™ Silicone Rubber Self Fusing Compression & Stretch
Electrical Insulating Tape
Self Binding Self-Fusing Tape - High Temperature, Heat & Flame Resistant

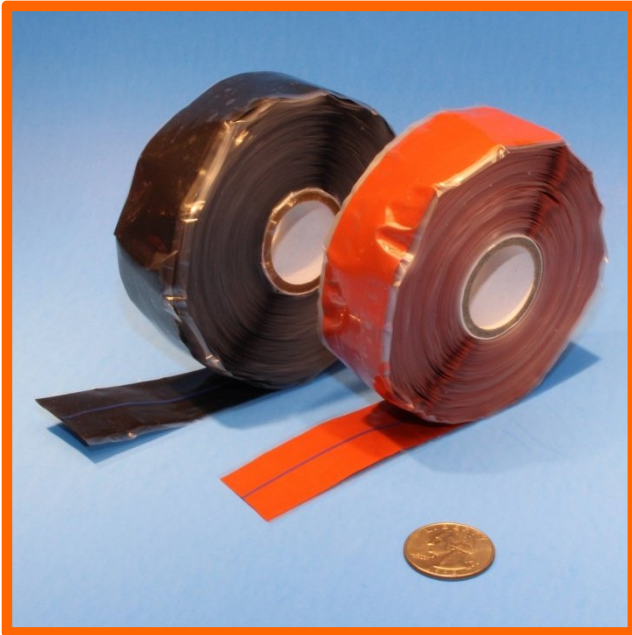

- Meets Lockheed-Martin 5-00857 & 5-00615 specifications.
- Self-bonds / self fuses / self amalgamating. No sticky residue or adhesive when removed. Starts fusing upon contact, fully bonded within hours. Excellent cold weather performance. Makes an excellent compression tape.
- Excellent for sealing ends of firesleeve; prevents sleeve from absorbing contamination and wicking liquids. Excellent for wrapping electrical & mechanical connections and splices. Makes clean and neat installations of cables, wires and hoses. Makes an instant separation bumper and provides vibration dampening.
- Meets Mil-I-46852 and AA59163 and other proprietary specifications.
- Supplied with Certification.

FlameShield™ High Temperature Silicone Rubber Self Fusing Compression/Stretch Tape			
Meets Lockheed Martin Space Systems 5-00857 & 5-00615 Specifications			
Part Number	Tape Width Inches / mm	Tape Thickness inches / mm	Price Per Roll
Specification 5-00857			
T-SR-5-00857-S-X-Y-ZZ	As per specification	As per specification	\$ by quote
Specification 5-00615			
T-SR-5-00615	As per specification	As per specification	\$ 34.71

- For the X value, specify width
- For the Y value, specify thickness
- Standard roll length is 36 feet / 12 Yards / 10.9 Metres; other lengths available.
- For the ZZ value (color code): OR = Oxide-Red, BK = Black

These tapes are guaranteed to meet specification for 1 year from date of manufacture providing tapes are stored dry at 21°C +/- 3°C or 70°F +/- 5°F. Standard tapes have an interleaved liner of polyethylene. Polyester liner available.



Lockheed Martin Tactical Systems P5189 Silicone Tape
500°F / 260°C: FlameShield™ Silicone Rubber Self Fusing Compression & Stretch
Electrical Insulating Tape
Self Binding Self-Fusing Tape - High Temperature, Heat & Flame Resistant

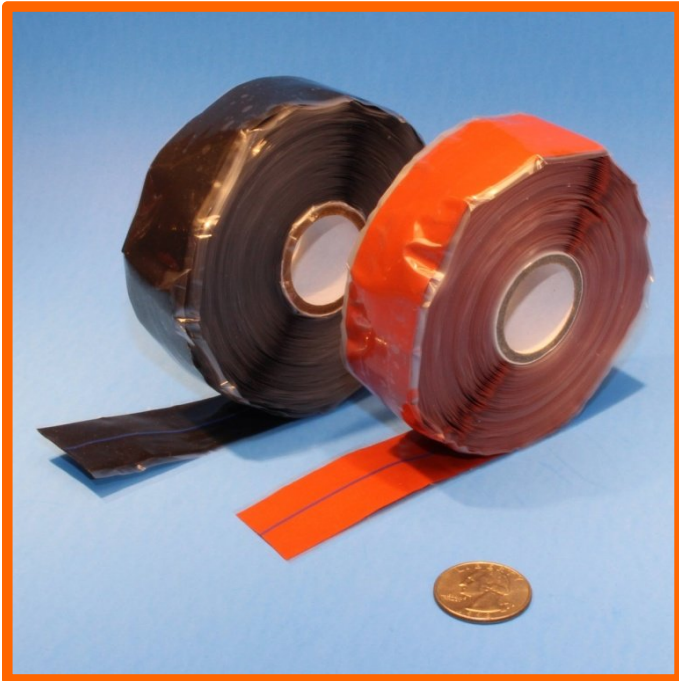

- Meets Lockheed-Martin Tactical Systems P5189 specifications.
- Self-bonds / self fuses / self amalgamating. No sticky residue or adhesive when removed. Starts fusing upon contact, fully bonded within hours. Excellent cold weather performance. Makes an excellent compression tape.
- Excellent for sealing ends of firesleeve: prevents sleeve from absorbing contamination and wicking liquids. Excellent for wrapping electrical & mechanical connections and splices. Makes clean and neat installations of cables, wires and hoses. Makes an instant separation bumper and provides vibration dampening.
- Meets Mil-I-46852 and AA59163 and other proprietary specifications.
- Supplied with Certification.

FlameShield™ High Temperature Silicone Rubber Self Fusing Compression/Stretch Electrical Insulating Tape Meets Lockheed Martin Tactical Systems P5189 Specifications			
Part Number	Tape Width Inches / mm	Tape Thickness inches / mm	Price Per Roll
Specification P5189			
T-SR-P5189-S-08	1/2 / 13	As per specification	\$ 35.81
T-SR-P5189-S-16	1 / 25	As per specification	\$ 46.43

- Standard roll length is 36 feet / 12 Yards / 10.9 Metres; other lengths available.

These tapes are guaranteed to meet specification for 1 year from date of manufacture providing tapes are stored dry at 21°C +/- 3°C or 70°F +/- 5°F. Standard tapes have an interleaved liner of polyethylene. Polyester liner available.



Lockheed Martin Systems Integration 6084744 Silicone Rubber Tape
500°F / 260°C: FlameShield™ Silicone Rubber Self Fusing Compression & Stretch
Electrical Insulating Tape
Self Binding Self-Fusing Tape - High Temperature, Heat & Flame Resistant

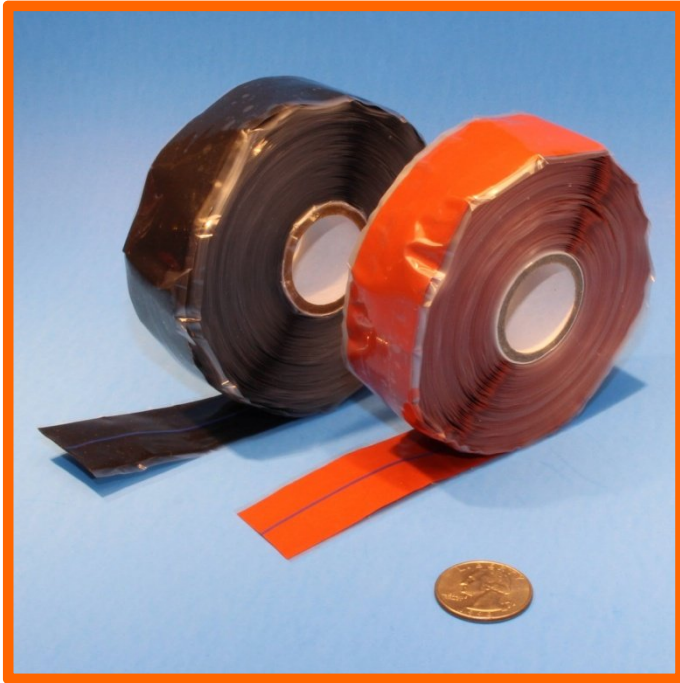

- Self-bonds / self fuses / self amalgamating. No sticky residue or adhesive when removed. Starts fusing upon contact, fully bonded within hours. Excellent cold weather performance. Makes an excellent compression tape.
- Excellent for sealing ends of firesleeve: prevents sleeve from absorbing contamination and wicking liquids. Excellent for wrapping electrical & mechanical connections and splices. Makes clean and neat installations of cables, wires and hoses. Makes an instant separation bumper and provides vibration dampening.
- Meets Mil-I-46852 and AA59163 and other proprietary specifications.
- Supplied with Certification.

FlameShield™ High Temperature Silicone Rubber Self Fusing Compression/Stretch Electrical Insulating Tape Meets Lockheed Martin Systems Integration 6084744 Specifications			
Part Number	Tape Width Inches / mm	Tape Thickness inches / mm	Price Per Roll
Specification 6084744			
T-SR-6084744-08-S15-XX	1/2 / 13	As per specification	\$ 35.81
T-SR-6084744-16-S15-XX	1 / 25	As per specification	\$ 46.43
T-SR-6084744-08-S25-XX	1/2 / 13	As per specification	\$ 35.81
T-SR-6084744-16-S25-XX	1 / 25	As per specification	\$ 46.43

- Standard roll length is 36 feet / 12 Yards / 10.9 Metres; other lengths available.
- For the XX value (color code): OR = Oxide-Red, BK = Black

These tapes are guaranteed to meet specification for 1 year from date of manufacture providing tapes are stored dry at 21°C +/- 3°C or 70°F +/- 5°F. Standard tapes have an interleaved liner of polyethylene. Polyester liner available.



General Dynamics P5384 Silicone Rubber Tape
500°F / 260°C: FlameShield™ Silicone Rubber Self Fusing Compression & Stretch
Electrical Insulating Tape
Self Binding Self-Fusing Tape - High Temperature, Heat & Flame Resistant

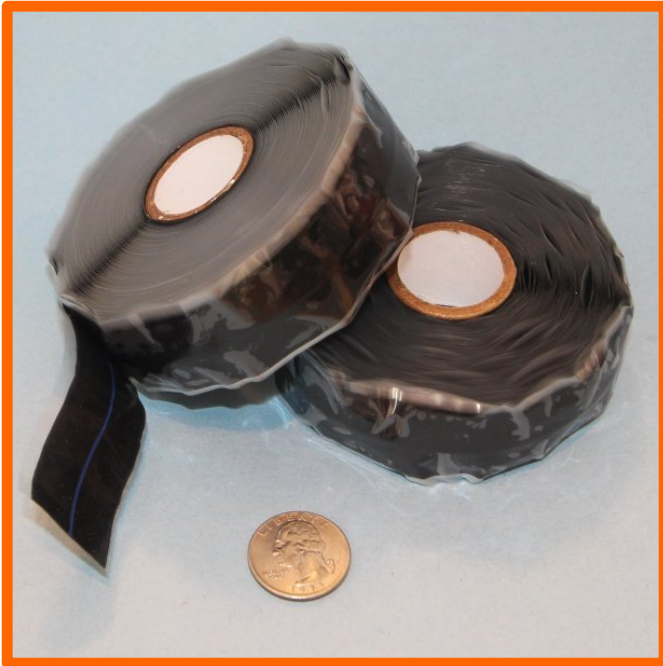

- Meets General Dynamics P5384 specifications.
- Self-bonds / self fuses / self amalgamating. No sticky residue or adhesive when removed. Starts fusing upon contact, fully bonded within hours. Excellent cold weather performance. Makes an excellent compression tape.
- Excellent for sealing ends of firesleeve: prevents sleeve from absorbing contamination and wicking liquids. Excellent for wrapping electrical & mechanical connections and splices. Makes clean and neat installations of cables, wires and hoses. Makes an instant separation bumper and provides vibration dampening.
- Meets Mil-I-46852 and AA59163 and other proprietary specifications.
- Supplied with Certification.

FlameShield™ High Temperature Silicone Rubber Self Fusing Compression/Stretch Electrical Insulating Tape Meets General Dynamics P5384 Specifications			
Part Number	Tape Width Inches / mm	Tape Thickness	Price Per Roll
T-SR-P5384	As per specification	As per specification	\$ 37.91

- Standard roll length is 36 feet / 12 Yards / 10.9 Metres; other lengths available.
- This tape is Black per the specification.

These tapes are guaranteed to meet specification for 1 year from date of manufacture providing tapes are stored dry at 21°C +/- 3°C or 70°F +/- 5°F. Standard tapes have an interleaved liner of polyethylene. Polyester liner available.



UL 94V0 and/or UL 94HB Flamability Standards Silicone Tape
500°F / 260°C: FlameShield™ Silicone Rubber Self Fusing Compression & Stretch
Electrical Insulating Tape – Flame Retardant
Self Binding Self-Fusing Tape - High Temperature, Heat & Flame Resistant

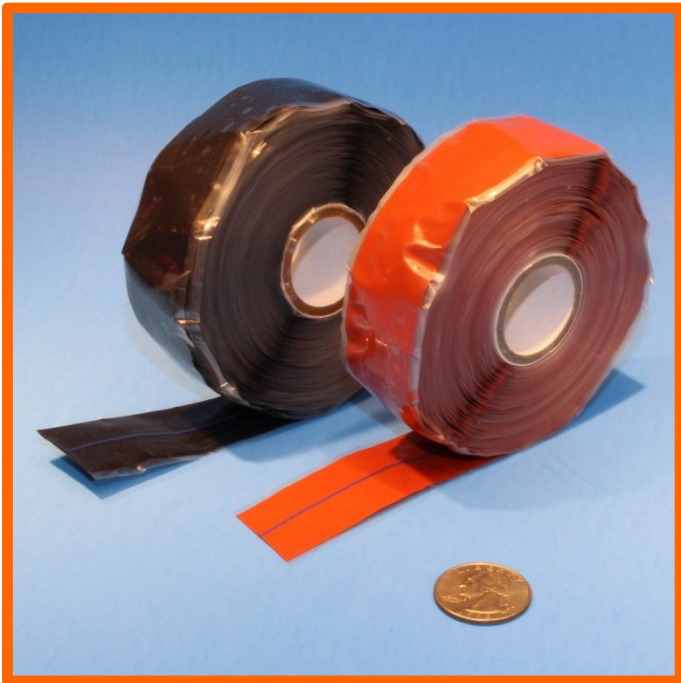

- Self-bonds / self fuses / self amalgamating. No sticky residue or adhesive when removed. Starts fusing upon contact, fully bonded within hours. Excellent cold weather performance. Makes an excellent compression tape.
- Excellent for sealing ends of firesleeve: prevents sleeve from absorbing contamination and wicking liquids. Excellent for wrapping electrical & mechanical connections and splices. Makes clean and neat installations of cables, wires and hoses. Makes an instant separation bumper and provides vibration dampening.
- Meets Mil-I-46852 and AA59163 and other proprietary specifications.
- Supplied with Certification.

**FlameShield™ MIL Spec High Temperature Silicone Self Fusing
 Compression/Stretch Electrical Insulating Tape – Flame Retardant**
**Meets UL 94V0 and/or UL 94HB Flame Test Standards and
 MIL-I-46852 and A-A-59163 Specifications**

Part Number	Tape Width Inches / mm	Thickness inches / mm	Type / Profile	Single Roll Price Per Roll
T-SR-UL-08-RBK-20	1/2 / 13	0.020 / 0.5	I / Rectangular	\$ 34.37
T-SR-UL-08-RXX-30	1/2 / 13	0.030 / 0.76	I / Rectangular	\$ 42.16
T-SR-UL-12-RBK-20	3/4 / 19	0.020 / 0.5	I / Rectangular	\$ 36.96
T-SR-UL-16-TXX-20	1 / 25	0.020 / 0.5	II / Triangular	\$ 38.80
T-SR-UL-16-RXX-20	1 / 25	0.020 / 0.5	I / Rectangular	\$ 39.71
T-SR-UL-16-TXX-40	1 / 25	0.040 / 1.0	II / Triangular	\$ 42.91
T-SR-UL-24-TXX-60	1 ½ / 38	0.060 / 1.5	II / Triangular	\$ 52.82
T-SR-UL-24-ROR-20	1 ½ / 38	0.020 / 0.5	I / Rectangular	\$ 53.77
T-SR-UL-32-TXX-30	2 / 51	0.030 / 0.76	II / Triangular	\$ 54.26
T-SR-UL-32-RXX-30	2 / 51	0.030 / 0.76	I / Rectangular	\$ 58.73

- Standard roll length is 36 feet / 12 Yards / 10.9 Metres
- Other widths, thicknesses and lengths available.
- For the XX value (color code): OR = Oxide-Red, BK = Black



Rockwell International ST0130RB0078 Silicone Rubber Tape
500°F / 260°C: FlameShield™ Silicone Rubber Self Fusing Compression & Stretch
Electrical Insulating Tape
Self Binding Self-Fusing Tape - High Temperature, Heat & Flame Resistant

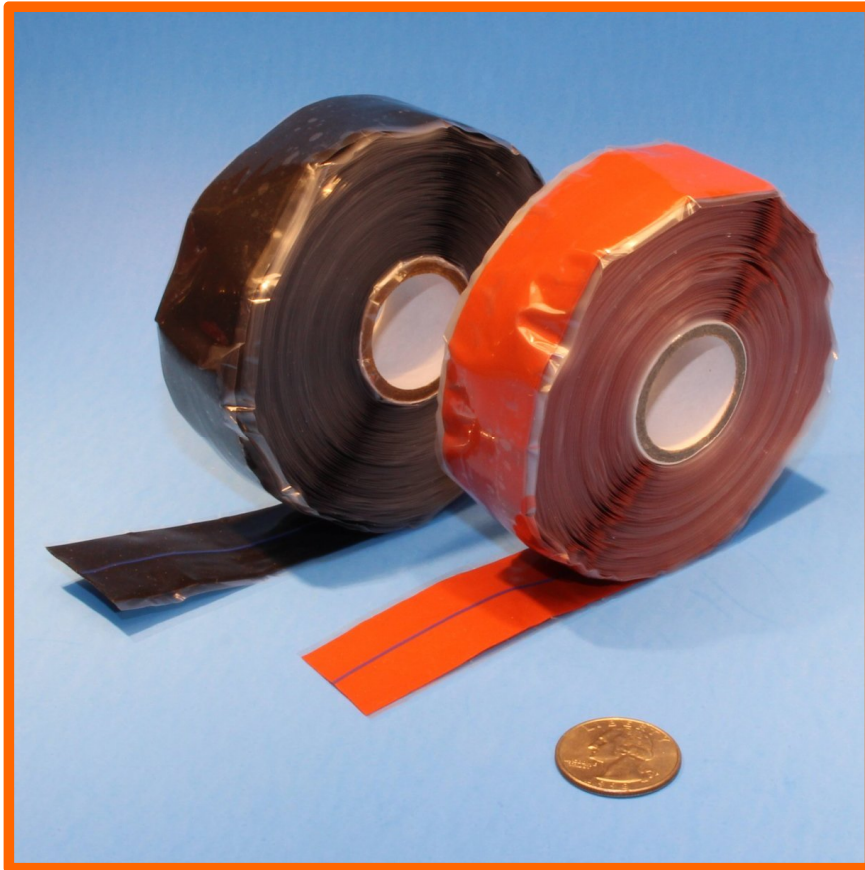

- Self-bonds / self fuses / self amalgamating. No sticky residue or adhesive when removed. Starts fusing within minutes, fully bonded within hours. Excellent cold weather performance. Makes an excellent compression tape.
- Excellent for sealing ends of firesleeve: prevents sleeve from absorbing contamination and wicking liquids. Excellent for wrapping electrical & mechanical connections and splices. Makes clean and neat installations of cables, wires and hoses. Makes an instant separation bumper and provides vibration dampening.
- Meets Mil-I-46852 and AA59163 and other proprietary specifications.
- Supplied with Certification.

FlameShield™ Rockwell International ST0130RB0078 High Temperature Silicone Rubber Self Fusing Compression/Stretch Tape			
Part Number	Tape Width Inches / mm	Tape Thickness Inches / mm	Price Per Roll
ST0130RB0078 Type I Tape			
T-SR-ST0130RB0078-1T	As per specification	As per specification	\$ 33.80
ST0130RB0078 Type II Tape			
T-SR-ST0130RB0078-2R-12	As per specification	0.012 / 0.30	\$ 30.47
T-SR-ST0130RB0078-2R-15	As per specification	0.015 / 0.38	\$ 32.88
T-SR-ST0130RB0078-2R-20	As per specification	0.020 / 0.51	\$ 34.71

- Standard roll length is 36 feet / 12 Yards / 10.9 Metres; other lengths available.
- All versions of ST0130RB0078 are Oxide-Red

These tapes are guaranteed to meet specification for 1 year from date of manufacture providing tapes are stored dry at 21°C +/- 3°C or 70°F +/- 5°F. Standard tapes have an interleaved liner of polyethylene. Polyester liner available.



General Electric Power Generation A50A493 & 3003M70P Silicone Rubber Tape

500°F / 260°C: FlameShield™ Silicone Rubber Self Fusing Compression & Stretch Electrical Insulating Tape

Self Binding Self-Fusing Tape - High Temperature, Heat & Flame Resistant

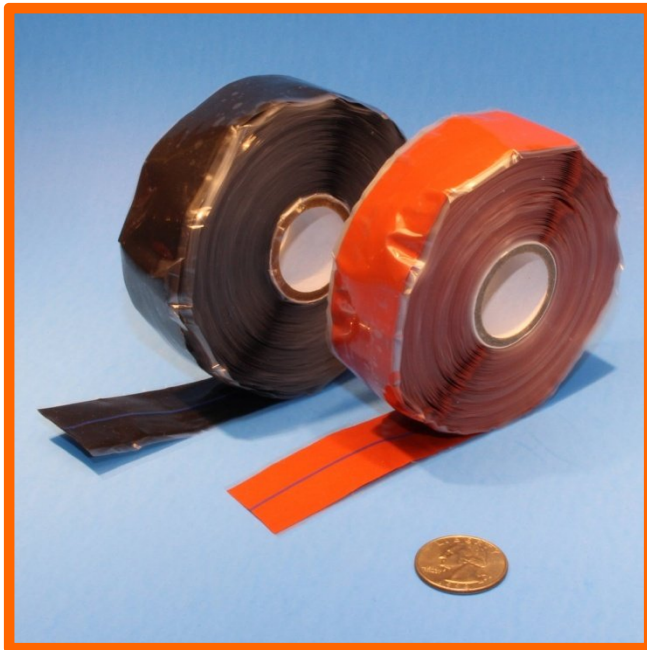

- Self-bonds / self fuses / self amalgamating. No sticky residue or adhesive when removed. Starts fusing within minutes, fully bonded within hours. Excellent cold weather performance. Makes an excellent compression tape.
- Excellent for sealing ends of firesleeve: prevents sleeve from absorbing contamination and wicking liquids. Excellent for wrapping electrical & mechanical connections and splices. Makes clean and neat installations of cables, wires and hoses. Makes an instant separation bumper and provides vibration dampening.
- Meets Mil-I-46852 and AA59163 and other proprietary specifications.
- Supplied with Certification.

FlameShield™ General Electric Power Generation Standard A50A493 & 3003M70 High Temperature Silicone Rubber Self Fusing Compression/Stretch Tape			
Part Number	Tape Width Inches / mm	Tape Thickness Inches / mm	Price Per Roll
A50A493A Tape:			
T-SR-GEPG-93A-T-16-20	1 / 25	0.020 / 0.51	\$ 33.80
A50A493B Tape:			
T-SR-GEPG-93B-T-16-40	1 / 25	0.040 / 1.02	\$ 37.91
A50A493C Tape:			
T-SR-GEPG-93C-R-16-20	1 / 25	0.020 / 0.51	\$ 46.43
A50A493D Tape:			
T-SR-GEPG-93D-R-48-30	3 / 76	0.030 / 0.76	\$ 104.87
3003M70P01 Tape:			
T-SR-GEPG-P01-T-16-20	1 / 25	0.020 / 0.51	\$ 33.80
3003M70P02 Tape:			
T-SR-GEPG-P02-R-12-20	3/4 / 19	0.020 / 0.51	\$ 31.96
3003M70P03 Tape:			
T-SR-GEPG-P03-R-08-20	1/2 / 13	0.020 / 0.51	\$ 29.37
3003M70P04 Tape:			
T-SR-GEPG-P04-R-24-60	3 / 76	0.060 / 1.52	\$ 48.77

- Standard roll length is 36 feet / 12 Yards / 10.9 Metres; other lengths available.
- All versions of A50A493 are Oxide-Red



General Electric Transportation Systems A50E112 & EMS2074 Silicone Rubber Tape
500°F / 260°C: FlameShield™ Silicone Rubber Self Fusing Compression & Stretch Electrical Insulating Tape
Self Binding Self-Fusing Tape - High Temperature, Heat & Flame Resistant

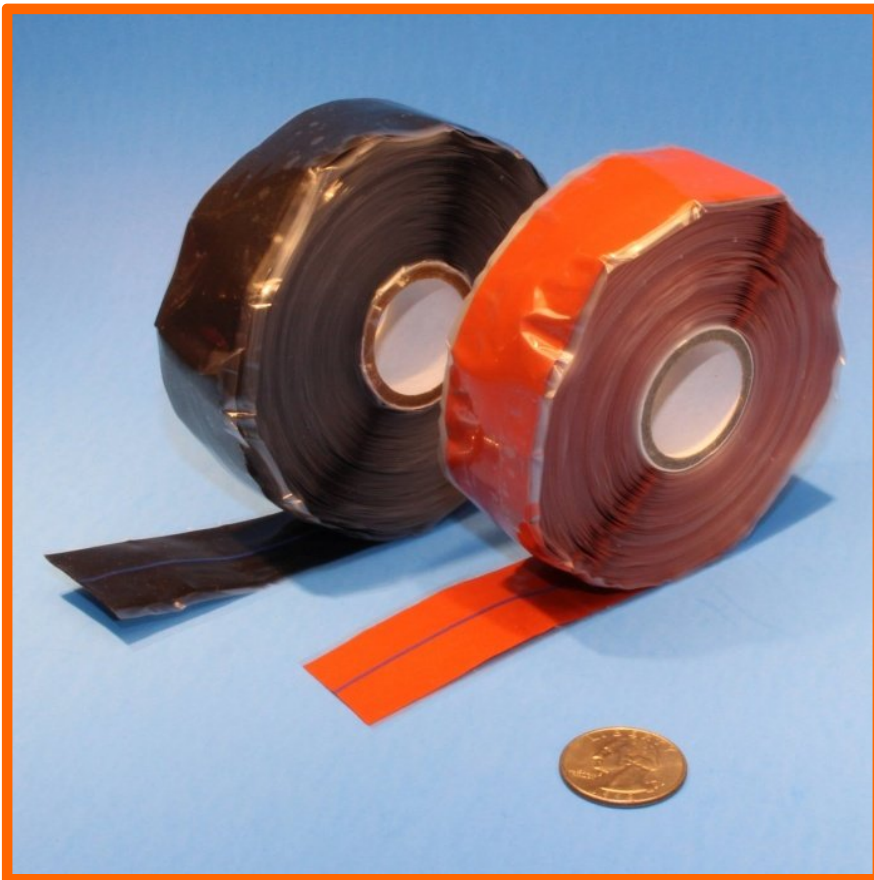

- Self-bonds / self fuses / self amalgamating. No sticky residue or adhesive when removed. Starts fusing within minutes, fully bonded within hours. Excellent cold weather performance. Makes an excellent compression tape.
- Excellent for sealing ends of firesleeve: prevents sleeve from absorbing contamination and wicking liquids. Excellent for wrapping electrical & mechanical connections and splices. Makes clean and neat installations of cables, wires and hoses. Makes an instant separation bumper and provides vibration dampening.
- Meets Mil-I-46852 and AA59163 and other proprietary specifications.
- Supplied with Certification.

FlameShield™ General Electric Transportation Systems Standard A50E112 & EMS2074 – Junction Insulation Tape High Temperature Silicone Rubber Self Fusing Compression/Stretch Tape			
Part Number	Tape Width Inches / mm	Tape Thickness Inches / mm	Price Per Roll
A50E112 Tape & 8355873 Tape			
T-SR-GETS-R-S-16-20	1 / 25	0.020 / 0.51	\$ 33.80
A50E112 Tape & 8355873 Tape High Strength Version			
T-SR-GETS-R-16-30HS	1 / 25	0.030 / 1.02	\$ 44.91

- Standard roll length is 36 feet / 12 Yards / 10.9 Metres; other lengths available.
- Tapes are Oxide-Red
- Standard version is 1362 psi / High Strength version is 1500 psi

These tapes are guaranteed to meet specification for 1 year from date of manufacture providing tapes are stored dry at 21°C +/- 3°C or 70°F +/- 5°F. Standard tapes have an interleaved liner of polyethylene. Polyester liner available.



Rohr RMS315 Silicone Rubber Tape
500°F / 260°C: FlameShield™ Silicone Rubber Self Fusing Compression & Stretch
Electrical Insulating Tape
Self Binding Self-Fusing Tape - High Temperature, Heat & Flame Resistant

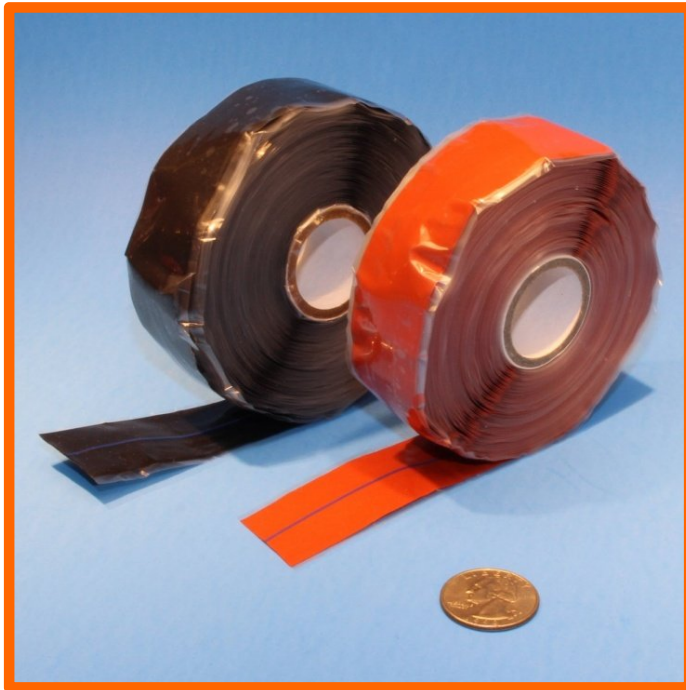

- Self-bonds / self fuses / self amalgamating. No sticky residue or adhesive when removed. Starts fusing within minutes, fully bonded within hours. Excellent cold weather performance. Makes an excellent compression tape.
- Excellent for sealing ends of firesleeve: prevents sleeve from absorbing contamination and wicking liquids. Excellent for wrapping electrical & mechanical connections and splices. Makes clean and neat installations of cables, wires and hoses. Makes an instant separation bumper and provides vibration dampening.
- Meets Mil-I-46852 and AA59163 and other proprietary specifications.
- Meets FAR 25.853 Appendix F, section a, 1, iv – Horizontal burn rate.
- Supplied with Certification.

FlameShield™ Rohr RMS315 Tape			
High Temperature Silicone Rubber Self Fusing Compression/Stretch Tape			
Part Number	Tape Width Inches / mm	Tape Thickness Inches / mm	Price Per Roll
Rohr RMS315 Type I Tape			
T-SR-RMS315-S-08-20-XX	1/2 / 13	As per specification	\$ 47.76
T-SR-RMS315-S-16-12-XX	1 / 25	As per specification	\$ 64.29
T-SR-RMS315-S-16-20-XX	1.25 / 32	As per specification	\$ 67.96
Rohr RMS315 Type II Tape			
T-SR-RMS315-2T-20-XX	As per specification	0.020 / 0.51	\$ 33.80
T-SR-RMS315-2T-30-XX	As per specification	0.030 / 0.76	\$ 35.71
T-SR-RMS315-2T-A-40-XX	As per specification	0.040 / 1.01	\$ 37.33
T-SR-RMS315-2T-B-40-XX	As per specification	0.040 / 1.01	\$ 42.87
T-SR-RMS315-2T-A-50-XX	As per specification	0.050 / 1.01	\$ 44.63
T-SR-RMS315-2T-B-50-XX	As per specification	0.050 / 1.01	\$ 47.37
T-SR-RMS315-2T-60-XX	As per specification	0.060 / 1.01	\$ 49.88
T-SR-RMS315-2T-70-XX	As per specification	0.070 / 1.01	\$ 52.67
Rohr RMS315 Type III Tape			
T-SR-RMS315-3R	As per specification	As per specification	\$ 35.62

- Standard roll length is 36 feet / 12 Yards / 10.9 Metres; other lengths available.
- For the XX value (color code): OR = Oxide-Red, BK = Black



Garmin 249-00114-00 Silicone Rubber Tape
500°F / 260°C: FlameShield™ Silicone Rubber Self Fusing Compression & Stretch
Electrical Insulating Tape
High Temperature, Heat & Flame Resistant

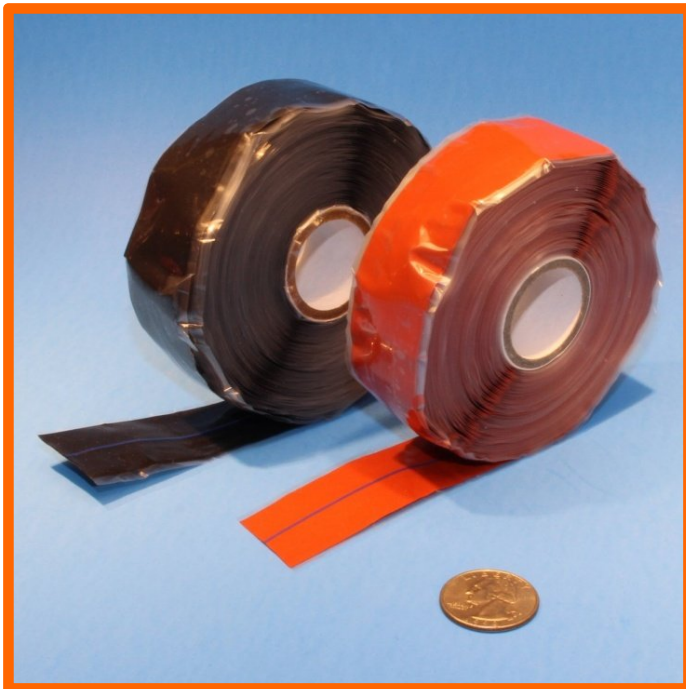

- Garmin 249-00114-00 tape.
- Self-bonds / self fuses / self amalgamating. No sticky residue or adhesive when removed. Starts fusing upon contact, fully bonded within hours. Excellent cold weather performance. Makes an excellent compression tape.
- Used to protect wiring at the backshell clamp from clamping damage. Also provides equalization of strain relief.
- Used to build up the diameter of the wire bundle so that the cable clamp on the backshell will hold the wires in situations where too few wires would have resulted in the clamp not contacting the wires, resulting in strain on the connector's internal pins.
- Meets Mil-I-46852 / AA59163 and other proprietary specifications.
- Supplied with Certification.

FlameShield™ High Temperature Silicone Rubber Self Fusing Compression/Stretch Tape Garmin 249-00114-00			
Part Number	Tape Width Inches / mm	Tape Thickness inches / mm	Price Per Roll
T-SR-Garmin-249-00114	As per specification	As per specification	\$ 33.64

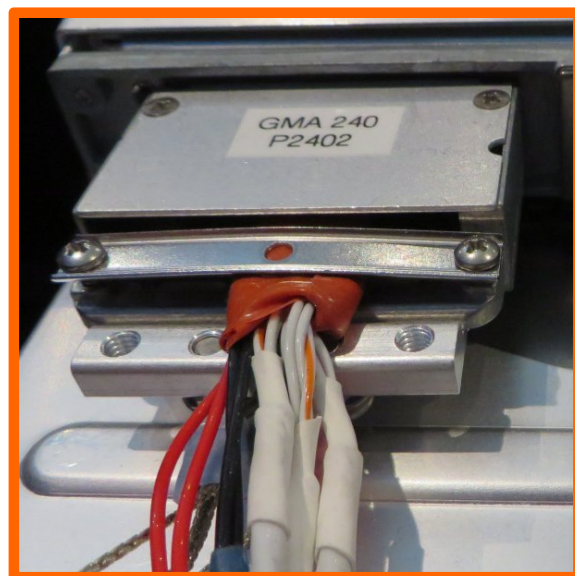
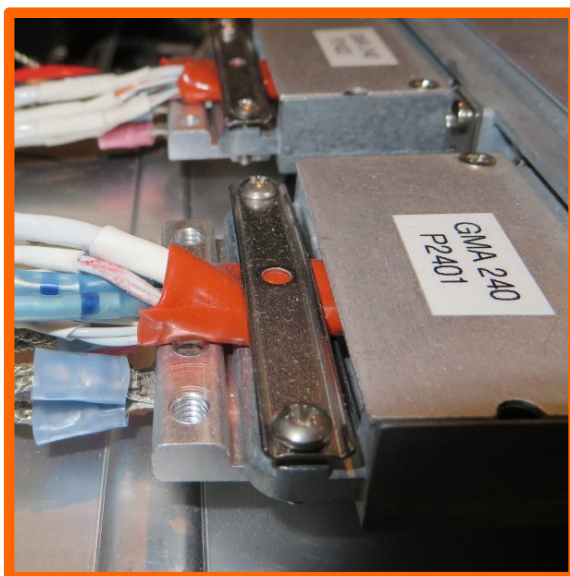

Amphenol Connector Backshell Strain Relief Isolation Tape/Bushing
500°F / 260°C: FlameShield™ Silicone Rubber Isolation Tape
High Temperature, Heat & Flame Resistant

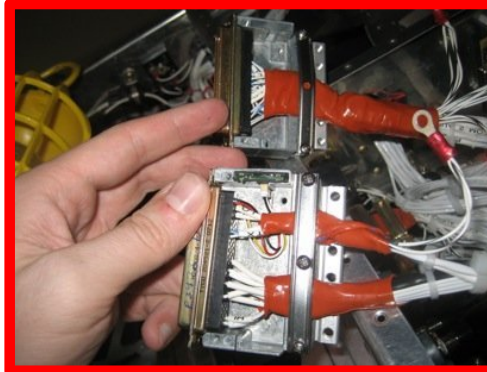
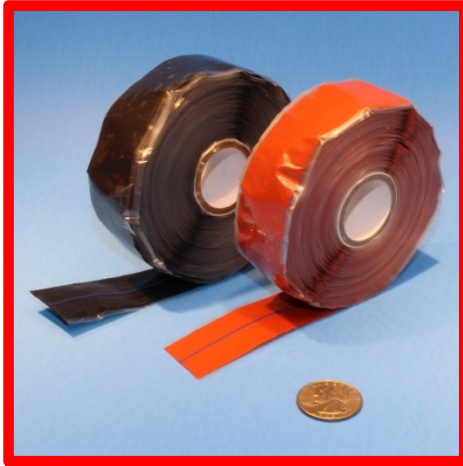

- Suitable for all Amphenol round and flat backshell strain relief clamps.
- Equivalent to Garmin 249-00114-00 tape for aviation use.
- Self-bonds / self fuses / self amalgamating. No sticky residue or adhesive when removed. Starts fusing upon contact, fully bonded within hours. Excellent cold weather performance. Makes an excellent compression tape. Used to protect wiring at the backshell clamp from clamping damage. Also provides equalization of strain relief.
- Used to build up the diameter of the wire bundle so that the cable clamp on the backshell will hold the wires in situations where too few wires would have resulted in the clamp not contacting the wires, resulting in strain on the connector's internal pins.
- Meets all Mil-I-46852 / AA59163 and other proprietary electrical and mechanical specifications. Available as Class 1 Type I and Type II or Class 2 tape Type I and Type II. (Class 1 is inch-pound specification, Class 2 is millimetre-kg specification)
- Available in Oxide-Red, Black. A supported re-enforced version is available. Tape thickness includes .020", .030" and .040". Widths include 0.5", 0.75", 1.00", 1.50", 2.00". Available in Rectangular (Type I) and Triangular (Type II) profiles. Certification available.

Amphenol Connector Backshell Strain Relief Isolation Tape				
Meets MIL-I-46852 / A-A-59163 / ABS 5334 Specifications - Type I and Type II				
Part Number	Tape Width Inches / mm	Thickness inches / mm	Color / Type / Profile	Single Roll Price Per Roll
T-SR-AMPHENOL-08-RB-20	1/2 / 12.7	0.020 / 0.508	Black / I / Rectangular	\$ 29.37
T-SR-AMPHENOL-08-RX-30	1/2 / 12.7	0.030 / 0.760	Black or Red / I / Rectangular	\$ 37.16
T-SR-AMPHENOL-10-RB-20	5/8 / 15.7	0.020 / 0.508	Black / I / Rectangular	\$ 30.17
T-SR-AMPHENOL-12-RB-20	3/4 / 19	0.020 / 0.508	Black / I / Rectangular	\$ 31.96
T-SR-AMPHENOL-16-TX-20	1 / 25.4	0.020 / 0.508	Black or Red / II / Triangular	\$ 33.80
T-SR-AMPHENOL-16-RX-20	1 / 25.4	0.020 / 0.508	Black or Red / I / Rectangular	\$ 34.71
T-SR-AMPHENOL-16-TX-40	1 / 25.4	0.040 / 1.000	Black or Red / II / Triangular	\$ 37.91
T-SR-AMPHENOL-16-RX-40	1 / 25.4	0.040 / 1.000	Black or Red / I / Rectangular	\$ 39.64
T-SR-AMPHENOL-24-RX-20	1 1/2 / 38.1	0.020 / 0.508	Black or Red / I / Rectangular	\$ 48.77
T-SR-AMPHENOL-24-RX-12	1 1/2 / 38.1	0.012 / 0.304	Black or Red / I / Rectangular	\$ 38.47
Guideline Color on Triangular Tapes Only: .020" = blue / .030" = white / .040" = green				

- Standard roll length is 36 feet / 12 Yards / 10.9 Metres; other lengths available.
- For the X value (color code): O = Oxide-Red, B = Black



FAR 25.853 - Appendix F Horizontal and Vertical Burn Rate Limits

Silicone Rubber Tape

500°F / 260°C: FlameShield™ Silicone Rubber Self Fusing Compression & Stretch Electrical Insulating Tape

Self Binding Self-Fusing Tape - High Temperature, Heat & Flame Resistant

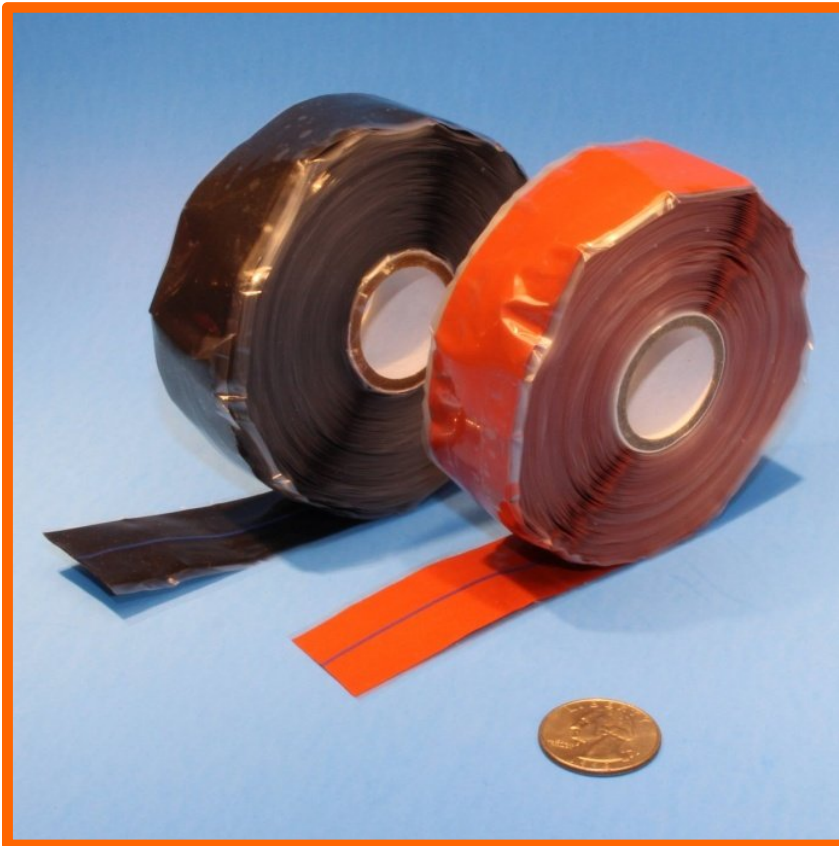

- Self-bonds / self fuses / self amalgamating. No sticky residue or adhesive when removed. Starts fusing within minutes, fully bonded within hours. Excellent cold weather performance. Makes an excellent compression tape.
- Excellent for sealing ends of firesleeve: prevents sleeve from absorbing contamination and wicking liquids. Excellent for wrapping electrical & mechanical connections and splices. Makes clean and neat installations of cables, wires and hoses. Makes an instant separation bumper and provides vibration dampening.
- Meets Mil-I-46852 and AA59163 and other proprietary specifications.
- Meets FAR 25.853 Appendix F, section a, 1, iv – Horizontal burn rate.
- Meets FAR 25.853 Appendix F, section a, 1, ii – Vertical burn rate
- Supplied with Certification.

FlameShield™ FAR 25.853 Tape High Temperature Silicone Rubber Self Fusing Compression/Stretch Tape			
Part Number	Tape Width Inches / mm	Tape Thickness Inches / mm	Price Per Roll
FAR 25.853 Type I Tape (Other Widths / Thickness / Lengths Available)			
T-SR-FAR-1-08-20-XX	1/2 / 13	0.020 / 0.51	\$ 37.96
T-SR-FAR-1-16-12-XX	1 / 25	0.012 / 0.30	\$ 37.96
T-SR-FAR-1-16-20-XX	1 / 25	0.020 / 0.51	\$ 43.96
FAR 25.853 Type II Tape (Other Widths / Thickness / Lengths Available)			
T-SR-FAR-2-16-20-XX	1 / 25	0.020 / 0.51	\$ 33.80
T-SR-FAR-2-16-30-XX	1 / 25	0.030 / 0.76	\$ 42.88
T-SR-FAR-2-16-40-XX	1 / 25	0.040 / 1.01	\$ 47.37

- Standard roll length is 36 feet / 12 Yards / 10.9 Metres; other lengths available.
- For the XX value (color code): OR = Oxide-Red, BK = Black



NSN & NATO Mil Spec Silicone Rubber Electrical Insulation Tapes
500°F / 260°C: FlameShield™ MIL Spec Silicone Rubber Self Fusing Compression & Stretch Tape with National Stock Number (NSN & NATO)
Meets MIL-I-46852 / A-A-59163 & Many Other Proprietary Specifications
Self Binding Self-Fusing Tape - High Temperature, Heat & Flame Resistant



- Self-bonds / self fuses / self amalgamating. No sticky residue or adhesive when removed. Starts fusing within minutes, fully bonded within hours. Excellent cold weather performance. Makes an excellent compression tape.
- Excellent for sealing ends of firesleeve: prevents sleeve from absorbing contamination and wicking liquids. Excellent for wrapping electrical & mechanical connections and splices. Makes clean and neat installations of cables, wires and hoses. Makes an instant separation bumper and provides vibration dampening. Secures insulation to hot air ducting.
- May meet Mil-I-46852, AA59163 and many proprietary specifications. Supplied with Certification.

Call for availability and pricing.

These tapes are not interchangeable. The NSN number specifies other parameters of the tape such as thickness, profile, width, reinforcement, rubber formulation, etc.



Some tapes are stock. Non stock items typically are 10 to 15 days to produce. Some may incur minimum order quantity (typically 18, 24, 30 or 36 rolls).

NSN / NATO National Stock Numbers

Color

Our Part Number

5970-00-082-3226	Black or Red	T-SR-NSN-00-082-3226
5970-00-177-1627	Black	T-SR-NSN-00-177-1627
5970-00-446-3928	Black	T-SR-NSN-00-446-3928
5970-00-446-8928	Red	T-SR-NSN-00-446-8928
5970-00-480-1329	Red	T-SR-NSN-00-480-1329
5970-00-782-5056	Red	T-SR-NSN-00-782-5056
5970-00-841-1172	Red	T-SR-NSN-00-841-1172
5970-00-949-4846	Red	T-SR-NSN-00-949-4846
5970-00-955-9976	Black	T-SR-NSN-00-955-9976
5970-01-140-5672	Red	T-SR-NSN-01-140-5672
5970-01-142-8454	Red	T-SR-NSN-01-142-8454
5970-01-147-3595	Red or Black	T-SR-NSN-01-147-3595
5970-01-250-8756	Red	T-SR-NSN-01-250-8756
5970-01-259-5830	Red or Black	T-SR-NSN-01-259-5830
5970-01-263-0373	Red	T-SR-NSN-01-263-0373
5970-01-263-3931	Black	T-SR-NSN-01-263-3931
5970-01-273-6030	Red or Black	T-SR-NSN-01-273-6030
5970-01-276-5277	Red or Black	T-SR-NSN-01-276-5277
5970-01-286-7456	Red	T-SR-NSN-01-286-7456
5970-01-342-8289	Black	T-SR-NSN-01-342-8289
5970-01-358-0397	Black or Red	T-SR-NSN-01-358-0397
5970-01-396-1601	Red	T-SR-NSN-01-396-1601
5970-01-432-6018	Red	T-SR-NSN-01-432-6018
5970-01-491-8992	Black	T-SR-NSN-01-491-8992
5970-01-495-5211	Black	T-SR-NSN-01-495-5211
5970-01-541-9092	Red or Black	T-SR-NSN-01-541-9092
9320-01-552-7024	Red or Black	T-SR-NSN-01-552-7024
5970-01-560-3208	Red or Black	T-SR-NSN-01-560-3208
8030-01-587-1885	Red	T-SR-NSN-01-587-1885
5970-01-600-6091	Red	T-SR-NSN-01-600-6091
5970-00-839-0824	Red	T-SR-NSN-00-839-0824
5970-14-459-8605	Black	T-SR-NSN-14-459-8605
5970-01-485-5980	Red or Black	T-SR-NSN-01-485-5980



TYT200-1 “No Heat” Silicone Rubber Self Fusing Waterproof Insulating Tape

500°F / 260°C: FlameShield™ - Meets MIL-I-46852 / A-A-59163 & Many Other Proprietary Specifications

Self Binding Self-Fusing Tape - High Temperature, Heat & Flame Resistant

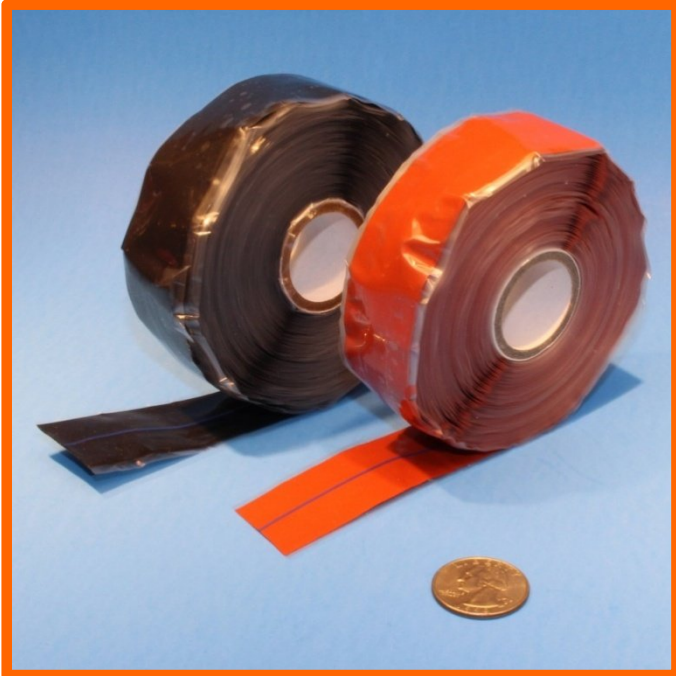

- Self-bonds / self fuses / self amalgamating. No sticky residue or adhesive when removed. Starts fusing within minutes, fully bonded within hours. Excellent cold temperature performance. Makes an excellent compression tape.
- Excellent for sealing ends of firesleeve: prevents sleeve from absorbing contamination and wicking liquids. Excellent for wrapping electrical & mechanical connections and splices. Makes clean and neat installations of cables, wires and hoses. Makes an instant separation bumper and provides vibration dampening. Secures insulation to hot air ducting.
- Meets Mil-I-46852, AA59163 and many proprietary specifications. Supplied with Certification.

FlameShield™ TYT200-1 ColeFlex “No Heat” Silicone Rubber Self Fusing Insulating Tape – Type I and Type II			
Part Number	Tape Width Inches / mm	Tape Thickness inches / mm	Price Per Roll Type I / Type II
TYT200-1 Type I & Type II			
T-SR-TYT200-1-36-X-YY	1 / 25	0.020 / 0.51	\$ 34.71 / \$ 33.80
T-SR-TYT200-1-14-X-ZZ	1 / 25	0.020 / 0.51	\$ 23.87 / \$ 22.80

- For the X value (Type): I = Type I; II = Type II
- For the YY value (color code): OR = Oxide-Red, BK = Black
- For the ZZ value (color code): OR = Oxide-Red, BK = Black, WH = White, BU = Blue, GR = Green, YL = Yellow
- T-SR-TYT200-1-36 is a stock item; T-SR-TYT200-1-14 minimum order 36 rolls

MOX 602 / MOX 603 / MOX 604 T Series MIL Spec Silicone Rubber Self Fusing Electrical Insulating Tape
500°F / 260°C: Meets MIL-I-46852 / A-A-59163 & Other Proprietary Specifications
Self Binding Self-Fusing Tape - High Temperature, Heat & Flame Resistant

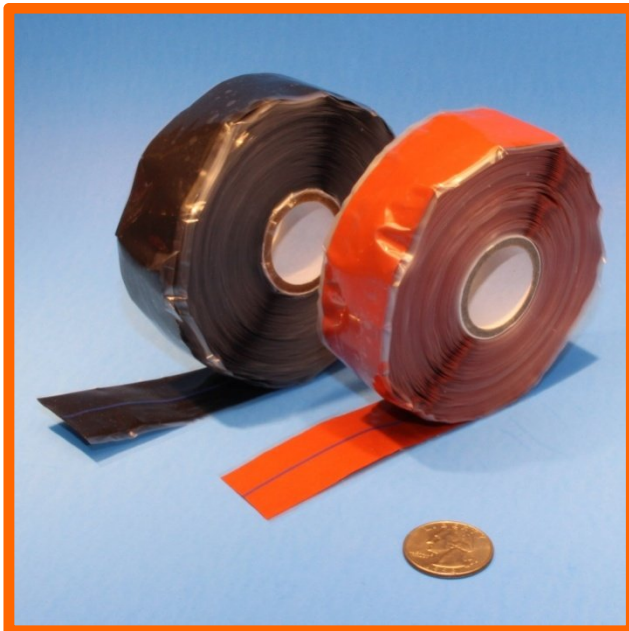

- Self-bonds / self fuses / self amalgamating. No sticky residue or adhesive when removed. Starts fusing within minutes, fully bonded within hours. Excellent cold weather performance. Makes an excellent compression tape.
- Excellent for sealing ends of firesleeve: prevents sleeve from absorbing contamination and wicking liquids. Excellent for wrapping electrical & mechanical connections and splices. Makes clean and neat installations of cables, wires and hoses. Makes an instant separation bumper and provides vibration dampening.
- Meets Mil-I-46852 and AA59163 specifications. Certification available.
- Standard roll length is 36 feet / 12 Yards / 10.9 Metres; other lengths available. For the XX value (color code): OR = Oxide-Red, BK = Black. Add \$6.00 for individual roll CofC. Lot/Batch CofC \$10.00 per order line item.

MOX 602 / MOX 603 / MOX 604 T Series MIL Spec High Temperature Silicone Self Fusing Electrical Insulating Tape - Meets MIL-I-46852 and A-A-59163 Specifications

Part Number	Tape Width Inches / mm	Thickness inches / mm	Type / Profile	Single Roll Price Per Roll
602 / 603 / 604 Mil-I-46852 / AA59163 Tapes: Type II				
T-SR-MOX-602-.50-TXX	1/2 / 13	0.020 / 0.50	II / Triangular	\$ 29.37
T-SR-MOX-602-.75-TXX	3/4 / 19	0.020 / 0.50	II / Triangular	\$ 31.96
T-SR-MOX-602-1.0-TXX	1 / 25	0.020 / 0.50	II / Triangular	\$ 33.80
T-SR-MOX-602-1.5-TXX	1 ½ / 38	0.020 / 0.50	II / Triangular	\$ 47.82
T-SR-MOX-603-.50-TXX	1/2 / 13	0.030 / 0.76	II / Triangular	\$ 32.31
T-SR-MOX-603-.75-TXX	3/4 / 19	0.030 / 0.76	II / Triangular	\$ 35.16
T-SR-MOX-603-1.0-TXX	1 / 25	0.030 / 0.76	II / Triangular	\$ 37.18
T-SR-MOX-603-1.5-TXX	1 ½ / 38	0.030 / 0.76	II / Triangular	\$ 52.60
T-SR-MOX-604-.50-TXX	1/2 / 13	0.040 / 1.0	II / Triangular	\$ 35.54
T-SR-MOX-604-.75-TXX	3/4 / 19	0.040 / 1.0	II / Triangular	\$ 38.68
T-SR-MOX-604-1.0-TXX	1 / 25	0.040 / 1.0	II / Triangular	\$ 40.90
T-SR-MOX-604-1.5-TXX	1 ½ / 38	0.040 / 1.0	II / Triangular	\$ 57.87

Please enquire for pricing on sizes other than those listed above.
This tape can be made in thicknesses from 0.010" to 0.080" and in various widths.

Amalgamating time: At 120°C; 120 minutes / at 150°C; 35 minutes / at 200°C; 20 minutes / at 250°C; 15 minutes

Tested for short duration fluid resistance: Jet Fuel (JP5), Hydraulic Fluid (Skydrol 500B4), Mineral Oil (NATO 0142), Synthetic Oil (NATO 0156), MIL-C-87836 & Foran 141B cleaning fluids, MIL-A-8243 cooling fluid.

Type II tapes have a center guideline stripe to assist in making 50% overwraps. The triangular profile version tape allows for minimal ridge lines, providing splices and joints with an almost totally smooth surface (prevents snagging when splice pulled through obstructions).



MOX 620 / MOX 630 / MOX 640 R Series MIL Spec Silicone Rubber Self Fusing Electrical Insulating Tape
500°F / 260°C: Meets MIL-I-46852 / A-A-59163 & Other Proprietary Specifications
Self Binding Self-Fusing Tape - High Temperature, Heat & Flame Resistant

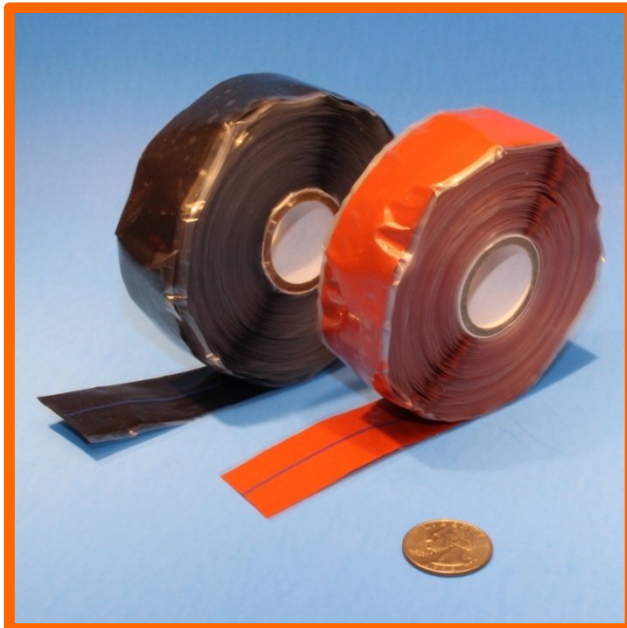

- Self-bonds / self fuses / self amalgamating. No sticky residue or adhesive when removed. Starts fusing within minutes, fully bonded within hours. Excellent cold weather performance. Makes an excellent compression tape.
- Excellent for sealing ends of firesleeve: prevents sleeve from absorbing contamination and wicking liquids. Excellent for wrapping electrical & mechanical connections and splices. Makes clean and neat installations of cables, wires and hoses. Makes an instant separation bumper and provides vibration dampening.
- Meets Mil-I-46852 and AA59163 specifications. Certification available.
- Standard roll length is 36 feet / 12 Yards / 10.9 Metres; other lengths available. For the XX value (color code): OR = Oxide-Red, BK = Black. Add \$6.00 for individual roll CofC. Lot/Batch CofC \$18.00 up to 10 rolls and \$25.00 up to 36 rolls.

MOX 620 / MOX 630 / MOX 640 R Series MIL Spec High Temperature Silicone Self Fusing Electrical Insulating Tape. Meets MIL-I-46852 and A-A-59163 Specifications				
Part Number	Tape Width Inches / mm	Thickness inches / mm	Type / Profile	Single Roll Price Per Roll
620 / 630 / 640 Mil-I-46852 / AA59163 Tapes: Type I				
T-SR-MOX-620-.50-RXX	1/2 / 13	0.020 / 0.50	I / Rectangular	\$ 29.87
T-SR-MOX-620-.75-RXX	3/4 / 19	0.020 / 0.50	I / Rectangular	\$ 32.76
T-SR-MOX-620-1.0-RXX	1 / 25	0.020 / 0.50	I / Rectangular	\$ 34.71
T-SR-MOX-620-1.5-RXX	1 ½ / 38	0.020 / 0.50	I / Rectangular	\$ 48.92
T-SR-MOX-630-.50-RXX	1/2 / 13	0.030 / 0.76	I / Rectangular	\$ 32.86
T-SR-MOX-630-.75-RXX	3/4 / 19	0.030 / 0.76	I / Rectangular	\$ 36.04
T-SR-MOX-630-1.0-RXX	1 / 25	0.030 / 0.76	I / Rectangular	\$ 38.18
T-SR-MOX-630-1.5-RXX	1 ½ / 38	0.030 / 0.76	I / Rectangular	\$ 53.81
T-SR-MOX-640-.50-RXX	1/2 / 13	0.040 / 1.0	I / Rectangular	\$ 36.15
T-SR-MOX-640-.75-RXX	3/4 / 19	0.040 / 1.0	I / Rectangular	\$ 39.64
T-SR-MOX-640-1.0-RXX	1 / 25	0.040 / 1.0	I / Rectangular	\$ 41.99
T-SR-MOX-640-1.5-RXX	1 ½ / 38	0.040 / 1.0	I / Rectangular	\$ 59.19

Please enquire for pricing on sizes other than those listed above.
This tape can be made in thicknesses from 0.010" to 0.080" and in various widths.

Amalgamating time: At 120°C; 120 minutes / at 150°C; 35 minutes / at 200°C; 20 minutes / at 250°C; 15 minutes

Tested for short duration fluid resistance: Jet Fuel (JP5), Hydraulic Fluid (Skydrol 500B4), Mineral Oil (NATO 0142), Synthetic Oil (NATO 0156), MIL-C-87836 & Foran 141B cleaning fluids, MIL-A-8243 cooling fluid.



66N / 67N / 68N / 69N / 78N / 79N Silicone Rubber Self Fusing Electrical Insulating Tape

500°F / 260°C: FlameShield™ Meets MIL-I-46852 / A-A-59163 / MIL-I-22444 & Many Other OEM Specifications

Self Binding Self-Fusing Tape - High Temperature, Heat & Flame Resistant



- Self-bonds / self fuses / self amalgamating. No sticky residue or adhesive when removed. Starts fusing within minutes, fully bonded within hours. Excellent cold temperature performance. Makes an excellent compression tape.
- Excellent for sealing ends of firesleeve: prevents sleeve from absorbing contamination and wicking liquids. Excellent for wrapping electrical & mechanical connections and splices. Makes clean and neat installations of cables, wires and hoses. Makes an instant separation bumper and provides vibration dampening. Secures insulation to hot air ducting.
- Unsupported tape meets Mil-I-46852, AA59163 and many other specifications. Supported tape meets MIL-I-22444 and many other specifications.
- Certification available.

- T-SR-66N-5970-14-467-8824 meets NATO/NSN 5970-14-467-8824 and ABS 5334 specification. Oxide-Red / Red-Brown Color. T-SR-67N-5970-14-474-7041 meets NATO/NSN 5970-14-474-7041 and ABS 5334 specification. Black Color. T-SR-SB15-68N-5970-14-464-7312 meets NATO/NSN 5970-14-464-7312 and ASNA 5107 specification. Oxide-Red / Red-Brown Color.

FlameShield™ 66N / 67N / 68N / 69N / 78N / 79N Silicone Rubber Self Fusing Electrical Insulation Tape			
Part Number	Tape Width Inches / mm	Tape Thickness inches / mm	Price Per Roll
Unsupported Tape – No Fiberglass Substrate – 300% to 500% Elongation			
T-SR-66N-5970-14-467-8824-OR	0.75 / 19	0.012 / 0.30	\$ 24.64
T-SR-67N-5970-14-474-7041-BK	0.75 / 19	0.020 / 0.51	\$ 26.80
Supported Tape – With Fiberglass Substrate – 15% Maximum Elongation			
T-SR-SB15-68N-5970-14-464-7312-OR	0.75 / 19	0.012 / 0.30	\$ 61.37
T-SR-SB15-69N-BK	0.75 / 19	0.020 / 0.51	\$ 64.82
T-SR-SB15-78N-OR	1.00 / 25	0.020 / 0.51	\$ 67.29
T-SR-SB15-79N-BK	1.00 / 25	0.020 / 0.51	\$ 67.29

Amalgamating time: At 120°C; 120 minutes / at 150°C; 35 minutes / at 200°C; 20 minutes / at 250°C; 15 minutes

Tested for short duration fluid resistance: Jet Fuel (JP5), Hydraulic Fluid (Skydrol 500B4), Mineral Oil (NATO 0142), Synthetic Oil (NATO 0156), MIL-C-87836 & Foran 141B cleaning fluids, MIL-A-8243 cooling fluid.



RL6000SA & RL6000SB Stretchtape™ Equivalent
Silicone Rubber Self Fusing Electrical Insulating Tape
500°F / 260°C: Meets MIL-I-22444, MIL-I-46852 / A-A-59163 & Many Other OEM
Specifications

Self Binding Self-Fusing Tape - High Temperature, Heat & Flame Resistant



- Self-bonds / self fuses / self amalgamating. No sticky residue or adhesive when removed. Starts fusing within minutes, fully bonded within hours. Excellent cold temperature performance. Makes an excellent compression tape.
- Excellent for sealing ends of firesleeve: prevents sleeve from absorbing contamination and wicking liquids. Excellent for wrapping electrical & mechanical connections and splices. Makes clean and neat installations of cables, wires and hoses. Makes an instant separation bumper and provides vibration dampening. Secures insulation to hot air ducting.
- Supported tape meets MIL-I-22444 and many other specifications.
- Certification available.
- Rolls are 12 yards long

RL6000SA & RL6000SB Stretchtape™ Equivalent			
Silicone Rubber Self Fusing Electrical Insulating Tape			
Part Number	Tape Width Inches / mm	Tape Thickness inches / mm	Price Per Roll
Supported Tape – With Fiberglass Substrate – 15% and 25% Maximum Elongation			
T-SR-RL6000SA-XX	1.00 / 25	0.020 / 0.51	\$ 67.29
T-SR-RL6000SB-XX	1.00 / 25	0.020 / 0.51	\$ 67.29

- For the XX value (color code): OR = Oxide-Red, BK = Black

T-SR-RL6000SA-XX equivalent to NSN 5970-01-325-8971

T-SR-RL6000SB-XX equivalent to NSN 5970-00-841-1172

Amalgamating time: At 120°C; 120 minutes / at 150°C; 35 minutes / at 200°C; 20 minutes / at 250°C; 15 minutes

Stretchtape™ is a trademark of Kirkhill-TA / Esterline

ABS5334A01B & ABS5334A02R Silicone Rubber Self Fusing Electrical Insulating Tape

500°F / 260°C: FlameShield™ Meets MIL-I-46852 / A-A-59163 & Many Other OEM Specifications

Self Binding Self-Fusing Tape - High Temperature, Heat & Flame Resistant

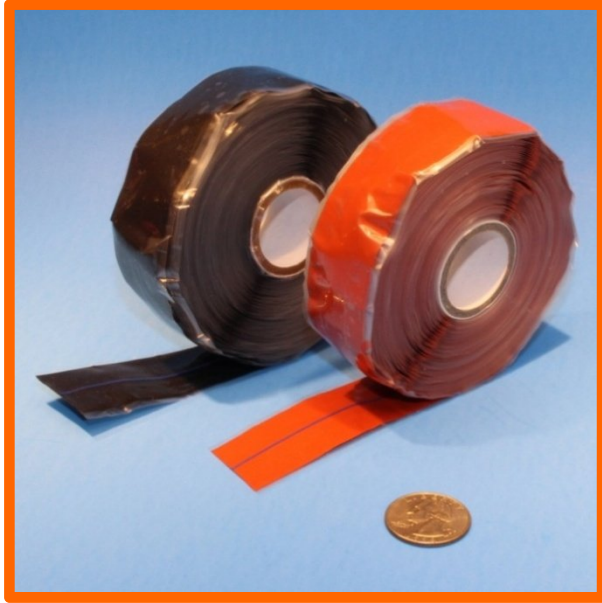

- Self-bonds / self fuses / self amalgamating. No sticky residue or adhesive when removed. Starts fusing within minutes, fully bonded within hours. Excellent cold temperature performance. Makes an excellent compression tape.
- Excellent for sealing ends of firesleeve: prevents sleeve from absorbing contamination and wicking liquids. Excellent for wrapping electrical & mechanical connections and splices. Makes clean and neat installations of cables, wires and hoses. Makes an instant separation bumper and provides vibration dampening. Secures insulation to hot air ducting.
- Unsupported tape meets Mil-I-46852, AA59163 and many other specifications.
- Certification available.

FlameShield™ ABS5334A01B & ABS5334A02R Silicone Rubber Self Fusing Electrical Insulation Tape			
Part Number	Tape Width Inches / mm	Tape Thickness inches / mm	Price Per Roll
T-SR-ABS5334A02R-66N-ROR	0.75 / 19	0.012 / 0.30	\$ 24.64
T-SR-ABS5334A01B-67N-RBK	0.75 / 19	0.020 / 0.51	\$ 26.80

Amalgamating time: At 120°C; 120 minutes / at 150°C; 35 minutes / at 200°C; 20 minutes / at 250°C; 15 minutes

Tested for short duration fluid resistance: Jet Fuel (JP5), Hydraulic Fluid (Skydrol 500B4), Mineral Oil (NATO 0142), Synthetic Oil (NATO 0156), MIL-C-87836 & Foran 141B cleaning fluids, MIL-A-8243 cooling fluid.

Eaton Weatherhead® A6900W equivalent Silicone Elastomer Tape
Meets MIL-I-46852 / A-A-59163 & Many Other Proprietary Specifications
Self Binding Self-Fusing Tape - High Temperature, Heat & Flame Resistant

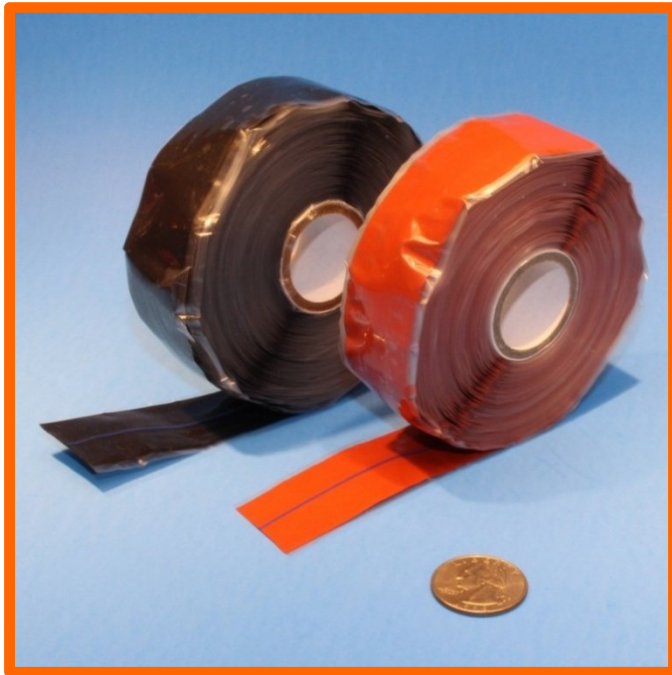

- Self-bonds / self fuses / self amalgamating. No sticky residue or adhesive when removed. Starts fusing within minutes, fully bonded within hours. Excellent cold temperature performance. Makes an excellent compression tape.
- Excellent for sealing ends of firesleeve: prevents sleeve from absorbing contamination and wicking liquids. Excellent for wrapping electrical & mechanical connections and splices. Makes clean and neat installations of cables, wires and hoses. Makes an instant separation bumper and provides vibration dampening. Secures insulation to hot air ducting.
- Meets Mil-I-46852 and AA59163 specifications. Certification Available.

Eaton Weatherhead® A6900W Equivalent Silicone Rubber Self Fusing Insulating Tape			
Part Number	Tape Width Inches / mm	Tape Length, inches / yards	Price Per Roll
T-SR-A6900W-OR	1 / 25	432 / 12	\$ 33.80
T-SR-A6900W-BK	1 / 25	432 / 12	\$ 33.80

- OR = Oxide-Red, BK = Black

Weatherhead® is a registered trademark of Eaton Hydraulics

Simrit® – Freudenberg-NOK Equivalent Silicone Tape – Type I & Type II
500°F / 260°C: MIL Spec Silicone Rubber Self Fusing Electrical Insulating Tape
Meets MIL-I-46852 / A-A-59163 & Many Other Proprietary Specifications
Self Binding Self-Fusing Tape - High Temperature, Heat & Flame Resistant

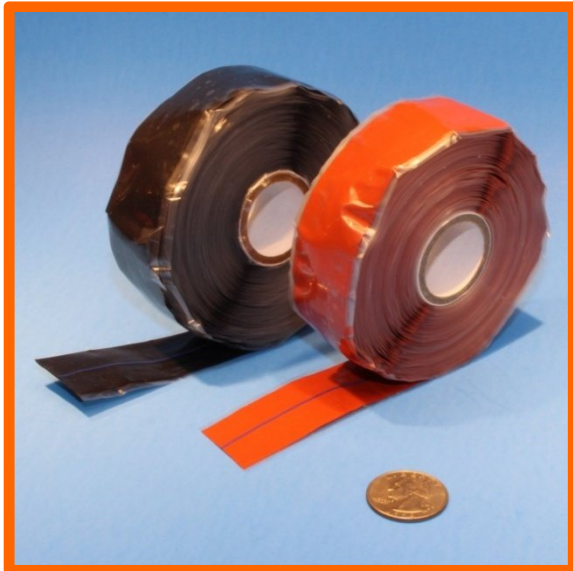

- Self-bonds / self fuses / self amalgamating. No sticky residue or adhesive when removed. Starts fusing within minutes, fully bonded within hours. Excellent cold weather performance. Makes an excellent compression tape.
- Excellent for sealing ends of firesleeve; prevents sleeve from absorbing contamination and wicking liquids. Excellent for wrapping electrical & mechanical connections and splices. Makes clean and neat installations of cables, wires and hoses. Makes an instant separation bumper and provides vibration dampening.
- Meets Mil-I-46852 and AA59163 specifications. Certification available.
- Standard roll length is 36 feet / 12 Yards / 10.9 Metres; other lengths available. For the XX value (color code): OR = Oxide-Red, BK = Black. For the "Z" Value: Substitute "CT" for Certified Tape or "NC" for Not Certified. Add \$6.00 for individual roll CofC. Lot/Batch CofC \$10.00 per order line item.

Simrit® Equivalent Silicone Tapes				
Meets MIL-I-46852 / A-A-59163 Specifications Type I & Type II				
Part Number	Tape Width Inches / mm	Thickness inches / mm	Type / Profile	Single Roll Price Per Roll
Mil-I-46852 / AA59163 Tapes: Type I				
T-SR-SIMRIT-56756	1 / 25	0.012 / 0.5	I / Rectangular	\$ Call
T-SR-SIMRIT-57063	3/4 / 19	0.015 / 0.5	I / Rectangular	\$ Call
T-SR-SIMRIT-57090	1 / 25	0.015 / 0.5	I / Rectangular	\$ Call
T-SR-SIMRIT-50005	1 ½ / 38	0.020 / 0.5	I / Rectangular	\$ Call
T-SR-SIMRIT-50006	2 / 51	0.020 / 0.5	I / Rectangular	\$ Call
T-SR-SIMRIT-57161	1 / 25	0.020 / 0.5	I / Rectangular	\$ Call
T-SR-SIMRIT-50022	1 1/4 / 38	0.020 / 0.5	I / Rectangular	\$ Call
T-SR-SIMRIT-50039	1/2 / 13	0.030 / 0.76	I / Rectangular	\$ Call
T-SR-SIMRIT-57806	1 / 25	0.030 / 0.76	I / Rectangular	\$ Call
Mil-I-46852 / AA59163 Tapes: Type II				
T-SR-SIMRIT-50014	1 / 25	0.020 / 0.5	II / Triangular	\$ Call
T-SR-SIMRIT-50215	1 / 25	0.030 / 0.76	II / Triangular	\$ Call
T-SR-SIMRIT-50361	1 / 25	0.040 / 0.76	II / Triangular	\$ Call
T-SR-SIMRIT-53304	1 1/4 / 38	0.040 / 0.76	II / Triangular	\$ Call
T-SR-SIMRIT-50573	1 1/4 / 38	0.050 / 0.76	II / Triangular	\$ Call
T-SR-SIMRIT-56517	1 ½ / 38	0.050 / 0.76	II / Triangular	\$ Call
T-SR-SIMRIT-56265	1 ½ / 38	0.060 / 0.76	II / Triangular	\$ Call

Amalgamating time: At 120°C; 120 minutes / at 150°C; 35 minutes / at 200°C; 20 minutes / at 250°C; 15 minutes

Simrit® is a registered trademark of Freudenberg NOK

Simrit® – Freudenberg-NOK Equivalent Silicone Rubber Tape – Reinforced & Controlled Elongation

500°F / 260°C: MIL Spec Silicone Rubber Self Fusing Electrical Insulating Tape
 Meets MIL-I-22444, MIL-I-46852 / A-A-59163 & Many Other OEM Specifications
 Self Binding Self-Fusing Tape - High Temperature, Heat & Flame Resistant

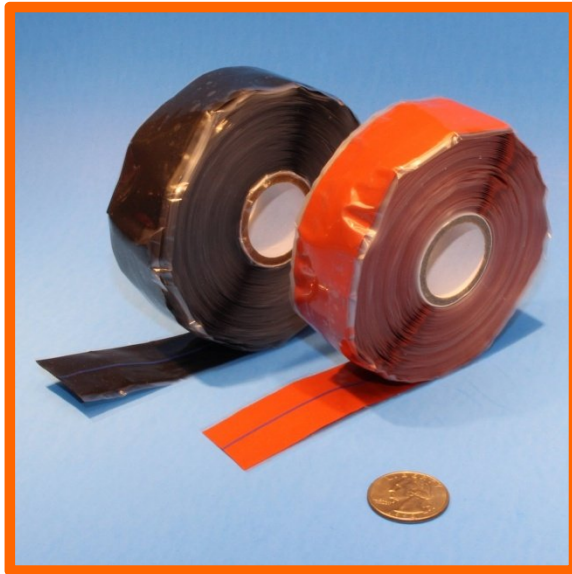

- Self-bonds / self fuses / self amalgamating. No sticky residue or adhesive when removed. Starts fusing within minutes, fully bonded within hours. Excellent cold weather performance. Makes an excellent compression tape.
- Excellent for sealing ends of firesleeve: prevents sleeve from absorbing contamination and wicking liquids. Excellent for wrapping electrical & mechanical connections and splices. Makes clean and neat installations of cables, wires and hoses. Makes an instant separation bumper and provides vibration dampening.
- Meets Mil-I-46852 and AA59163 specifications. Certification available.
- Standard roll length is 36 feet / 12 Yards / 10.9 Metres; other lengths available. For the XX value (color code): OR = Oxide-Red, BK = Black. For the "Z" Value: Substitute "CT" for Certified Tape or "NC" for Not Certified. Add \$6.00 for individual roll CofC. Lot/Batch CofC \$10.00 per order line item.

Simrit® Equivalent Silicone Tapes – Reinforced Controlled Elongation Tape Meets MIL-I-22444, MIL-I-46852 / A-A-59163 Specifications: Type I Supported				
Part Number	Tape Width Inches / mm	Thickness inches / mm	Type / Profile	Single Roll Price Per Roll
Mil-I-22444 Reinforced Controlled Elongation Tape				
T-SR-SIMRIT-22444-58609	1 / 25	0.015 / 0.5	I / Rectangular	\$ Call
T-SR-SIMRIT-22444-58607	1 / 25	0.015 / 0.5	I / Rectangular	\$ Call
T-SR-SIMRIT-22444-58613	1/2 / 13	0.020 / 0.5	I / Rectangular	\$ Call
T-SR-SIMRIT-22444-58611	1/2 / 13	0.020 / 0.5	I / Rectangular	\$ Call
T-SR-SIMRIT-22444-58615	1 / 25	0.020 / 0.5	I / Rectangular	\$ Call
T-SR-SIMRIT-22444-58617	1 / 25	0.020 / 0.5	I / Rectangular	\$ Call
T-SR-SIMRIT-22444-58621	1 / 25	0.050 / 0.76	I / Rectangular	\$ Call
T-SR-SIMRIT-22444-58619	1 / 25	0.050 / 0.76	I / Rectangular	\$ Call

Amalgamating time: At 120°C; 120 minutes / at 150°C; 35 minutes / at 200°C; 20 minutes / at 250°C; 15 minutes

Simrit® is a registered trademark of Freudenberg NOK

**L-3 Communications Tape, Electrical,
Silicone Self-Fusing, Non-Reinforced**
500°F / 260°C: Meeting A-A-59163 Class 1, Type I Specifications
Also meets MIL-I-46852 & Many Other OEM Specifications
Self Binding Self-Fusing Tape - High Temperature, Heat & Flame Resistant

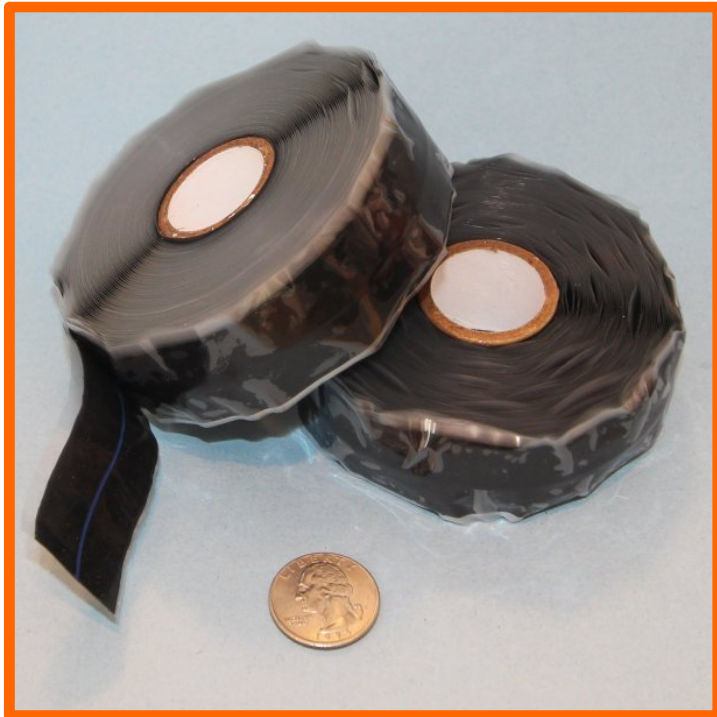

- Self-bonds / self fuses / self amalgamating. No sticky residue or adhesive when removed. Starts fusing within minutes, fully bonded within hours. Excellent cold weather performance. Makes an excellent compression tape.
- Excellent for sealing ends of firesleeve: prevents sleeve from absorbing contamination and wicking liquids. Excellent for wrapping electrical & mechanical connections and splices. Makes clean and neat installations of cables, wires and hoses. Makes an instant separation bumper and provides vibration dampening.
- Meets A-A-59163 specifications. Certification available.
- Standard roll length is 36 feet / 12 Yards / 10.9 Metres; other lengths available. Color is Black.
- Add \$6.00 for individual roll CofC. Lot/Batch CofC \$10.00 per order line item.
- Cage Code L8347.

L-3 Communications Tape, Electrical, Silicone Self-Fusing, Non-Reinforced				
Meets A-A-59163 Specifications: Class 1, Type I				
Part Number	Tape Width Inches / mm	Thickness inches / mm	Type / Profile	Single Roll Price Per Roll
T-SR-40014362-000	1/2 / 13	0.020 / 0.5	I / Rectangular	\$ 29.37
T-SR-40014362-001	3/4 / 19	0.020 / 0.5	I / Rectangular	\$ 31.96
T-SR-40014362-002	1 / 25	0.020 / 0.5	I / Rectangular	\$ 34.71
T-SR-40014362-003	1.25 / 32	0.020 / 0.5	I / Rectangular	\$ 41.77

3M™ Scotch® 70 Equivalent Silicone Rubber Electrical Tape
356°F / 180°C: FlameShield™ Meets A-A-59163 & Many Other Proprietary OEM Specifications
Self Binding Self-Fusing Tape - High Temperature, Heat & Flame Resistant

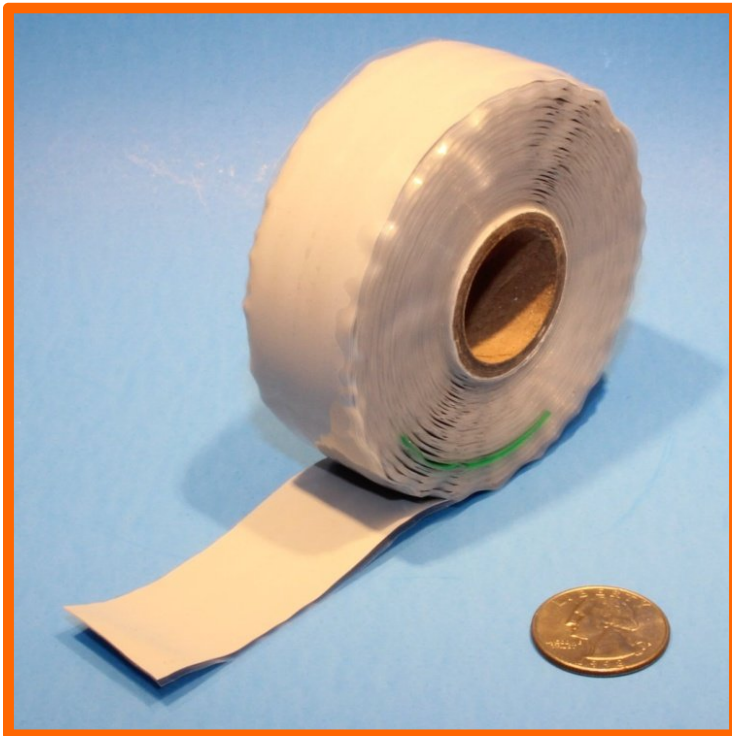

- Self-bonds / self fuses / self amalgamating. No sticky residue or adhesive when removed. Starts fusing within minutes, fully bonded within hours. Excellent cold weather performance. Makes an excellent compression tape.
- Excellent for wrapping electrical & mechanical connections and splices. Makes clean and neat installations of cables, wires and hoses. Makes an instant separation bumper and provides vibration dampening.
- Meets AA59163 specifications. Certification available.
- Arc and Track Resistant.
- RoHS compliant.
- Roll length is 30 feet.

FlameShield™ High Temperature Silicone Self Fusing Compression/Stretch Tape Equivalent to 3M™ Scotch® 70 Meets A-A-59163 Specifications					
Part Number	Tape Width Inches / mm	Thickness inches / mm	Profile	Color	Single Roll Price Per Roll
T-SR-70	1 / 25	0.012 / 0.30	Rectangular	Blue-Grey	\$ 27.80

Quantity discounts available – 24 rolls per case

Please enquire for pricing on sizes other than those listed above.
This tape can be made in thicknesses from 0.010” to 0.080” and in various widths.

- Add \$6.00 for individual roll CofC. Lot/Batch CofC \$10.00 per order line item

3M ID 80611438617 UPC# 00051128572610 3M Product Number 70-1x30FT

Triangular tapes have a center guideline stripe to assist in making 50% overwraps. The triangular profile version tape allows for minimal ridge lines, providing splices and joints with an almost totally smooth surface (prevents snagging when splice pulled through obstructions).

Scotch® is a registered trademark of the 3M company

GE and EMD Coil Winding Encapsulating Tape – Semi Cured & Uncured Bonding Layers

500°F / 260°C: FlameShield™ Silicone Rubber Meets GE and EMD specifications for traction motors: Many others available

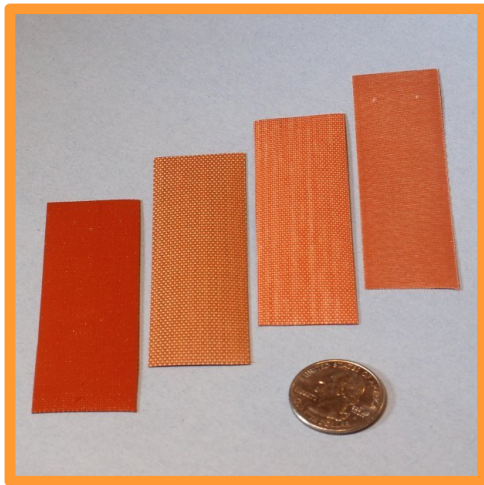

- Available with several construction options:
 - 1) A fibreglass substrate with cured silicone rubber on both sides (one side has a thinner coating layer), with an additional uncured layer on top of the cured layer on one side. Has an interleave.
 - 2) A fibreglass substrate with semi-cured silicone rubber on one side. No interleave.
- Curing: most require a cure cycle of 350F at 50psi for 15 minutes. Post Cure Cycle: 2 to 3 hours at 375-410F. See specific tape data for its curing instructions.
- Supplied with Certification to OEM specification.
- Product is produced as a 36" wide log, from which the tape widths are slit. Typical tape widths are 0.75, 1.00, 1.25 and 1.5". Any other width is available. Complete logs available.
- Photo shows a few of the different versions of available tape, with different substrates weave sizes visible through the thin side coating.

FlameShield™ Coil Winding Encapsulating Tape			
Part Number	OEM Part Number	Tape Thickness Inches / mm	Price Per Roll (Depends on Width)
T-SRUC-84	GE 84A210606P154 GE 84A210606P157	0.020 / 0.51	By Quote
T-SRUC-41	GE 41A239176P70 GE 41A239176P71	0.015 / 0.38	By Quote
T-SRUC-82	EMD 8205562 EMD 8227441 EMD R718024	0.015 / 0.38	By Quote
T-SRUC-71	EMD R718051 / EMD R718077 EMD 8220410 / EMD 40100391 EMD 8257527	0.020 / 0.51	By Quote
T-SRUC-21	GE 21261	0.020 / 0.51	By Quote
T-SRUC-158	GE 84A210606P158	0.011 / 0.28	By Quote

- Standard roll length is 36 feet / 12 Yards / 10.9 Metres; other lengths available.
- All versions are Oxide-Red

These tapes are also used to form various flexible structures such as ducting. They can be wrapped over forms and then cured.

PipeSeal™ Silicone Rubber Self Fusing Compression & Stretch Leak Sealing Tape

Self-Binding Self-Fusing Tape

Superior method of making drain pipe repairs and septic tank inlet pipe leak repair

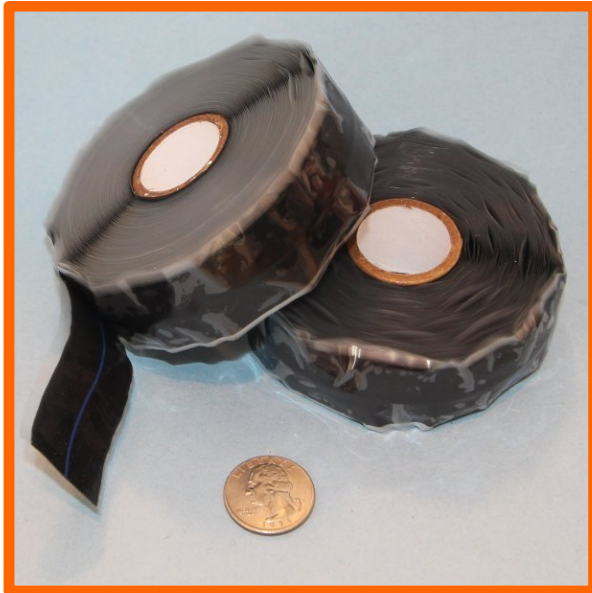

- Makes a watertight seal that prevents leaks on drain pipe defects.
- Wide temperature range from -50 to +500F
- Makes Septic Tank Pipe Leak repair quick and easy.
- One roll will wrap ten 4" pipe connections.
- Saves time and money by preventing the need to disassemble pipe assembly.
- Widely used on Septic Tank Inlet Pipe joints and elbows. Many older septic installations did not originally glue the pipes, allowing seepage of the septic liquid into the ground and in contact with basement walls and floor slabs – resulting in a sewer gas smell in the home.



LeakSeal™ Drain Pipe Leak Repair Tape

Part Number	Tape Width Inches / mm	Tape Thickness	Price Per Roll
T-SR-LeakSeal	1 ½" / 39	.020	\$ 48.77

- Standard roll length is 36 feet / 12 Yards / 10.9 Metres; other lengths available.
- This tape is available Black or Oxide-Red.

Sealing Tape for Stovepipe and Stainless Steel Flue Gas Duct

DuctSeal™ Silicone Rubber Self Fusing Leak Sealing Tape

Self-Binding Self-Fusing Tape

Helps to reduce combustion smells by sealing the seams of round duct work on wood stoves, pellet stoves, propane and natural gas stoves and bio-fuel stoves



- Seals the seams on combustion stove pipe, reduces the smell due to leakage of exhaust flue gas.
- Easy to apply and remove.
- No sticky glue to create a mess and gum up parts.
- Available in Oxide-red or Black.
- Can be applied to hot or cold pipe.
- Wide temperature range from -50 to +500F.
- Popular for use on Simpson M&G DuraVent® and PelletVent® pipe.



DuctSeal™ Stove Pipe Seam Sealing Tape			
Part Number	Tape Width Inches / mm	Tape Thickness	Price Per Roll
T-SR-DuctSeal	1" / 25	.020	\$ 33.80

- Standard roll length is 36 feet / 12 Yards / 10.9 Metres; other lengths available.
- This tape is available Black or Oxide-Red.

Fiberglass Gasket Seal Tape with PTFE Coating: Premium Grade 550°F / 287°C: Tuff-Flex™ High Temperature, Heat & Chemical Resistance



- An excellent gasket tape providing sealing against a variety of gases and liquids: Excellent chemical resistance.
- Available in three thicknesses.
- PTFE Sintered Coating.

This tape offers the advantage of a non-asbestos material with higher temperature range and with excellent resistance to almost all solvents, caustics and acids. The base fabric is rated to 1000°F / 537°C. PTFE melting point is 620°F / 327°C.

Offered in Plain and Drop Warp (also known as Bolt-Hole or Ladder Tape).

550°F / 287°C continuous rating

High Temperature, Heat & Chemical Resistance Fiberglass Gasket Tape with PTFE Coating: Premium Tape					
Part Number	Width in / mm		Price per Roll By Thickness: A / B / C		
			"A" thickness 1/16" .0625"/1.59mm	"B" thickness 1/8" .125"/3.18mm	"C" thickness 1/4" .250"/6.35mm
T-FG-WOVEN-PTFE-P-M013-08-X-Z**	.5	13	\$ 61.13	\$ 94.93	NA
T-FG-WOVEN-PTFE-P-M019-12-X-Z**	.75	19	\$ 65.27	\$ 105.33	\$ 199.93
T-FG-WOVEN-PTFE-P-M025-16-X-Z	1.0	25	\$ 105.27	\$ 165.80	\$ 305.63
T-FG-WOVEN-PTFE-P-M032-20-X-Z	1.25	32	\$ 148.40	\$ 229.83	\$ 405.33
T-FG-WOVEN-PTFE-P-M038-24-X-Z	1.5	38	\$ 191.53	\$ 293.70	\$ 505.03
T-FG-WOVEN-PTFE-P-M051-32-X-Z	2.0	51	\$ 241.93	\$ 372.20	\$ 634.07
T-FG-WOVEN-PTFE-P-M064-40-X-Z	2.5	64	\$ 292.33	\$ 452.80	\$ 736.73
T-FG-WOVEN-PTFE-P-M076-48-X-Z	3.0	76	\$ 342.60	\$ 532.33	\$ 900.27
T-FG-WOVEN-PTFE-P-M089-56-X-Z	3.5	89	\$ 392.93	\$ 611.73	\$ 1041.37*
T-FG-WOVEN-PTFE-P-M102-64-X-Z	4.0	102	\$ 443.13	\$ 691.07	\$ 1179.93
T-FG-WOVEN-PTFE-P-M127-80-X-Z	5.0	127	\$ 557.27	\$ 863.53	\$ 1458.53*
T-FG-WOVEN-PTFE-P-M152-96-X-Z	6.0	152	\$ 658.27	\$ 1035.67	\$ 1776.60

- For the "X" value, specify "A", "B" or "C" in the part number to correspond to the desired thickness. A = 1/16" / .0625" / 1.59mm B = 1/8" / .125" / 3.18mm C = 1/4" / .250" / 6.35mm
- For the "Z" value in part number: use "-P" for Plain style tape or "-DW" for Drop Warp style tape
- All tapes are 100 foot lengths.
- Items with * may have higher minimum order quantities – please call.
- ** .5" / 13mm and .75" / 19mm width tapes are not available in Drop Warp

The PTFE is applied to the tape by proprietary sinterization process. The result is a PTFE coating on the tape which is soft, robust and flexible; however, it can be abrasively removed from the tape with aggressive fingernail scraping, resulting in a thinner and thinner layer of PTFE remaining with each pass. The PTFE also causes the yarns to be sealed and the small gaps between the yarns filled, resulting in an almost air-tight / liquid-tight tape.

Fiberglass Gasket Seal Tape with PTFE Coating: Industrial Grade 550°F / 287°C: Tuff-Flex™ High Temperature, Heat & Chemical Resistance



- An excellent gasket tape providing sealing against a variety of gases and liquids: Excellent chemical resistance.
- Available in two thicknesses.
- PTFE Sintered Coating

This tape offers the advantage of a non-asbestos material with higher temperature range and with excellent resistance to almost all solvents, caustics and acids. The base fabric is rated to 1000°F / 537°C. PTFE melting point is 620°F / 327°C.

Offered in Plain and Drop Warp (*also known as Bolt-Hole or Ladder Tape*).

550°F / 287°C continuous rating

High Temperature, Heat & Chemical Resistance Fiberglass Gasket Tape with PTFE Coating: Industrial Tape				
Part Number	Width in / mm		Price per Roll By Thickness: A / B	
			"A" thickness 1/16" .0625"/1.59mm	"B" thickness 1/8" .125"/3.18mm
T-FG-WOVEN-PTFE-I-M013-08-X-Z**	.5	13	\$ 216.33** / #	\$ 149.20**
T-FG-WOVEN-PTFE-I-M019-12-X-Z**	.75	19	\$ 83.47**	\$ 244.60 ** / ***
T-FG-WOVEN-PTFE-I-M025-16-X-Z	1.0	25	\$ 95.73	\$ 154.40
T-FG-WOVEN-PTFE-I-M032-20-X-Z	1.25	32	\$ 115.07	\$ 175.20
T-FG-WOVEN-PTFE-I-M038-24-X-Z	1.5	38	\$ 119.20	\$ 181.60
T-FG-WOVEN-PTFE-I-M051-32-X-Z	2.0	51	\$ 137.33	\$ 202.00
T-FG-WOVEN-PTFE-I-M064-40-X-Z	2.5	64	\$ 194.53	\$ 261.40
T-FG-WOVEN-PTFE-I-M076-48-X-Z	3.0	76	\$ 214.80	\$ 265.47
T-FG-WOVEN-PTFE-I-M089-56-X-Z	3.5	89	\$ 233.20	\$ 294.00
T-FG-WOVEN-PTFE-I-M102-64-X-Z	4.0	102	\$ 255.33	\$ 322.40
T-FG-WOVEN-PTFE-I-M127-80-X-Z	5.0	127	\$ 319.20	\$ 375.60
T-FG-WOVEN-PTFE-I-M152-96-X-Z	6.0	152	\$ 334.13	\$ 434.40

- For the "X" value specify "A" or "B" in the part number to correspond to the desired thickness
 A = 1/16" / .0625" / 1.59mm B = 1/8" / .125" / 3.18mm
- For the "Z" value in part number: use "-P" for Plain style tape or "-DW" for Drop Warp style tape
- All tapes are 100 foot lengths.
- Items with * may have higher minimum order quantities – please call.
- ** .5" / 13mm and .75" / 19mm width tapes are not available in Drop Warp. *** 200 ft long
- # .5" / 13mm wide x 1/16" thick tape is 500 ft roll length

The PTFE is applied to the tape by proprietary sinterization process. The result is a PTFE coating on the tape which is soft, robust and flexible; however, it can be abrasively removed from the tape with aggressive fingernail scraping, resulting in a thinner and thinner layer of PTFE remaining with each pass. The PTFE also causes the yarns to be sealed and the small gaps between the yarns filled, resulting in an almost air-tight / liquid-tight tape.

Fiberglass Tape with PTFE Resin Impregnation & Self Adhesive 500°F / 260°C: Tuff-Flex™ High Temperature & Chemical Resistant with Smooth Non-Stick Surface - Premium Grade



- This tape is made by slitting our PTFE resin impregnated fiberglass fabric. Available with and without backing media on the adhesive side. Available with Acrylic or Silicone adhesive.
- Provides excellent chemical resistance and superior electrical insulation. Used as a low friction release tape for heat sealing bars and other packaging applications.
- Used on various machinery parts to provide a smooth stick-free surface such as on production line runners and guides for easy product and parts conveyance.
- Used as an electrical tape for high insulation and high temperature performance.
- Premium Grade is an exceptionally smooth surface with a higher PTFE content than Industrial Grade.
- Temperature range: Silicone adhesive tape -100°F to +500°F (-73°C to +260°C). Acrylic adhesive tapes -40°F to +350°F (-40°C to +177°C).

Tuff-Flex™ High Temperature, Heat & Chemical Resistant Fiberglass Tape with PTFE Resin Impregnation & Self Adhesive: Premium Grade

Part Number	Width in / mm		Price per Roll by Thickness Silicone or Acrylic Adhesive (thickness measurement does not include adhesive)			
			X = 3 .003" Dielectric S = 5 kV / A = 4.5 kV	X = 5 .005" Dielectric S = 7.5 kV / A = 7 kV	X = 6 .006" Dielectric S = 8.5 kV / A = 8.5 kV	X = 10 .010" Dielectric S = 9.5 kV / A = 9 kV
T-FG-PTRI-P-M013-08-X-Y-Z	.5	13	\$ 28.26 *	\$ 39.71 *	\$ 45.07 *	\$ 53.03 *
T-FG-PTRI-P-M019-12-X-Y-Z	.75	19	\$ 42.40 *	\$ 59.57 *	\$ 67.61 *	\$ 79.55 *
T-FG-PTRI-P-M025-16-X-Y-Z	1.0	25	\$ 56.52 *	\$ 79.42 *	\$ 90.14	\$ 106.06
T-FG-PTRI-P-M032-20-X-Y-Z	1.25	32	\$ 70.66	\$ 99.28	\$ 112.68	\$ 132.58
T-FG-PTRI-P-M038-24-X-Y-Z	1.5	38	\$ 84.78	\$ 119.12	\$ 135.22	\$ 159.08
T-FG-PTRI-P-M051-32-X-Y-Z	2.0	51	\$ 113.04	\$ 158.83	\$ 180.29	\$ 212.11
T-FG-PTRI-P-M064-40-X-Y-Z	2.5	64	\$ 141.30	\$ 198.54	\$ 225.36	\$ 265.14
T-FG-PTRI-P-M076-48-X-Y-Z	3.0	76	\$ 169.56	\$ 238.25	\$ 270.43	\$ 318.17
Other Widths			\$ 56.52 / in	\$ 79.42 / in	\$ 90.14 / in	\$ 106.06 / in
Tensile Strength Warp / Fill (lbs/in)	Silicone		95 / 55	140 / 130	150 / 115	325 / 235
	Acrylic		95 / 55	125 / 130	150 / 150	325 / 235
Tear Strength Warp / Fill (lbs)	Silicone		1.5 / 0.9	2.2 / 1.7	2.1 / 1.8	7.5 / 4.0
	Acrylic		1.5 / 0.9	1.8 / 1.7	2.1 / 1.7	7.5 / 4.0

* NOTE: Minimum order for indicated tapes is 2 rolls Custom slitting available up to a maximum of 36 inches.

- For the "X" value in the part number, use "3" for .003, "5" for .005, "6" for .006, "10" for .010, "14" for .014
- For the "Y" value specify "A" or "S" in the part number to correspond to the desired adhesive
A = Acrylic S = Silicone
- For the "Z" value in part number: use "BP" to order with backing media or "NP" for no backing media
Silicone backing paper is yellow, acrylic backing paper is blue. Same price with or without backing.
- All tapes are 36 yards. 18 yard rolls are available at -30% of the price shown.
- Adhesive thickness of Acrylic is .002". Silicone adhesive is .0022" thick for .003 & .005 tape and .0030" thick for all others.

The PTFE resin is applied to the base fabric in a hot process and under pressure, causing a total impregnation of the base fabric. The surface of the resin is smooth and it takes considerable and aggressive force to scratch the PTFE surface to remove it from the fabric with fingernail scraping.

Fiberglass Tape with PTFE Resin Impregnation & Self Adhesive 500°F / 260°C: Tuff-Flex™ High Temperature & Chemical Resistant with Smooth Non-Stick Surface - Industrial Grade



- This tape is made by slitting our PTFE resin impregnated fiberglass fabric. Available with and without backing media on the adhesive side. Available with Acrylic or Silicone adhesive.
- Provides excellent chemical resistance and superior electrical insulation. Used as a low friction release tape for heat sealing and other packaging applications.
- Used on various machinery parts to provide a smooth stick-free surface such as on production line runners and guides for easy product and parts conveyance.
- Used as an electrical tape for high insulation and high temperature performance.
- Industrial Grade is a smooth surface with slight surface texturization (underlying fiberglass weave). Premium Grade is an exceptionally smooth surface with a higher PTFE content than Industrial Grade.
- Temperature range: Silicone adhesive tape -100°F to +500°F (-73°C to +260°C). Acrylic adhesive tapes -40°F to +350°F (-40°C to +177°C).

Tuff-Flex™ High Temperature, Heat & Chemical Resistant Fiberglass Tape with PTFE Resin Impregnation & Self Adhesive: Industrial Grade

Part Number	Width in / mm		Price per Roll by Thickness Silicone or Acrylic Adhesive (thickness measurement does not include adhesive)				
			X = 3 .003"	X = 5 .005"	X = 6 .006"	X = 10 .010"	X = 14 .014" *
			Dielectric S = 5 kV / A = 5 kV	Dielectric S = 6 kV / A = 6 kV	Dielectric S = 8 kV / A = 8 kV	Dielectric S = 9.5 kV / A = 8.5 kV	Dielectric S = 10.5 kV / A = 9 kV
T-FG-PTRI-I-M013-08-X-Y-Z	.5	13	\$ 23.55 *	\$ 33.09 *	\$ 37.56 *	\$ 44.19 *	\$ 67.80 *
T-FG-PTRI-I-M019-12-X-Y-Z	.75	19	\$ 35.33 *	\$ 49.64 *	\$ 56.34 *	\$ 66.29 *	\$ 101.70
T-FG-PTRI-I-M025-16-X-Y-Z	1.0	25	\$ 47.10 *	\$ 66.18 *	\$ 75.12 *	\$ 88.38	\$ 135.60
T-FG-PTRI-I-M032-20-X-Y-Z	1.25	32	\$ 58.88	\$ 82.73	\$ 93.90	\$ 110.48	\$ 169.50
T-FG-PTRI-I-M038-24-X-Y-Z	1.5	38	\$ 70.65	\$ 99.27	\$ 112.68	\$ 132.57	\$ 203.40
T-FG-PTRI-I-M051-32-X-Y-Z	2.0	51	\$ 94.20	\$ 132.36	\$ 150.24	\$ 176.76	\$ 271.20
T-FG-PTRI-I-M064-40-X-Y-Z	2.5	64	\$ 117.75	\$ 165.45	\$ 187.80	\$ 220.95	\$ 339.00
T-FG-PTRI-I-M076-48-X-Y-Z	3.0	76	\$ 141.30	\$ 198.54	\$ 225.36	\$ 265.14	\$ 406.80
Other Widths			\$ 47.10 / in	\$ 66.18 / in	\$ 75.12 / in	\$ 88.38 / in	\$ 135.60 / in
Tensile Strength Warp / Fill (lbs/in)	Silicone		100 / 50	135 / 120	150 / 140	250 / 155	440 / 250
	Acrylic		90 / 50	135 / 120	150 / 140	250 / 155	440 / 250
Tear Strength Warp / Fill (lbs)	Silicone		1.7 / 0.9	2.3 / 1.5	2.0 / 1.5	4.9 / 3.0	7.0 / 5.0
	Acrylic		1.7 / 0.9	1.8 / 1.5	2.0 / 1.5	6.0 / 3.0	7.0 / 5.0

***Note: Minimum order for indicated tapes is 2 rolls** Custom slitting available up to a maximum of 36 inches.

- For the "X" value in the part number, use "3" for .003, "5" for .005, "6" for .006, "10" for .010, "14" for .014
- For the "Y" value specify "A" or "S" in the part number to correspond to the desired adhesive
A = Acrylic S = Silicone
- For the "Z" value in part number: use "BP" to order with backing media or "NP" for no backing media
Silicone backing paper is yellow, acrylic backing paper is blue. Same price with or without backing.
- All tapes are 36 yards. 18 yard rolls are available at -30% of the price shown.
- Adhesive thickness of Acrylic is .002". Silicone adhesive is .0022" thick for .003 & .005 tape and .0030" thick for all others.

The PTFE resin is applied to the fabric in a hot process and under pressure, causing a total impregnation of the base fabric. The surface of the resin is smooth and it takes considerable and aggressive force to scratch the ptfе surface to remove it from the fabric with fingernail scraping.

Skived PTFE Tape with Self Adhesive

590°F / 310°C: Tuff-Flex™ High Temperature & Chemical Resistance with Ultra Smooth Non-Stick Surface



- High elongation provides excellent conformability around splices and connectors.
- Available with and without backing strip.
- Available with Acrylic or Silicone adhesive
- Providing excellent chemical resistance and superior electrical insulation. Used as a low friction release tape for heat sealing and other packaging applications.
- Used on various machinery parts to provide a smooth stick-free surface such as on production line runners, rollers and guides for easy product and parts conveyance.
- Used as an electrical tape for high insulation and high temperature performance. 2540v/mil dielectric breakdown (minimum).
- Used for splicing of PTFE coated wiring and for forming watertight seals around blasting cap and detonating cord, lap splicing of firing cable (mining & underwater demolition).

Tuff-Flex™ High Temperature, Heat & Chemical Resistance Skived PTFE Tape with Self Adhesive					
Part Number	Width in / mm		Price per Roll by Thickness (thickness measurement does not include adhesive)		
			X = 3 .003"	X = 5 .005"	X = 10 .010"
T-PT-SK-M013-08-X-Y-Z	.5	13	\$ 25.25	\$ 30.53	\$ 46.38
T-PT-SK-M019-12-X-Y-Z	.75	19	\$ 37.87	\$ 45.79	\$ 69.57
T-PT-SK-M025-16-X-Y-Z	1.0	25	\$ 50.49	\$ 61.05	\$ 92.76
T-PT-SK-M032-20-X-Y-Z	1.25	32	\$ 63.11	\$ 76.31	\$ 115.95
T-PT-SK-M038-24-X-Y-Z	1.5	38	\$ 75.74	\$ 91.56	\$ 139.14
T-PT-SK-M051-32-X-Y-Z	2.0	51	\$ 100.98	\$ 122.10	\$ 185.52
T-PT-SK-M064-40-X-Y-Z	2.5	64	\$ 126.22	\$ 152.63	\$ 231.90
T-PT-SK-M076-48-X-Y-Z	3.0	76	\$ 151.47	\$ 183.15	\$ 278.28
Other Widths			\$ 50.49 / inch	\$ 61.05 / inch	\$ 92.76 / inch
T-PT-SK-MXXX-XX-T1C2			MIL-I-23594C / MIL-I-59474 / A-A-59474: Type I Class 2 - \$65.23 / inch		
T-PT-SK-MXXX-XX-T1C4			MIL-I-23594C / MIL-I-59474 / A-A-59474: Type I Class 4 - \$77.34 / inch		

Price is for tape with Silicone adhesive. For Acrylic adhesive subtract 5% from price shown

Custom slitting to any width is available up to a maximum of 36 inches. Sold in full rolls only.

- **For the "X" value**, specify "3" for .003" thickness, "5" for .005" thickness, "10" for .010" thickness
- **For the "Y" value**, specify "A" or "S" in the part number to correspond to the desired adhesive
A = Acrylic S = Silicone
- **For the "Z" value**, use "BP" for with Backing Paper or "NP" for no backing paper
Silicone backing paper is yellow, acrylic backing paper is blue. Same price with or without backing.
- Add "T1C2" or "T1C4" as a suffix to the part number for tape meeting MIL-I-23594C / A-A-59474.
- All tapes are 36 yards. 18 yard rolls are available at 70% of the price shown.
- Adhesive thickness of Acrylic is .002". Silicone adhesive is .0022" thick.

MIL-I-23594C / A-A-59474 Skived PTFE Tape with Self Adhesive
590°F / 310°C: Tuff-Flex™ High Temperature & Chemical Resistance with Ultra Smooth Non-Stick Surface



- High elongation provides excellent conformability around splices and connectors.
- Available with and without backing strip.
- Available with Acrylic or Silicone adhesive
- Providing excellent chemical resistance and superior electrical insulation. Used as a low friction release tape for heat sealing and other packaging applications.
- Used on various machinery parts to provide a smooth stick-free surface such as on production line runners, rollers and guides for easy product and parts conveyance.
- Used as an electrical tape for high insulation and high temperature performance. 2540v/mil dielectric breakdown (minimum).
- Used for splicing of PTFE coated wiring and for forming watertight seals around blasting cap and detonating cord, lap splicing of firing cable (mining & underwater demolition).

MIL-I-23594C / A-A-59474 Skived PTFE Tape with Self Adhesive
Tuff-Flex™ High Temperature, Heat & Chemical Resistance

Part Number	Width in / mm		Price per Roll by Thickness (thickness measurement does not include adhesive)	
			X = 3 .003" T1C2	X = 5 .005" T1C4
T-AA59474-23594-0.500-X-Z	.5	13	\$ 32.62	\$ 38.67
T-AA59474-23594-0.750-X-Z	.75	19	\$ 49.67	\$ 58.00
T-AA59474-23594-1.000-X-Z	1.0	25	\$ 65.23	\$ 77.34
T-AA59474-23594-1.250-X-Z	1.25	32	\$ 81.54	\$ 96.68
T-AA59474-23594-1.500-X-Z	1.5	38	\$ 97.85	\$ 116.01
T-AA59474-23594-2.000-X-Z	2.0	51	\$ 130.46	\$ 154.68
T-AA59474-23594-2.500-X-Z	2.5	64	\$ 163.07	\$ 193.35
T-AA59474-23594-3.000-X-Z	3.0	76	\$ 195.69	\$ 232.02
Other Widths			\$ 65.23 / inch	\$ 77.34 / inch

Price is for tape with Silicone adhesive.

Custom slitting to any width is available up to a maximum of 36 inches. Sold in full rolls only.

- **For the "X" value**, specify "3" for .003" thickness, "5" for .005" thickness, "10" for .010" thickness
- **For the "Z" value**, use "BP" for with Backing Paper or "NP" for no backing paper
Silicone backing paper is yellow, acrylic backing paper is blue. Same price with or without backing.
- All tapes are 36 yards. 18 yard rolls are available at 70% of the price shown.
- Adhesive thickness of Acrylic is .002". Silicone adhesive is .0022" thick.

Tuff-Flex™ Expanded PTFE Joint Seal Tape

550°F / 287°C: High Temperature & Chemical Resistance



- Made from ePTFE

Pure ePTFE joint seal tape with an adhesive backing makes a superb cord formed gasket for use as a jointing on all types of flanges. Excellent corrosion resistance, high pressure resistance, easy to use, soft and is ideal for enamel, glass, and especially rough and special shaped sealing.

Excellent resistance to almost all solvents, caustics and acids.

PTFE melting point is 620°F / 327°C.

- PH Range: 0 to 14
- Maximum tensile: 4260 psi (30Mpa)

- Temperature Range: -500F / -268C to +500F / +260C
- Pressure Limits: 2900 psi / 200 kgf/cm² (20Mpa)

550°F / 287°C continuous rating

This is a high-performance ePTFE used in almost all industries for its heat protection & Chemical Resistance.

Tuff-Flex™ High Temperature, Heat & Chemical Resistance ePTFE Joint Seal					
Part Number	Dimension Width (inch) / Length (feet) / Thickness (inch)	Price per spool	Part Number	Dimension Width (inch) / Length (feet) / Thickness (inch)	Price per spool
T-PT-JS-125-100	.125" / 100' / 0.10"	\$ 103.47	T-PT-JS-500-15	.500" / 15' / 0.21"	\$ 84.70
T-PT-JS-125-500	.125" / 500' / 0.10"	\$ 387.50	T-PT-JS-500-30	.500" / 30' / 0.21"	\$ 129.43
T-PT-JS-187-75	.187" / 75' / 0.10"	\$ 104.47	T-PT-JS-500-150	.500" / 150' / 0.21"	\$ 576.33
T-PT-JS-187-500	.187" / 500' / 0.10"	\$ 507.33	T-PT-JS-625-15	.625" / 15' / 0.23"	\$ 96.30
T-PT-JS-250-50	.250" / 50' / 0.10"	\$ 100.47	T-PT-JS-625-30	.625" / 30' / 0.23"	\$ 192.43
T-PT-JS-250-100	.250" / 100' / 0.10"	\$ 197.90	T-PT-JS-625-150	.625" / 150' / 0.23"	\$ 873.25
T-PT-JS-250-250	.250" / 250' / 0.10"	\$ 376.50	T-PT-JS-750-15	.750" / 15' / 0.25"	\$ 147.67
T-PT-JS-250-500	.250" / 500' / 0.10"	\$ 749.00	T-PT-JS-750-30	.750" / 30' / 0.25"	\$ 295.20
T-PT-JS-375-25	.375" / 25' / 0.17"	\$ 79.70	T-PT-JS-750-100	.750" / 100' / 0.25"	\$ 939.20
T-PT-JS-375-50	.375" / 50' / 0.17"	\$ 149.43	T-PT-JS-1000-15	1.000" / 15' / 0.30"	\$ 221.35
T-PT-JS-375-250	.375" / 250' / 0.17"	\$ 576.33	T-PT-JS-1000-30	1.000" / 30' / 0.30"	\$ 442.73
			T-PT-JS-1000-75	1.000" / 75' / 0.30"	\$ 1056.58

* Note: The PSA will burn off at temperatures above 400°F and should be used to facilitate installation. Material with PSA should not be used in confined areas at elevated temperatures without ventilation until all of the PSA has vaporized.

NOTE: This product is made in round form, then flattened: the width and thickness tolerance is +/- 0.063" for 0.50" wide seal and larger, and +/- 0.031" for 0.375" wide seal and smaller.

This Product is NOT Available By The Foot

Fiberglass Tape with PTFE Resin Impregnation, Non-Adhesive / FDA 500°F / 260°C: Tuff-Flex™ High Temperature & Chemical Resistant with Smooth Non-Stick Surface - Premium Grade



- This tape is made by slitting our PTFE resin impregnated fiberglass fabric. Available with and without backing media on the adhesive side. Available with Acrylic or Silicone adhesive.
- Provides excellent chemical resistance and superior electrical insulation. Used as a low friction release tape for heat sealing bars and other packaging applications.
- Used on various machinery parts to provide a smooth stick-free surface such as on production line runners and guides for easy product and parts conveyance.
- Used as an electrical tape for high insulation and high temperature performance.
- Premium Grade is an exceptionally smooth surface with a higher PTFE content than Industrial Grade.
- Temperature range: Silicone adhesive tape -100°F to +500°F (-73°C to +260°C). Acrylic adhesive tapes -40°F to +350°F (-40°C to +177°C).

Tuff-Flex™ High Temperature, Heat & Chemical Resistant Fiberglass Tape with PTFE Resin Impregnation & Self Adhesive: Premium Grade

Part Number	Width in / mm		Price per Roll by Thickness Silicone or Acrylic Adhesive (thickness measurement does not include adhesive)			
			X = 3 .003" Dielectric S = 5 kV / A = 4.5 kV	X = 5 .005" Dielectric S = 7.5 kV / A = 7 kV	X = 6 .006" Dielectric S = 8.5 kV / A = 8.5 kV	X = 10 .010" Dielectric S = 9.5 kV / A = 9 kV
T-FG-PTRI-P-M013-08-X-Y-Z	.5	13	\$ 28.26 *	\$ 39.71 *	\$ 45.07 *	\$ 53.03 *
T-FG-PTRI-P-M019-12-X-Y-Z	.75	19	\$ 42.40 *	\$ 59.57 *	\$ 67.61 *	\$ 79.55 *
T-FG-PTRI-P-M025-16-X-Y-Z	1.0	25	\$ 56.52 *	\$ 79.42 *	\$ 90.14	\$ 106.06
T-FG-PTRI-P-M032-20-X-Y-Z	1.25	32	\$ 70.66	\$ 99.28	\$ 112.68	\$ 132.58
T-FG-PTRI-P-M038-24-X-Y-Z	1.5	38	\$ 84.78	\$ 119.12	\$ 135.22	\$ 159.08
T-FG-PTRI-P-M051-32-X-Y-Z	2.0	51	\$ 113.04	\$ 158.83	\$ 180.29	\$ 212.11
T-FG-PTRI-P-M064-40-X-Y-Z	2.5	64	\$ 141.30	\$ 198.54	\$ 225.36	\$ 265.14
T-FG-PTRI-P-M076-48-X-Y-Z	3.0	76	\$ 169.56	\$ 238.25	\$ 270.43	\$ 318.17
Other Widths			\$ 56.52 / in	\$ 79.42 / in	\$ 90.14 / in	\$ 106.06 / in
Tensile Strength Warp / Fill (lbs/in)	Silicone		95 / 55	140 / 130	150 / 115	325 / 235
	Acrylic		95 / 55	125 / 130	150 / 150	325 / 235
Tear Strength Warp / Fill (lbs)	Silicone		1.5 / 0.9	2.2 / 1.7	2.1 / 1.8	7.5 / 4.0
	Acrylic		1.5 / 0.9	1.8 / 1.7	2.1 / 1.7	7.5 / 4.0

* NOTE: Minimum order for indicated tapes is 2 rolls Custom slitting available up to a maximum of 36 inches.

- For the "X" value in the part number, use "3" for .003, "5" for .005, "6" for .006, "10" for .010, "14" for .014
- For the "Y" value specify "A" or "S" in the part number to correspond to the desired adhesive
A = Acrylic S = Silicone
- For the "Z" value in part number: use "BP" to order with backing media or "NP" for no backing media
Silicone backing paper is yellow, acrylic backing paper is blue. Same price with or without backing.
- All tapes are 36 yards. 18 yard rolls are available at -30% of the price shown.
- Adhesive thickness of Acrylic is .002". Silicone adhesive is .0022" thick for .003 & .005 tape and .0030" thick for all others.

The PTFE resin is applied to the base fabric in a hot process and under pressure, causing a total impregnation of the base fabric. The surface of the resin is smooth and it takes considerable and aggressive force to scratch the PTFE surface to remove it from the fabric with fingernail scraping.

Fiberglass Tape with PTFE Resin Impregnation, Non Adhesive / FDA 500°F / 260°C: Tuff-Flex™ High Temperature & Chemical Resistant with Smooth Non-Stick Surface - Industrial Grade



- This tape is made by slitting our PTFE resin impregnated fiberglass fabric. Available with and without backing media on the adhesive side. Available with Acrylic or Silicone adhesive.
- Provides excellent chemical resistance and superior electrical insulation. Used as a low friction release tape for heat sealing and other packaging applications.
- Used on various machinery parts to provide a smooth stick-free surface such as on production line runners and guides for easy product and parts conveyance.
- Used as an electrical tape for high insulation and high temperature performance.
- Industrial Grade is a smooth surface with slight surface texturization (underlying fiberglass weave). Premium Grade is an exceptionally smooth surface with a higher PTFE content than Industrial Grade.
- Temperature range: Silicone adhesive tape -100°F to +500°F (-73°C to +260°C). Acrylic adhesive tapes -40°F to +350°F (-40°C to +177°C).

Tuff-Flex™ High Temperature, Heat & Chemical Resistant Fiberglass Tape with PTFE Resin Impregnation & Self Adhesive: Industrial Grade

Part Number	Width in / mm		Price per Roll by Thickness Silicone or Acrylic Adhesive (thickness measurement does not include adhesive)				
			X = 3 .003"	X = 5 .005"	X = 6 .006"	X = 10 .010"	X = 14 .014" *
			Dielectric S = 5 kV / A = 5 kV	Dielectric S = 6 kV / A = 6 kV	Dielectric S = 8 kV / A = 8 kV	Dielectric S = 9.5 kV / A = 8.5 kV	Dielectric S = 10.5 kV / A = 9 kV
T-FG-PTRI-I-M013-08-X-Y-Z	.5	13	\$ 23.55 *	\$ 33.09 *	\$ 37.56 *	\$ 44.19 *	\$ 67.80 *
T-FG-PTRI-I-M019-12-X-Y-Z	.75	19	\$ 35.33 *	\$ 49.64 *	\$ 56.34 *	\$ 66.29 *	\$ 101.70
T-FG-PTRI-I-M025-16-X-Y-Z	1.0	25	\$ 47.10 *	\$ 66.18 *	\$ 75.12 *	\$ 88.38	\$ 135.60
T-FG-PTRI-I-M032-20-X-Y-Z	1.25	32	\$ 58.88	\$ 82.73	\$ 93.90	\$ 110.48	\$ 169.50
T-FG-PTRI-I-M038-24-X-Y-Z	1.5	38	\$ 70.65	\$ 99.27	\$ 112.68	\$ 132.57	\$ 203.40
T-FG-PTRI-I-M051-32-X-Y-Z	2.0	51	\$ 94.20	\$ 132.36	\$ 150.24	\$ 176.76	\$ 271.20
T-FG-PTRI-I-M064-40-X-Y-Z	2.5	64	\$ 117.75	\$ 165.45	\$ 187.80	\$ 220.95	\$ 339.00
T-FG-PTRI-I-M076-48-X-Y-Z	3.0	76	\$ 141.30	\$ 198.54	\$ 225.36	\$ 265.14	\$ 406.80
Other Widths			\$ 47.10 / in	\$ 66.18 / in	\$ 75.12 / in	\$ 88.38 / in	\$ 135.60 / in
Tensile Strength Warp / Fill (lbs/in)	Silicone		100 / 50	135 / 120	150 / 140	250 / 155	440 / 250
	Acrylic		90 / 50	135 / 120	150 / 140	250 / 155	440 / 250
Tear Strength Warp / Fill (lbs)	Silicone		1.7 / 0.9	2.3 / 1.5	2.0 / 1.5	4.9 / 3.0	7.0 / 5.0
	Acrylic		1.7 / 0.9	1.8 / 1.5	2.0 / 1.5	6.0 / 3.0	7.0 / 5.0

***Note: Minimum order for indicated tapes is 2 rolls** Custom slitting available up to a maximum of 36 inches.

- For the "X" value in the part number, use "3" for .003, "5" for .005, "6" for .006, "10" for .010, "14" for .014
- For the "Y" value specify "A" or "S" in the part number to correspond to the desired adhesive
A = Acrylic S = Silicone
- For the "Z" value in part number: use "BP" to order with backing media or "NP" for no backing media
Silicone backing paper is yellow, acrylic backing paper is blue. Same price with or without backing.
- All tapes are 36 yards. 18 yard rolls are available at -30% of the price shown.
- Adhesive thickness of Acrylic is .002". Silicone adhesive is .0022" thick for .003 & .005 tape and .0030" thick for all others.

The PTFE resin is applied to the fabric in a hot process and under pressure, causing a total impregnation of the base fabric. The surface of the resin is smooth and it takes considerable and aggressive force to scratch the ptfе surface to remove it from the fabric with fingernail scraping.

Tacky-Cloth™ White Rubber Coated Fiberglass Gasket Tape
550°F / 287°C: Tuff-Flex™ High Temperature Heat Resistant Tape: *With or Without Wire Insert*



This is a widely used and universal tape for making gaskets, especially where a rough or uneven surface or flange exists. The tape is a fiberglass base with a special white rubber formulation. The tape is tacky, and has a plastic film surface covering that is removed before installation. The tape will stick to itself once the film is removed.

Wire Inserted Version: The fill (width wise) yarn for this version of the fabric has a twisted brass wired formed with it, providing additional dimensional stability/strength.

550°F / 287°C continuous rating, excellent sealing properties as a gasket material

Tuff-Flex™ High Temperature White Rubber Coated Fiberglass Universal Gasket Tape (Tacky Cloth)						
Part Number	Width in / mm	Price per Foot By Thickness: A / B / C / D / E				
		“A” thickness .062 / 1.6	“B” thickness .125 / 3.2	“C” thickness .187 / 4.8	“D” thickness .250 / 6.3	“E” thickness .375 / 7.9
T-FG-TC-M013-08-X-Z	.50 / 13	NA	\$ 1.40	\$ 2.08	\$ 2.76	NA
T-FG-TC-M019-12-X-Z	.75 / 19	NA	\$ 1.84	\$ 2.48	\$ 3.44	NA
T-FG-TC-M025-16-X-Z	1.0 / 25	\$ 1.12	\$ 2.20	\$ 3.20	\$ 4.32	\$ 6.88
T-FG-TC-M032-20-X-Z	1.25 / 32	\$ 1.40	\$ 2.72	\$ 4.04	\$ 5.40	\$ 8.32
T-FG-TC-M038-24-X-Z	1.50 / 38	\$ 1.60	\$ 3.20	\$ 4.84	\$ 6.52	\$ 9.96
T-FG-TC-M051-32-X-Z	2.00 / 51	\$ 2.20	\$ 4.32	\$ 6.52	\$ 8.60	\$ 12.96
T-FG-TC-M076-48-X-Z	3.00 / 76	\$ 3.04	\$ 6.08	\$ 9.24	\$ 12.28	\$ 19.44
T-FG-TC-M102-64-X-Z	4.00 / 102	\$ 4.08	\$ 8.20	\$ 12.28	\$ 16.40	\$ 25.88
T-FG-TC-M127-80-X-Z	5.00 / 127	\$ 4.92	\$ 10.20	\$ 15.32	\$ 20.40	\$ 32.44

For the “X” value specify either A, B, C, D, or E
For the “Z” value, use “W” to specify with wire insert and “N” to specify no wire

Gasket Cloth with and without Wire Insert – Same Price with Either Option

Standard Rolls of 25 and 50 feet. Other lengths add +25% to price.

Curing: It is recommended that this material be cured in situ. This material must be heated to a minimum of 300°F within 60 minutes, then it must sit at 300°F or higher for 90 minutes for the rubber to fully cure.

Do not overtorque the material during this curing time or the rubber will be squeezed off of the base material.

If the material is not fully cured, the rubber will drip from the material causing voids. After curing the material can be exposed to a lower operational temperature.

Tacky Cloth™ Luting & Groove Packing 550°F / 287°C: Tuff-Flex™ High Temperature Heat Resistant, Wire Inserted



- Luting & groove packing.
- Formed square: available rectangular or round.
- Standard 25 and 50 foot lengths.
- Add +25% to the price for non standard lengths.

550°F / 287°C continuous rating, excellent sealing properties as a gasket material

Tuff-Flex™ High Temperature Luting & Groove Packing - Square			
Part Number	Size in / mm	Price per Foot	
		Regular	Graphite Coated
T-FG-TC-LGP-M010-06-X	.375 / 10	\$ 5.70	\$ 11.20
T-FG-TC-LGP-M013-08-X	.500 / 13	\$ 6.43	\$ 11.93
T-FG-TC-LGP-M016-10-X	.625 / 16	\$ 9.37	\$ 14.87
T-FG-TC-LGP-M019-12-X	.750 / 19	\$ 9.90	\$ 15.40
T-FG-TC-LGP-M022-14-X	.875 / 22	\$ 12.47	\$ 17.97
T-FG-TC-LGP-M025-16-X	1.00 / 25	\$ 17.50	\$ 22.97
T-FG-TC-LGP-M029-18-X	1.125 / 29	\$ 19.57	\$ 23.40
T-FG-TC-LGP-M032-20-X	1.250 / 32	\$ 31.93	\$ 37.43
T-FG-TC-LGP-M038-24-X	1.500 / 38	\$ 32.67	\$ 38.16

For the “X” value specify either “R” for Regular, or “GC” for Graphite Coated

Standard Rolls of 25 and 50 feet. Other lengths add +25% to price.

Curing: It is recommended that this material be cured in situ. This material must be heated to a minimum of 300°F within 60 minutes, then it must sit at 300°F or higher for 90 minutes for the rubber to fully cure.

Do not overtorque the material during this curing time or the rubber will be squeezed off of the base material.

If the material is not fully cured, the rubber will drip from the material causing voids. After curing the material can be exposed to a lower operational temperature.

Woven Fiberglass Electrical Apparatus Insulating Tape: Premium Grade 1200°F / 648°C: DeltaGlass™ Very High Temperature & Heat Resistant

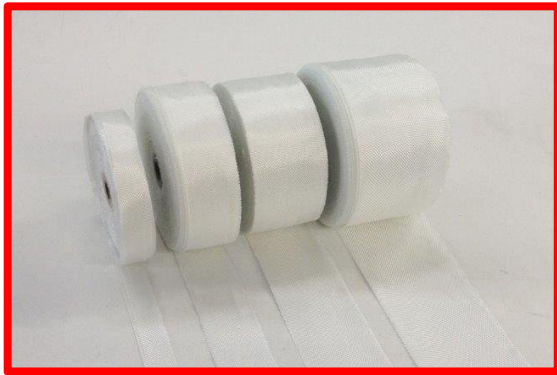

- Woven from filament fiberglass yarns, this tape will withstand temperatures up to 1200°F / 648°C in continuous service.
- Used extensively as an insulating tape in transformers, motors and generators. This tape is a bright white color. Selvaged edge to prevent fraying.
- This tape offers superior insulating properties as well as very low chloride and alkali content.
- Other widths available by custom order.
- Various finishes and treatments available including heat cleaned.

1200°F / 648°C continuous rating, high insulation value

Fiberglass Woven Tape for Electrical Apparatus Construction High Temperature & Heat Resistant									
Part Number	Width in / mm		Base Price per Roll; By Thickness						
			"A" thickness .003" / .08mm Base Price	"B" thickness .004" / .10mm Base Price	"C" thickness .005" / .13mm Base Price	"D" thickness .007" / .18mm Base Price	"E" thickness .010" / .25mm Base Price	"F" thickness .015" / .38mm Base Price	"G" thickness .020" / .51mm Base Price
Medium Weave - Type A									
T-FG-WOVEN-A-M013-08-X	.5	13	N/A	\$ 5.00	\$ 5.00	\$ 5.00	\$ 5.00	N/A	N/A
Warp Total Ends / Fill Picks/in				W 26 / F 26	W 25 / F 26	W 25 / F 26	W 42 / F 18		
T-FG-WOVEN-A-M019-12-X	.75	19	N/A	\$ 5.00	\$ 5.00	\$ 5.00	\$ 5.00	\$ 5.00	N/A
Warp Total Ends / Fill Picks/in				W 37 / F 26	W 37 / F 26	W 37 / F 26	W 66 / F 18	W 19 / F 16	
T-FG-WOVEN-A-M025-16-X	1.0	25	N/A	\$ 5.00	\$ 5.00	\$ 5.00	\$ 5.00	\$ 5.00	\$ 5.00
Warp Total Ends / Fill Picks/in				W 49 / F 26	W 49 / F 26	W 49 / F 26	W 86 / F 18	W 26 / F 16	W 45 / F 15
T-FG-WOVEN-A-M038-24-X	1.5	38	N/A	\$ 5.00	\$ 5.00	\$ 5.00	\$ 5.00	N/A	\$ 5.00
Warp Total Ends / Fill Picks/in				W 73 / F 26	W 71 / F 26	W 71 / F 26	W 132 / F 18		W 68 / F 15
Tight Weave - Type B									
T-FG-WOVEN-B-M013-08-X	.5	13	N/A	\$ 5.00	\$ 5.00	\$ 5.00	\$ 5.00	N/A	N/A
Warp Total Ends / Fill Picks/in				W 26 / F 30	W 25 / F 33	W 25 / F 33	W 42 / F 22		
T-FG-WOVEN-B-M019-12-X	.75	19	N/A	\$ 5.00	\$ 5.00	\$ 5.00	\$ 5.00	N/A	N/A
Warp Total Ends / Fill Picks/in				W 37 / F 30	W 37 / F 33	W 37 / F 33	W 66 / F 22		
T-FG-WOVEN-B-M025-16-X	1.0	25	N/A	\$ 5.00	\$ 5.00	\$ 5.00	\$ 5.00	N/A	N/A
Warp Total Ends / Fill Picks/in				W 49 / F 30	W 49 / F 33	W 49 / F 33	W 86 / F 22		
T-FG-WOVEN-B-M038-24-X	1.5	38	N/A	\$ 5.00	\$ 5.00	\$ 5.00	N/A	N/A	N/A
Warp Total Ends / Fill Picks/in				W 73 / F 30	W 71 / F 33	W 71 / F 33			
Mil Spec Weave MIL-Y-1140 - Type M									
T-FG-WOVEN-M-M013-08-X	.5	13	\$ 5.00	N/A	\$ 5.00	\$ 5.00	N/A	N/A	N/A
Warp Total Ends / Fill Picks/in			W 29 / F 42		W 26 / F 38	W 26 / F 38			
T-FG-WOVEN-M-M019-12-X	.75	19	\$ 5.00	N/A	\$ 5.00	\$ 5.00	N/A	N/A	N/A
Warp Total Ends / Fill Picks/in			W 45 / F 42		W 38 / F 38	W 38 / F 38			
T-FG-WOVEN-M-M025-16-X	1.0	25	\$ 5.00	N/A	\$ 5.00	\$ 5.00	N/A	N/A	N/A
Warp Total Ends / Fill Picks/in			W 62 / F 42		W 51 / F 38	W 51 / F 38			

- For the "X" Value in the part number, specify A, B, C, D, E, F or G to correspond to the desired thickness.

Price shown is the base price for the tape. For CT Finish multiply price by 1.25. For CT Yellow finish multiply price by 1.35. For G10E Finish multiply price by 1.40. For Gilt edge finish multiply price by 1.20. For 112 finish multiply price by 1.37. For #16 finish multiply price by 1.30. For Golden Gilt Edge finish multiply price by 1.45.



Fiberglass Knitted Gasket / Thermal Insulation Tape
1200°F / 648°C: DeltaGlass™ Very High Temperature & Heat Resistant
Plain Tape & Bolt Hole / Drop-Warp / LadderTape™: Premium Grade



These knitted tapes are fabricated from high quality type E fiberglass that will not burn and will withstand continuous exposure to temperatures of 1200°F / 648°C.

This material resists most acids and alkalis and is unaffected by most bleaches and solvents. It is highly flexible and conformable.

The base fiber is manufactured to the specifications of ASTM D-578, ASTM committee D13, and subcommittee D13.18.

Knitted tapes are extremely flexible and highly conformable, much more so than the same dimension tape in a woven style.

Texturized yarn ensures high bulk and high thermal insulation value.

A Heat Treated version of this product is available – please enquire.

1200°F / 648°C continuous rating, high insulation value & excellent personnel protection

Very High Temperature & Heat Resistant Fiberglass Knitted Tape: Plain & Bolt Hole/Drop-Warp/LadderTape™ - Premium			
1/8" / 3mm Thick Knitted Plain Tape / Drop-Warp - LadderTape™			
Part Number	Width inch / mm		Price per Roll Plain / Drop Warp
T-FG-KNIT-1.000-M025-X	1"	25	\$ 71.67 / \$ 61.67
T-FG-KNIT-1.250-M032-X	1 1/4"	32	\$ 90.00 / \$ 78.33
T-FG-KNIT-1.500-M038-X	1 1/2"	38	\$ 110.00 / \$ 90.00
T-FG-KNIT-1.750-M044-X	1 3/4"	44	\$ 135.00 / \$ 100.00
T-FG-KNIT-2.000-M051-X	2"	51	\$ 156.67 / \$ 110.00
T-FG-KNIT-2.500-M064-X	2 1/2"	64	\$ 180.00 / \$ 133.33
T-FG-KNIT-3.000-M076-X	3"	76	\$ 210.00 / \$ 163.33
T-FG-KNIT-4.000-M102-X	4"	102	\$ 256.67 / \$ 210.00
T-FG-KNIT-5.000-M127-X	5"	127	\$ 306.67 / \$ 260.00

Each roll contains 100 feet / 30 metres.

For the "X" value specify either "P" for Plain Style, or "DW" for Drop Warp (Bolt-Hole / Ladder)

This Product is NOT Available By-The-Foot – Full Rolls Only

To aid in mounting this tape onto surfaces, FlangeStik™ pressure sensitive adhesive spray can be used to place the tape in situ temporarily. Permanent fasteners or grab strips should be installed prior to heating of the area sprayed above 200°F. The adhesive will "smoke-off" at elevated temperatures.

**Woven Fiberglass Gasket / Thermal Insulating Tape: Premium Grade
1200°F / 648°C: DeltaGlass™ Very High Temperature & Heat Resistant Plain &
Drop-Warp (Bolt-Hole / Ladder Tape™)**

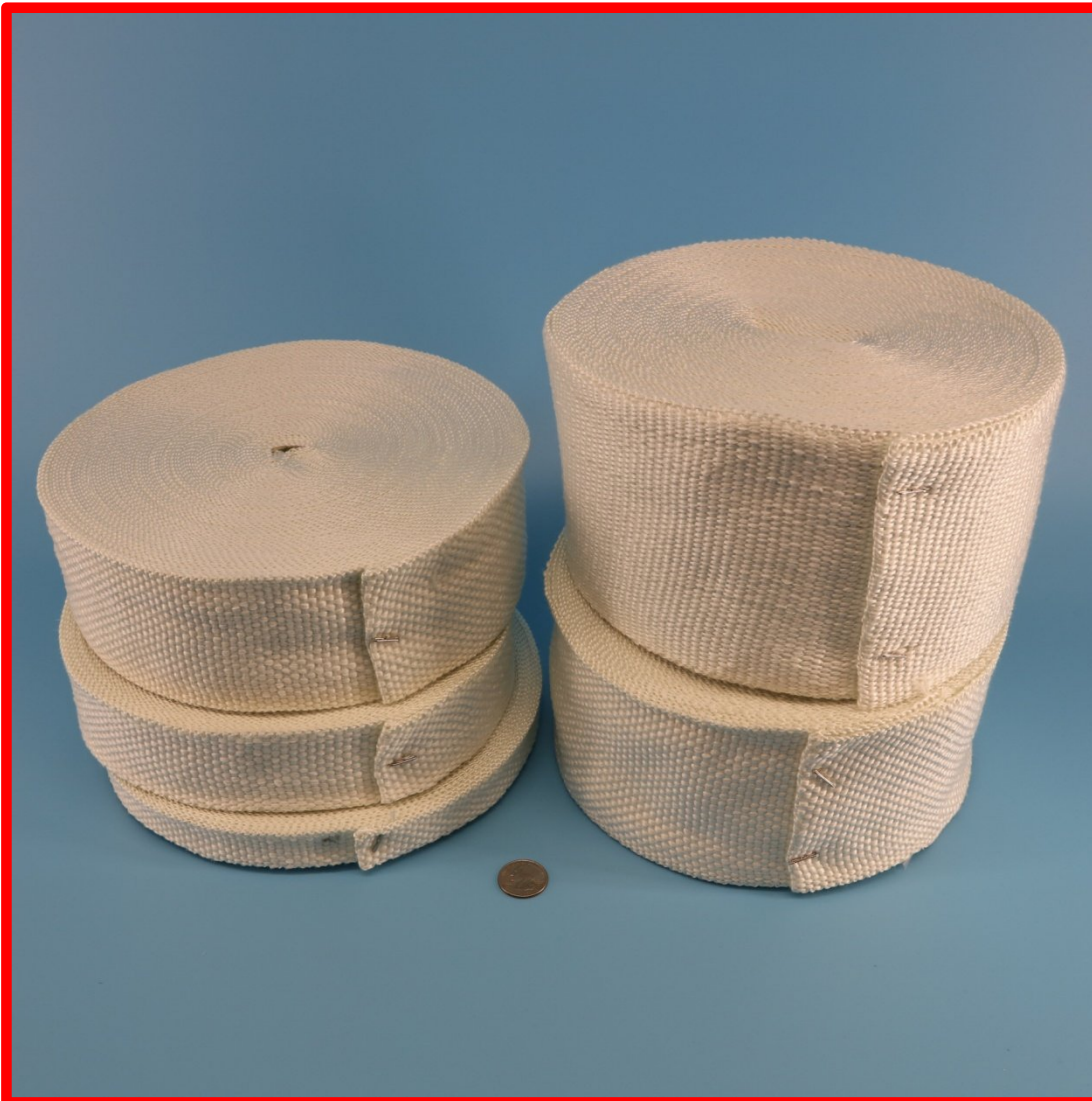

Manufactured of texturized fiberglass yarns, this tape will withstand temperatures up to 1200°F / 648°C in continuous service. 100% asbestos free, this tape is a bright white color.

This tape offers superior insulating properties as well as low chloride content.

Offered in *Plain* and *Drop Warp (also known as Bolt-Hole or LadderTape™)*. Drop Warp tape has lengthwise yarns missing from the center of the tape to allow fasteners to pass through the tape for assembly onto access doors, etc.

A Heat Treated version of this product is available – please enquire. Also available with Pressure Sensitive Adhesive (PSA) (see following page).

1200°F / 648°C continuous rating, high insulation value & excellent personnel protection

Woven Fiberglass Gasket / Thermal Insulating Tape: Premium Grade
 (Continued)



Very High Temperature & Heat Resistant Fiberglass Woven Plain & Drop-Warp (Bolt-Hole / LadderTape™) - Premium Grade					
Part Number	Width in / mm		Price per Roll By Thickness		
			"A" thickness Price / Weight (lb)	"B" thickness Price / Weight (lb)	"C" thickness Price / Weight (lb)
T-FG-WOVEN-P-0.500-M013-X-Z**	.5	13	\$ 34.20 / 1.0	\$ 44.43 / 2.2	NA
T-FG-WOVEN-P-0.750-M019-X-Z**	.75	19	\$ 49.60 / 1.6	\$ 55.70 / 3.2	\$ 88.87 / 6.9
T-FG-WOVEN-P-1.000-M025-X-Z	1.0	25	\$ 36.73 / 2.1	\$ 58.44 / 4.2	\$ 128.26 / 9.8
T-FG-WOVEN-P-1.250-M032-X-Z	1.25	32	\$ 38.73 / 2.5	\$ 59.73 / 5.2	\$ 146.83 / 12.6
T-FG-WOVEN-P-1.500-M038-X-Z	1.5	38	\$ 40.13 / 3.0	\$ 60.55 / 6.2	\$ 174.43 / 14.6
T-FG-WOVEN-P-2.000-M051-X-Z	2.0	51	\$ 44.73 / 4.1	\$ 70.80 / 8.2	\$ 188.71 / 19.5
T-FG-WOVEN-P-2.500-M064-X-Z	2.5	64	\$ 49.86 / 5.1	\$ 82.20 / 10.2	\$ 214.66 / 24.4
T-FG-WOVEN-P-3.000-M076-X-Z	3.0	76	\$ 58.23 / 6.2	\$ 99.20 / 12.2	\$ 244.70 / 29.3
T-FG-WOVEN-P-3.500-M089-X-Z	3.5	89	\$ 66.43 / 7.3	\$ 110.86 / 14.2	\$ 286.43 / 34.2
T-FG-WOVEN-P-4.000-M102-X-Z	4.0	102	\$ 75.60 / 8.2	\$ 123.16 / 16.5	\$ 303.16 / 39.0
T-FG-WOVEN-P-4.500-M114-X-Z	4.5	114	\$ 90.77 / 9.2	\$ 163.21 / 18.5	\$ 348.44 / 44.0
T-FG-WOVEN-P-5.000-M127-X-Z	5.0	127	\$ 92.73 / 10.3	\$ 169.93 / 20.5	\$ 379.46 / 48.8
T-FG-WOVEN-P-5.500-M140-X-Z	5.5	140	\$ 96.73 / 11.3	\$ 177.93 / 22.5	\$ 398.46 / 53.7
T-FG-WOVEN-P-6.000-M152-X-Z	6.0	152	\$ 117.03 / 12.3	\$ 187.46 / 24.5	\$ 423.10 / 58.6

- For the "X" Value, specify A, B or C in part number to correspond to the desired thickness
A = 1/16" / .0625" / 1.59mm **B** = 1/8" / .125" / 3.18mm **C** = 1/4" / .250" / 6.35mm
- For the "Z" value in part number: use "-P" for Plain style tape or "-DW" for Drop Warp style tape.
 Same price either version.
- All tapes are 100 foot / 30 metre lengths.
- Items with * may have higher minimum order quantities – please call.
- ** -08 / .5" / 13mm and -12 / .75" / 19mm width tapes are not available in Drop Warp
- Heat Treated / Heat Cleaned Available: low smoke – dimensionally set – exceptionally clean

Custom width tapes: Minimum 20 rolls or \$650 setup charge for lower quantities.

Woven Fiberglass Gasket / Thermal Insulating Tape:

Premium Grade with PSA Adhesive

1200°F / 648°C: DeltaGlass™ Very High Temperature & Heat Resistant Plain & Drop Warp (Bolt-Hole / Ladder Tape™) with Adhesive PSA



Manufactured of texturized fiberglass yarns, this tape will withstand temperatures up to 1200°F / 648°C in continuous service. 100% asbestos free, this tape is a bright white color.

This tape offers superior insulating properties as well as low chloride content.

Offered in *Plain* and *Drop Warp* (also known as *Bolt-Hole* or *LadderTape™*). Drop Warp tape has lengthwise yarns missing from the center of the tape to allow fasteners to pass through the tape for assembly onto access doors, etc.

A Heat Treated version of this product is available – please enquire. Also available without Pressure Sensitive Adhesive (PSA) (see previous page in catalog).

1200°F / 648°C continuous rating, high insulation value & excellent personnel protection

Very High Temperature & Heat Resistant Fiberglass Woven Plain & Drop-Warp / Bolt-Hole / LadderTape™ - Premium Grade with PSA Adhesive

Part Number	Width in / mm		Price per Roll By Thickness		
			"A" thickness Price	"B" thickness Price	"C" thickness Price
T-FG-WOVEN-P-0.500-M013-X-Z-PSA**	.5	13	\$ 77.17	\$ 87.40	NA
T-FG-WOVEN-P-0.750-M019-X-Z-PSA**	.75	19	\$ 83.63	\$ 92.60	\$ 137.03
T-FG-WOVEN-P-1.000-M025-X-Z-PSA	1.0	25	\$ 87.03	\$ 100.23	\$ 178.23
T-FG-WOVEN-P-1.250-M032-X-Z-PSA	1.25	32	\$ 97.88	\$ 117.03	\$ 193.50
T-FG-WOVEN-P-1.500-M038-X-Z-PSA	1.5	38	\$ 100.13	\$ 119.87	\$ 227.77
T-FG-WOVEN-P-2.000-M051-X-Z-PSA	2.0	51	\$ 111.50	\$ 137.27	\$ 252.83
T-FG-WOVEN-P-2.500-M064-X-Z-PSA	2.5	64	\$ 124.87	\$ 157.20	\$ 289.43
T-FG-WOVEN-P-3.000-M076-X-Z-PSA	3.0	76	\$ 139.46	\$ 180.70	\$ 326.36
T-FG-WOVEN-P-3.500-M089-X-Z-PSA	3.5	89	\$ 146.40	\$ 193.86	\$ 396.96
T-FG-WOVEN-P-4.000-M102-X-Z-PSA	4.0	102	\$ 185.46	\$ 216.00	\$ 396.73
T-FG-WOVEN-P-4.500-M114-X-Z-PSA	4.5	114	\$ 191.43	\$ 247.63	\$ 437.71
T-FG-WOVEN-P-5.000-M127-X-Z-PSA	5.0	127	\$ 212.33	\$ 281.20	\$ 491.40
T-FG-WOVEN-P-5.500-M140-X-Z-PSA	5.5	140	\$ 219.33	\$ 288.20	\$ 501.40
T-FG-WOVEN-P-6.000-M152-X-Z-PSA	6.0	152	\$ 227.36	\$ 295.23	\$ 518.20

- For the "X" Value, specify A, B or C in part number to correspond to the desired thickness
A = 1/16" / .0625" / 1.59mm **B** = 1/8" / .125" / 3.18mm **C** = 1/4" / .250" / 6.35mm
- For the "Z" value in part number: use "-P" for Plain style tape or "-DW" for Drop Warp style tape. Same price either version.
- All tapes are 100 foot / 30 metre lengths.
- Items with * may have higher minimum order quantities – please call.
- ** -08 / .5" / 13mm and -12 / .75" / 19mm width tapes are not available in Drop Warp
- Heat Treated / Heat Cleaned Available: low smoke – dimensionally set – exceptionally clean

Custom width tapes: Minimum 20 rolls or \$650 setup charge for lower quantities.

Fiberglass Woven Gasket & Thermal Insulating Tape: *Industrial Grade* 1200°F / 648°C: - Very High Temperature & Heat Resistant Plain & Drop-Warp (Bolt-Hole / Ladder Tape)



Manufactured of texturized fiberglass yarns, tape will withstand temperatures up to 1200°F / 648°C in continuous service.

This tape offers superior insulating properties as well as low chloride content.

Offered in *Plain* and *Drop Warp* (also known as *Bolt-Hole* or *LadderTape™*). Drop Warp tape has lengthwise yarns missing from the center of the tape to allow fasteners to pass through the tape for assembly onto access doors, etc. This is also called a Ladder or Bolthole tape.

A Heat Treated version of this product is available.

Industrial grade tape has a lower bulk than Premium grade (the same size tape weighs more in Premium grade than Industrial grade as it has more fibreglass content). Available with and without Pressure Sensitive Adhesive (PSA).

1200°F / 648°C continuous rating, high insulation value & excellent personnel protection

Very High Temperature & Heat Resistant Fiberglass Woven Plain & Bolt-Hole / Drop-Warp / LadderTape™ - Industrial Grade					
Part Number	Width in / mm		Price per Roll By Thickness: A / B / C		
			"A" thickness no PSA / with PSA	"B" thickness no PSA / with PSA	"C" thickness no PSA / with PSA
T-FG-WOVEN-I-0.500-M013-X-Z**	.5	13	\$ 102.63 / \$ 218.13	\$ 37.30 / \$ 80.26	N/A / NA
T-FG-WOVEN-I-0.750-M019-X-Z**	.75	19	\$ 20.46 / \$ 69.40	\$ 38.74 / \$ 86.22	N/A / NA
T-FG-WOVEN-I-1.000-M025-X-Z	1.0	25	\$ 23.90 / \$ 74.16	\$ 38.56 / \$ 88.43	\$ 57.35 / N/A
T-FG-WOVEN-I-1.250-M032-X-Z	1.25	32	\$ 29.63 / \$ 88.53	\$ 43.80 / \$ 99.20	N/A / NA
T-FG-WOVEN-I-1.500-M038-X-Z	1.5	38	\$ 29.86 / \$ 89.46	\$ 45.48 / \$ 108.06	N/A / NA
T-FG-WOVEN-I-2.000-M051-X-Z	2.0	51	\$ 34.43 / \$ 101.76	\$ 50.50 / \$ 117.83	\$ 67.21 / N/A
T-FG-WOVEN-I-2.500-M064-X-Z	2.5	64	\$ 48.63 / \$ 123.16	\$ 65.80 / \$ 140.96	N/A / NA
T-FG-WOVEN-I-3.000-M076-X-Z	3.0	76	\$ 53.03 / \$ 135.23	\$ 67.10 / \$ 147.50	\$ 84.81 / N/A
T-FG-WOVEN-I-3.500-M089-X-Z	3.5	89	\$ 59.66 / \$ 141.13	\$ 78.66 / \$ 156.13	N/A / NA
T-FG-WOVEN-I-4.000-M102-X-Z	4.0	102	\$ 63.16 / \$ 157.93	\$ 87.76 / \$ 168.53	N/A / NA
T-FG-WOVEN-I-4.500-M114-X-Z	4.5	114	\$ 71.46 / \$ 169.93	\$ 94.51 / \$ 188.79	N/A / NA
T-FG-WOVEN-I-5.000-M127-X-Z	5.0	127	\$ 79.53 / \$ 191.70	\$ 109.80 / \$ 203.96	N/A / NA
T-FG-WOVEN-I-5.500-M140-X-Z	5.5	140	\$ 92.17 / \$ 201.33	\$ 120.27 / \$ 217.31	N/A / NA
T-FG-WOVEN-I-6.000-M152-X-Z	6.0	152	\$ 108.73 / \$ 213.00	\$ 126.36 / \$ 229.63	N/A / NA

- For the "X" value, specify "A" or "B" in part number to correspond to the desired thickness
A = 1/16" / .0625" / 1.59mm **B** = 1/8" / .125" / 3.18mm **C** = 1/4" / .250" / 6.35mm
- For "Z" value in part number: use "-P" for Plain style tape or "-DW" for Drop Warp style tape
 Same price either version. Not all sizes available in drop warp style.
- All tapes are 100 foot / 30 metre lengths.
- Items with * may have higher minimum order quantities – please call.
- ** .5"/13mm and .75"/19mm width tapes are not available in Drop Warp

Fiberglass Woven Gasket & Thermal Insulating Tape: *Heat Treated – Heat Cleaned*

1200°F / 648°C: Very High Temperature & Heat Resistant Plain Tape



Manufactured of texturized fiberglass yarns, tape will withstand temperatures up to 1200°F / 648°C in continuous service.

This tape offers superior insulating properties as well as low chloride content.

Heat Treated / Heat Cleaned tapes have very low smoke off when installed in high temperature applications, as the organics have been already mostly removed. Heat treating also sets the tape dimensionally.

1200°F / 648°C continuous rating, high insulation value & excellent personnel protection

Very High Temperature & Heat Resistant Fiberglass Woven Plain Tape: Heat Treated / Heat Cleaned			
Part Number	Width in / mm		Price per Roll
T-FG-WOVEN-HT-1.000-M025	1.0	25	\$ 48.56
T-FG-WOVEN-HT-2.000-M051	2.0	51	\$ 62.50
T-FG-WOVEN-HT-2.500-M064	2.5	64	\$ 79.80
T-FG-WOVEN-HT-3.000-M076	3.0	76	\$ 81.10
T-FG-WOVEN-HT-4.000-M102	4.0	102	\$ 107.76

These are common ordered sizes: any of our tapes can be heat-treated/heat cleaned

- Tape thickness is .100"
- All tapes are 100 foot / 30 metre lengths.

Fiberglass Woven Gasket & Thermal Insulating Tape:

Premium Grade / Special Thin

1200°F / 648°C: Very High Temperature & Heat Resistant Plain & Bolt-Hole / LadderTape™



Manufactured of texturized fiberglass yarns, this tape will withstand temperatures up to 1200°F / 648°C in continuous service.

This tape offers superior insulating properties as well as low chloride content.

Offered in *Plain* and *Drop Warp* (also known as *Bolt-Hole* or *LadderTape™*). Drop Warp tape has lengthwise yarns missing from the center of the tape to allow fasteners to pass through the tape for assembly onto access doors, etc.

A Heat Treated version of this product is available – please enquire

1200°F / 648°C continuous rating, high insulation value & excellent personnel protection

Very High Temperature & Heat Resistant Fiberglass Woven Plain & Bolt-Hole / Drop-Warp / LadderTape™ Premium Grade / Special Thin 1/32" / .0313" / 0.8mm Thickness				
Part Number	Width in / mm		Price per Roll	
			no PSA	with PSA
T-FG-WOVEN-P-THIN-0.500-M013-X**	.5	13	\$ 16.88	\$ 27.43
T-FG-WOVEN-P-THIN-1.000-M025-X	1.0	25	\$ 24.20	\$ 37.23
T-FG-WOVEN-P-THIN-1.500-M038-X	1.5	38	\$ 31.40	\$ 54.13
T-FG-WOVEN-P-THIN-2.000-M051-X	2.0	51	\$ 37.73	\$ 65.33
T-FG-WOVEN-P-THIN-2.500-M064-X	2.5	64	\$ 45.10	\$ 85.90
T-FG-WOVEN-P-THIN-3.000-M076-X	3.0	76	\$ 52.53	\$ 106.37
T-FG-WOVEN-P-THIN-3.500-M089-X	3.5	89	\$ 60.47	\$ 120.86
T-FG-WOVEN-P-THIN-4.000-M102-X	4.0	102	\$ 67.80	\$ 135.40
T-FG-WOVEN-P-THIN-4.500-M114-X	4.5	114	\$ 75.63	\$ 149.30
T-FG-WOVEN-P-THIN-5.000-M127-X	5.0	127	\$ 82.73	\$ 163.13
T-FG-WOVEN-P-THIN-5.500-M140-X	5.5	140	\$ 89.96	\$ 176.47
T-FG-WOVEN-P-THIN-6.000-M152-X	6.0	152	\$ 96.90	\$ 189.80

- This tape is 1/32" / .0313" / 0.8mm thick
- For the "X" value in part number: use "-P" for Plain style tape
or "-DW" for Drop Warp style tape.

Same price either style.

- Add "-PSA" to the part number for tape with PSA coating.
- All tapes are 100 foot / 30 metre lengths.
- ** -08 / .5" / 13mm width tapes are not available in Drop Warp

**Fiberglass Colored Woven Tape:
 1200°F / 648°C: Very High Temperature & Heat Resistant: Industrial Grade**



Manufactured of texturized fiberglass yarns, tape will withstand temperatures up to 1200°F / 648°C in continuous service.

tape offers superior insulating properties as well as low chloride content.

Color coded tapes are an excellent solution for identifying hoses and pipes, for example, as supply (hotter) or return (cooler).

Available in Black, Blue, Red, Green, Silver

Only available in 1/16" thick.

1200°F / 648°C continuous rating, high insulation value & excellent personnel protection

Very High Temperature & Heat Resistant Fiberglass Woven Color Coded Tape			
Part Number	Width in / mm		Price per Roll By Length
			15 feet / 25 feet / 50 feet
T-FG-WOVEN-CC-1.000-M025-A-X-Y	1.0	25	\$ 12.41 / \$ 18.60 / \$ 34.87
T-FG-WOVEN-CC-2.000-M051-A-X-Y	2.0	51	\$ 21.89 / \$ 33.64 / \$ 63.62

- For the "X" value, specify "BK" for black; "BL" for blue; "R" for red; "G" for green; "S" for silver/grey.
- For the "Y" value, add the length to the part number; -15, -25, -50

MINIMUM ORDER 200 ROLLS

ProSil™ Silica/Glass Blend Woven Gasket & Thermal Insulating Tape

1350°F / 732°C: FlameShield™ 1500 Very High Temperature & Heat Resistant
Plain & Bolt-Hole / LadderTape™



ProSil™ Silica/Glass blended tape is a proprietary mixed yarn tape that remains soft and workable at temperatures where fiberglass tapes become brittle.

Withstands temperatures up to 1350°F / 732°C constant exposure.

Offered in *Plain* and *Drop Warp* (also known as *Bolt-Hole* or *LadderTape™*). Drop Warp tape has lengthwise yarns missing from the center of the tape to allow fasteners to pass through the tape for assembly onto access doors, etc. This is also called a Ladder or Bolthole tape.

Available with an acrylic Pressure Sensitive Adhesive (PSA) designed to aid in placement of the tape in gasket applications. The PSA will smoke off at temperatures above 425°F / 218°C.

ProSil™ Silica/Glass Blend Woven Gasket & Thermal Insulating Tape
1350°F / 732°C: FlameShield™ 1500 Very High Temperature & Heat Resistant Plain & Bolt-Hole / LadderTape™



1350°F / 732°C continuous rating, high insulation value & excellent personnel protection

Very High Temperature & Heat Resistant ProSil™ Silica/Glass Blended Tape Plain & Bolt-Hole / Drop-Warp / LadderTape™				
Part Number	Width in / mm		1/16" / 1/8" thickness	1/16" / 1/8" thickness
			Plain & Drop Warp No PSA	Plain & Drop Warp with PSA
T-FG+SIL-WOVEN-0.5-M013-X-Z	.5	13	\$ 28.08 / \$ 51.84	\$ 49.56 / \$ 80.52
T-FG+SIL-WOVEN-1.0-M025-X-Z	1.0	25	\$ 36.84 / \$ 75.15	\$ 68.40 / \$ 116.04
T-FG+SIL-WOVEN-1.5-M038-X-Z	1.5	38	\$ 52.29 / \$ 106.29	\$ 96.63 / \$ 166.92
T-FG+SIL-WOVEN-2.0-M051-X-Z	2.0	51	\$ 67.80 / \$ 139.32	\$ 122.82 / \$ 215.76
T-FG+SIL-WOVEN-2.5-M064-X-Z	2.5	64	\$ 83.34 / \$ 172.50	\$ 159.87 / \$ 276.18
T-FG+SIL-WOVEN-3.0-M076-X-Z	3.0	76	\$ 98.64 / \$ 205.62	\$ 196.56 / \$ 336.60
T-FG+SIL-WOVEN-3.5-M089-X-Z	3.5	89	\$ 114.12 / \$ 238.71	\$ 224.88 / \$ 387.69
T-FG+SIL-WOVEN-4.0-M102-X-Z	4.0	102	\$ 129.57 / \$ 271.71	\$ 253.20 / \$ 438.72
T-FG+SIL-WOVEN-4.5-M114-X-Z	4.5	114	\$ 152.22 / \$ 312.42	\$ 291.03 / \$ 499.98
T-FG+SIL-WOVEN-5.0-M127-X-Z	5.0	127	\$ 174.84 / \$ 353.13	\$ 328.74 / \$ 561.18
T-FG+SIL-WOVEN-5.5-M140-X-Z	5.5	102	\$ 190.50 / \$ 393.63	\$ 356.91 / \$ 621.39
T-FG+SIL-WOVEN-6.0-M152-X-Z	6.0	152	\$ 206.13 / \$ 434.10	\$ 385.02 / \$ 681.69

- Roll length is 100 feet / 30 metres.
- For the "X" value, specify "A" or "B" in part number to correspond to the desired thickness.
 A = 1/16" / .0625" / 1.59mm B = 1/8" / .125" / 3.18mm
- For the "Z" value in part number: use "-P" for Plain style tape or "-DW" for Drop Warp style tape
 Same price either style.
- Add "-PSA" to the part number for tape with PSA coating.

Fiberglass Woven Gasket & Thermal Insulating Tape with Vermiculite Coating: *Premium Grade*
1500°F / 815°C: FlameShield™ 1500 Very High Temperature & Heat Resistant Plain & Bolt-Hole / LadderTape™



Plain tape shown on the left - Drop-Warp / Bolt Hole / Ladder tape shown on the right

Vermiculite coated fiberglass tape is manufactured from texturized fiberglass yarns then coated with Vermiculite, a 100% inorganic dispersion. Certified to meet the requirements of ASTM E 162, ASTM E 662 & SMP 800-C for surface flammability, smoke and toxic gas generation.

Vermiculite coated tape will withstand temperatures up to 1500°F / 815°C constant exposure with excursions to 2000°F / 1093°F. Also offers additional abrasion resistance and stiffness.

Offered in *Plain* and *Drop Warp (also known as Bolt-Hole or LadderTape™)*. Drop Warp tape has lengthwise yarns missing from the center of the tape to allow fasteners to pass through the tape for assembly onto access doors, etc. This is also called a Ladder-Tape or Bolt-hole tape.

Available with and without Pressure Sensitive Adhesive (PSA). Meets Federal Railroad Administration requirements for surface flammability and rate of smoke generation.

**Fiberglass Woven Gasket & Thermal Insulating Tape with Vermiculite Coating:
Premium Grade (Continued)**



1500°F / 815°C continuous rating, high insulation value & excellent personnel protection

**Very High Temperature & Heat Resistant Vermiculite Coated Fiberglass Tape
Premium Grade Plain & Bolt-Hole / Drop-Warp / LadderTape™**

Part Number	Width in / mm		A / B / C thickness Plain & Drop Warp No PSA	A / B / C thickness Plain & Drop Warp with PSA
T-FG-VC-WOVEN-P-M013-08-X-Z**	.5	13	\$ 79.50 / \$ 93.33 / NA	\$ 122.47 / \$ 136.30 / NA
T-FG-VC-WOVEN-P-M019-12-X-Z**	.75	19	\$ 81.20 / \$ 96.67 / \$ 153.30	\$ 123.97 / \$ 141.50 / \$ 201.47
T-FG-VC-WOVEN-P-M025-16-X-Z	1.0	25	\$ 82.93 / \$ 99.83 / \$ 206.50	\$ 133.23 / \$ 150.80 / \$ 256.13
T-FG-VC-WOVEN-P-M032-20-X-Z	1.25	32	\$ 85.57 / \$ 111.27 / \$ 231.57	\$ 144.87 / \$ 170.57 / \$ 290.87
T-FG-VC-WOVEN-P-M038-24-X-Z	1.5	38	\$ 87.50 / \$ 114.58 / \$ 268.83	\$ 147.62 / \$ 178.65 / \$ 322.17
T-FG-VC-WOVEN-P-M051-32-X-Z	2.0	51	\$ 93.67 / \$ 128.90 / \$ 288.07	\$ 160.47 / \$ 195.37 / \$ 354.87
T-FG-VC-WOVEN-P-M064-40-X-Z	2.5	64	\$ 100.67 / \$ 144.31 / \$ 323.03	\$ 175.66 / \$ 219.32 / \$ 398.03
T-FG-VC-WOVEN-P-M076-48-X-Z	3.0	76	\$ 111.93 / \$ 167.03 / \$ 366.33	\$ 193.17 / \$ 446.67 / \$ 467.96
T-FG-VC-WOVEN-P-M089-56-X-Z	3.5	89	\$ 123.03 / \$ 182.11 / \$ 398.78	\$ 206.33 / \$ 265.40 / \$ 497.58
T-FG-VC-WOVEN-P-M102-64-X-Z	4.0	102	\$ 135.40 / \$ 198.20 / \$ 443.17	\$ 248.60 / \$ 292.56 / \$ 506.33
T-FG-VC-WOVEN-P-M127-80-X-Z	5.0	127	\$ 157.57 / \$ 262.73 / \$ 535.66	\$ 278.20 / \$ 374.67 / \$ 647.53
T-FG-VC-WOVEN-P-M152-96-X-Z	6.0	152	\$ 162.97 / \$ 286.43 / \$ 590.50	\$ 294.30 / \$ 384.40 / \$ 688.51

- For the "X" value, specify A, B or C in part number to correspond to the desired thickness
A = 1/16" / .0625" / 1.59mm B = 1/8" / .125" / 3.18mm C = 1/4" / .250" / 6.35mm
- For "Z" value in part number: use "-P" for Plain style tape or "-DW" for Drop Warp style tape.
Same price either style.
- Add "-PSA" to the part number for tape with PSA coating.
- 1/16" and 1/8" thick tapes are 100 foot lengths. For 1/4" thick tapes, larger widths may be available in 50 foot lengths.
- ** -08 / .5" / 13mm and -12 / .75" / 19mm width tapes are not available in Drop Warp

**Fiberglass Woven Gasket & Thermal Insulating Tape with Vermiculite
Coating: *Industrial Grade*
1500°F / 815°C: FlameShield™ 1500 Very High Temperature & Heat Resistant Plain &
Bolt-Hole / LadderTape™**



Vermiculite coated fiberglass tape is manufactured from texturized fiberglass yarns then coated with Vermiculite, a 100% inorganic dispersion. Certified to meet the requirements of ASTM E 162, ASTM E 662 & SMP 800-C for surface flammability, smoke and toxic gas generation.

Vermiculite coated tape will withstand temperatures up to 1500°F / 815°C constant exposure with excursions to 2000°F / 1093°F. Also offers abrasion resistant stability.

Offered in *Plain* and *Drop Warp* (also known as *Bolt-Hole* or *LadderTape™*). Drop Warp tape has lengthwise yarns missing from the center of the tape to allow fasteners to pass through the tape for assembly onto access doors, etc. This is also called a Ladder or Bolthole tape.

Available with and without Pressure Sensitive Adhesive (PSA). Meets Federal Railroad Administration requirements for surface flammability and rate of smoke generation.

Fiberglass Woven Gasket & Thermal Insulating Tape with Vermiculite Coating: *Industrial Grade (Continued)*



1500°F / 815°C continuous rating, high insulation value & excellent personnel protection

Very High Temperature & Heat Resistant Vermiculite Coated Fiberglass Tape Industrial Grade Plain & Bolt-Hole / Drop-Warp / LadderTape™

Part Number	Width in / mm		A / B thickness Plain & Drop Warp No PSA	A / B thickness Plain & Drop Warp with PSA
	T-FG-VC-WOVEN-I-M013-08-X-Z	.5	13	\$ 366.57* NOTE / \$ 85.56
T-FG-VC-WOVEN-I-M019-12-X-Z	.75	19	\$ 62.53 / \$ 164.93	\$ 110.70 / \$ 244.61
T-FG-VC-WOVEN-I-M025-16-X-Z	1.0	25	\$ 66.84 / \$ 87.37	\$ 117.13 / \$ 139.00
T-FG-VC-WOVEN-I-M032-20-X-Z	1.25	32	\$ 73.60 / \$ 94.67	\$ 132.90 / \$ 150.63
T-FG-VC-WOVEN-I-M038-24-X-Z	1.5	38	\$ 75.06 / \$ 96.90	\$ 135.07 / \$ 156.90
T-FG-VC-WOVEN-I-M051-32-X-Z	2.0	51	\$ 81.40 / \$ 104.03	\$ 148.20 / \$ 170.83
T-FG-VC-WOVEN-I-M064-40-X-Z	2.5	64	\$ 101.43 / \$ 124.90	\$ 176.43 / \$ 198.79
T-FG-VC-WOVEN-I-M076-48-X-Z	3.0	76	\$ 108.50 / \$ 126.23	\$ 190.07 / \$ 207.81
T-FG-VC-WOVEN-I-M089-56-X-Z	3.5	89	\$ 114.96 / \$ 136.23	\$ 198.27 / \$ 219.53
T-FG-VC-WOVEN-I-M102-64-X-Z	4.0	102	\$ 122.71 / \$ 146.17	\$ 215.87 / \$ 239.33
T-FG-VC-WOVEN-I-M127-80-X-Z	5.0	127	\$ 145.13 / \$ 164.80	\$ 258.07 / \$ 294.47
T-FG-VC-WOVEN-I-M152-96-X-Z	6.0	152	\$ 150.27 / \$ 185.37	\$ 281.80 / \$ 316.70

- For the "X" value, specify "A" or "B" in part number to correspond to the desired thickness.
 A = 1/16" / .0625" / 1.59mm B = 1/8" / .125" / 3.18mm
- For "Z" value in part number: use "-P" for Plain style tape or "-DW" for Drop Warp style tape
 Same price either style.
- Drop Warp not available in 1/2 and 3/4 inch widths.
- * NOTE: 0.5" wide x 1/16" tape roll is 500 feet in length.

Fiberglass Woven Gasket & Thermal Insulating Tape with Vermiculite Coating: *Premium Grade / Special Thin*

1500°F / 815°C: FlameShield™ 1500 Very High Temperature & Heat Resistant Plain & Bolt-Hole / LadderTape™



Vermiculite coated fibreglass tape is manufactured from texturized fiberglass yarns then coated with Vermiculite, a 100% inorganic dispersion. Certified to meet the requirements of ASTM E 162, ASTM E 662 & SMP 800-C for surface flammability, smoke and toxic gas generation.

Vermiculite coated tape will withstand temperatures up to 1500°F / 815°C constant exposure with excursions to 2000°F / 1093°F. Also offers additional abrasion resistance and stiffness.

Offered in *Plain* and *Drop Warp* (also known as *Bolt-Hole* or *LadderTape™*). Drop Warp tape has lengthwise yarns missing from the center of the tape to allow fasteners to pass through the tape for assembly onto access doors, etc. This is also called a Ladder Tape or Bolt-hole tape.

Available with and without Pressure Sensitive Adhesive (PSA). Meets Federal Railroad Administration requirements for surface flammability and rate of smoke generation.

1500°F / 815°C continuous rating, high insulation value & excellent personnel protection

Very High Temperature & Heat Resistant Fiberglass Woven Plain & Bolt-Hole / Drop-Warp / LadderTape™ Premium Grade / Special Thin 1/32" / .0313" / 0.8mm Thickness				
Part Number	Width in / mm		Price per Roll	
			no PSA	with PSA
T-FG-VC-WOVEN-P-T-M013-08-X	.5	13	\$ 26.43	\$ 36.53
T-FG-VC-WOVEN-P-T-M025-16-X	1.0	25	\$ 35.10	\$ 49.30
T-FG-VC-WOVEN-P-T-M038-24-X	1.5	38	\$ 48.73	\$ 70.83
T-FG-VC-WOVEN-P-T-M051-32-X	2.0	51	\$ 58.63	\$ 85.43
T-FG-VC-WOVEN-P-T-M064-40-X	2.5	64	\$ 70.13	\$ 109.66
T-FG-VC-WOVEN-P-T-M076-48-X	3.0	76	\$ 81.50	\$ 133.83
T-FG-VC-WOVEN-P-T-M089-56-X	3.5	89	\$ 93.90	\$ 152.57
T-FG-VC-WOVEN-P-T-M102-64-X	4.0	102	\$ 106.36	\$ 171.33
T-FG-VC-WOVEN-P-T-M114-72-X	4.5	114	\$ 117.40	\$ 188.96
T-FG-VC-WOVEN-P-T-M127-80-X	5.0	127	\$ 128.53	\$ 206.60
T-FG-VC-WOVEN-P-T-M140-88-X	5.5	140	\$ 139.56	\$ 226.33
T-FG-VC-WOVEN-P-T-M152-96-X	6.0	152	\$ 150.57	\$ 240.70

- This tape is 1/32" / .0313" / 0.8mm thick
- For the "X" value in part number: use "-P" for Plain style tape or "-DW" for Drop Warp style tape.
- Add "-PSA" to the part number for tape with PSA coating.
- All tapes are 100 foot lengths.

Automotive Manifold, Header, Turbo & Exhaust Pipe Heat Insulating Tape & Wrap

1100°F / 593°C to 1500°F / 815°C: PowerTorque™ Tape

SilverGuard™ Fiberglass Woven Tape.

GoldGuard™ Fiberglass Woven Tape with Vermiculite Coating Tape.

BlackMax™ Fiberglass Woven Tape with Black Vermiculite Coating Tape.



Manifold and header wrapping is widely accepted as standard practice for performance auto and racing applications. There are two reasons for this. First, by adding an insulation layer around the exhaust gas pipig, it keeps the temperature of the gas from dropping, which means the density of the gas is kept lower longer, and lower density means easier flow through the exhaust system. Easier flow means more horse power due to reduced back pressure.

Retaining heat in the exhaust flow, resulting in faster exhaust gas flow, also results in higher turbo charger spool speeds, resulting in a gain of horse power.

Second, wrapping exhaust system components also reduces the temperature of other under-hood components and systems, reducing both radiated heat and convective heating of electrical components, intake air, fuel and hydraulic hoses. Reducing under-hood temperature also helps reduce hood paint thermal damage.

PowerTorque™ Very High Temperature & Heat Resistant Manifold, Header, Turbo & Exhaust Pipe Wrapping Tape SilverGuard™ ,GoldGuard™ and BlackMax™			
Part Number	Width in / mm		Price per Rol 25 ft / 50 ft / 100 ft
PowerTorque™ SilverGuard™ Tape			
T-FG-SG-M025-16-X	1.0	25	\$ 6.59 / \$ 12.55 / \$ 23.90
T-FG-SG-M051-32-X	2.0	50	\$ 9.67 / \$ 18.43 / \$ 34.43
PowerTorque™ GoldGuard™ Tape			
T-FG-GG-M025-16-X	1.0	25	\$ 19.67 / \$ 37.81 / \$ 66.84
T-FG-GG-M051-32-X	2.0	50	\$ 25.64 / \$ 46.71 / \$ 81.40
PowerTorque™ BlackMax™ Tape			
T-FG-BM-M025-16-X	1.0	25	\$ 8.99 / \$ 16.97 / \$ 31.93
T-FG-BM-M051-32-X	2.0	50	\$ 16.24 / \$ 31.37 / \$ 59.85

SilverGuard™ tape is Bright White, GoldGuard™ is a Tan/Gold color and BlackMax™ is Black

In the part number, replace the "X" value with the length of the tape: i.e.; 25, 50, 100

Stainless Steel Free End Self Locking Clamps: Used to secure tape in place. Makes a neat low profile installation. (standard hand tools can be used to tighten and cut the remaining free end)

- SSFCSL-WM005-XX. .181" width clamp. 6" \$1.21, 8" \$1.39, 14" \$1.59, 20" \$2.11
- SSFCSL-WM008-XX. .311" width clamp. 8" \$1.59, 14" \$2.29, 20" \$3.87

Silica Slit Gasket & Thermal Insulating Tape

1800°F / 982°C: InSilMax™ Extreme High Temperature, Heat, Flame, Molten Metal & Weld Splatter Resistant

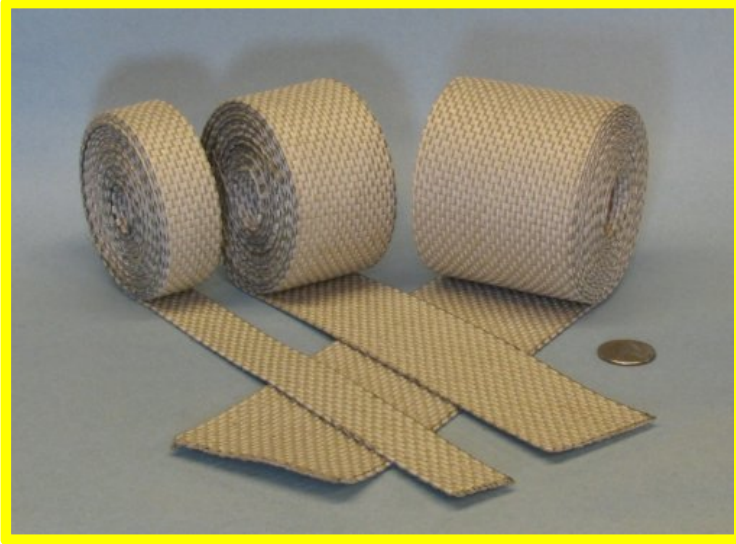

An alternative to asbestos and ceramic based textiles. Highly flexible and minimal shrinkage. High abrasion resistance and tensile strength. Melts above 3000°F / 1648°C. Available with a PSA (pressure sensitive adhesive) to facilitate easy installation (*see note).

Produced from an extremely pure silica base fiber (SiO₂) and can be used at 2000°F / 1093°C continuously with excursions to 3000°F / 1650°C.

Weave is tight, but edge fray is possible with slit tapes. For non fray edges use a woven tape.

1, 2 and 3 inch tapes shown

InSilMax™ Extreme Temperature, Heat, Flame, Molten Metal & Weld Splatter Resistant Silica Tapes					
0.090" / 2.3mm Thick Tape					
Part Number	Width inch / mm / dash #			Price per foot / Metre 25 & 50 foot Standard Roll	
T-S-SLIT-M025-16	1"	25	-16	\$ 1.32	\$ 4.33
T-S-SLIT-M032-20	1 1/4"	32	-20	\$ 1.52	\$ 4.98
T-S-SLIT-M038-24	1 1/2"	38	-24	\$ 1.68	\$ 5.51
T-S-SLIT-M051-32	2"	51	-32	\$ 2.04	\$ 6.69
T-S-SLIT-M064-40	2 1/2"	64	-40	\$ 3.08	\$ 10.10
T-S-SLIT-M076-48	3"	76	-48	\$ 3.72	\$ 12.20
T-S-SLIT-M102-64	4"	102	-64	\$ 4.98	\$ 16.33
T-S-SLIT-M127-80	5"	127	-80	\$ 5.80	\$ 19.02
T-S-SLIT-M152-96	6"	152	-96	\$ 6.63	\$ 21.75

Available in standard 25 foot / 7.6 metre or 50 foot / 15.2 metre rolls
For other lengths add +25% to price shown

* Note: The PSA will burn off at temperatures above 400°F and should be used to facilitate installation. Material with PSA should not be used in confined areas at elevated temperatures without ventilation until all of the PSA has vaporized.

To aid in mounting this tape onto surfaces, FlangeStik™ pressure sensitive adhesive spray can be used to place the tape in situ temporarily. Permanent fasteners or grab strips should be installed prior to heating of the area sprayed above 200°F. The adhesive will "smoke-off" at elevated temperatures.

This Product is Available By-The-Foot / Metre

Fine Weave Silica Slit Gasket & Thermal Insulating Tape

With PSA Adhesive

1800°F / 982°C: InSilMax™ Extreme High Temperature, Heat, Flame, Molten Metal & Weld Splatter Resistant



An alternative to asbestos and ceramic based textiles. Highly flexible and minimal shrinkage. High abrasion resistance and tensile strength. Melts above 3000°F / 1648°C. Acrylic PSA adhesive to facilitate easy installation (*see note).

Produced from an extremely pure silica base fiber (SiO₂) and can be used at 1800°F / 982°C continuously with excursions to 3000°F / 1650°C.

The base fabric is a fine weave, but edge fray is possible with slit tapes. As this tape has an adhesive coating the fray is minimized.

1, 2 and 3 inch tapes shown

InSilMax™ Extreme Temperature, Heat, Flame, Molten Metal & Weld Splatter Resistant Fine Weave Silica Tape with Adhesive				
0.030" / .76mm Thick Tape				
Part Number	Width inch / mm / dash #			Price per Roll
T-S-FWADH-SLIT-M025-16	1"	25	-16	\$ 131.25
T-S-FWADH-SLIT-M038-24	1 1/2"	38	-24	\$ 195.00
T-S-FWADH-SLIT-M051-32	2"	51	-32	\$ 247.50
Other widths available - please inquire – priced at \$131.25 per inch-width				

Roll length 150 feet / 45 metres

* Note: The PSA will burn off at temperatures above 400°F and should be used to facilitate installation. Material with PSA should not be used in confined areas at elevated temperatures without ventilation until all of the PSA has vaporized.

Silica Folded & Stitched Gasket & Thermal Insulating Tape

1800°F / 982°C: InSilMax™ Extreme High Temperature, Heat, Flame, Molten Metal & Weld Splatter Resistant



An alternative to asbestos and ceramic based textiles. Highly flexible and minimal shrinkage. High abrasion resistance and tensile strength. Melts above 3000°F / 1648°C. Available with a PSA (pressure sensitive adhesive) to facilitate easy installation (*see note).

Produced from an extremely pure silica base fiber (SiO₂) and can be used at 1800°F / 982°C continuously with excursions to 3000°F / 1650°C.

Folded & Stitched tape is a thicker alternative to Slit Tape. Top roll in photo is one layer slit tape; 2nd roll from top is 2 layer folded and stitched; 3rd roll from top is three layer folded and stitched and bottom roll is 4 layer folded and stitched. All tapes are same length.

InSilMax™ Extreme Temperature, Heat, Flame, Molten Metal & Weld Splatter Resistant Folded & Stitched Silica Tape						
Folded & Stitched Silica Tape – 25 or 50 foot roll						
Available in 3 thicknesses: 1/8" / 3.2mm thick • 3/16" / 4.8mm thick • 1/4" / 6.4mm thick						
Width inch / mm / dash #			Part Number	1/8" / 3.2mm Price / Ft / m x value = 2	3/16" / 4.8mm Price / Ft / m x value = 3	1/4" / 6.4mm Price / Ft / m x value = 4
1"	25	-16	T-S-F-M025-16-X	\$3.44 / \$11.28	\$4.68 / \$15.35	\$5.98 / \$19.61
1 1/4"	32	-20	T-S-F-M032-20-X	\$4.12 / \$13.51	\$5.68 / \$18.63	\$7.24 / \$23.74
1 1/2"	38	-24	T-S-F-M038-24-X	\$4.76 / \$15.61	\$6.56 / \$21.52	\$8.52 / \$27.95
2"	51	-32	T-S-F-M051-32-X	\$6.36 / \$20.86	\$8.96 / \$29.39	\$15.64 / \$51.30
2 1/2"	64	-40	T-S-F-M064-40-X	\$7.32 / \$24.01	\$9.04 / \$29.65	\$14.72 / \$48.28
3"	76	-48	T-S-F-M076-48-X	\$8.56 / \$28.08	\$12.36 / \$40.54	\$16.12 / \$52.87
4"	102	-64	T-S-F-M102-64-X	\$11.04 / \$36.21	\$16.12 / \$52.87	\$23.60 / \$77.41
5"	127	-80	T-S-F-M127-80-X	\$13.64 / \$44.74	\$19.97 / \$65.50	\$26.32 / \$86.33
6"	152	-96	T-S-F-M152-96-X	\$16.12 / \$52.87	\$23.76 / \$77.93	\$31.32 / \$102.73
8"	203	-102	T-S-F-M203-102-X	\$21.88 / \$71.77	\$33.20 / \$108.90	\$43.80 / \$143.66

For other than standard lengths, add 20% to the price shown

**For the "X" value in the part number: specify "2" for 1/8" thick tape
 "3" for 3/16" thick tape
 "4" for 1/4" thick tape**

Add "-P" to the part number to order tape with PSA on one side.

* Note: The PSA will burn off at temperatures above 400°F and should be used to facilitate installation. Material with PSA should not be used in confined areas at elevated temperatures without ventilation until all of the PSA has vaporized.

To aid in mounting this tape onto surfaces, FlangeStik™ pressure sensitive adhesive spray can be used to place the tape in situ temporarily. Permanent fasteners or grab strips should be installed prior to heating of the area sprayed above 200°F. The adhesive will "smoke-off" at elevated temperatures.

Silica Woven Gasket & Thermal Insulating Tape

1800°F / 982°C: InSilMax™ Extreme High Temperature, Heat, Flame, Molten Metal & Weld Splatter Resistant



Available in Plain and Drop Warp (also known as Ladder Tape™ or Bolt-Hole Tape).

An alternative to asbestos and ceramic based textiles. Highly flexible and minimal shrinkage. High abrasion resistance and tensile strength. Melts above 3000°F / 1648°C. Available with a PSA (pressure sensitive adhesive) to facilitate easy installation (*see note).

Woven tape has the benefit over slit tape of edges that will not fray unless cut.

For a tape with less shrinkage and deterioration at maximum temperature, use InSilMax XT tape, part number IXTSWT shown on the next page in the catalogue.

Common applications for this tape are as a gasket and seal material on high temperature access doors, inspection and clean-out doors and panels for kilns, ovens, furnaces, ventilation systems, etc.

InSilMax™ Extreme Temperature, Heat, Flame, Molten Metal & Weld Splatter Resistant Woven Silica Tapes						
Plain & Drop Warp Woven Silica Tape – 100 foot roll						
Available in 3 thicknesses: 1/16" / 2mm thick • 1/8" / 3.2mm thick • 1/4" / 6.4mm thick						
Width inch / mm / dash #			Part Number	1/16" / 2mm Price per foot no PSA / with PSA	1/8" / 3.2mm Price per foot no PSA / with PSA	1/4" / 6.4mm Price per foot no PSA / with PSA
1"	25	-16	T-S-WOVEN-M025-16-X-Z	\$ 1.77 / \$ 2.15	\$ 4.02 / \$ 4.55	\$ 5.04 / \$ 5.56
1 1/2"	38	-24	T-S-WOVEN-M038-24-X-Z	\$ 2.47 / \$ 3.03	\$ 5.64 / \$ 6.42	\$ 7.36 / \$ 8.14
2"	51	-32	T-S-WOVEN-M051-32-X-Z	\$ 3.21 / \$ 3.91	\$ 7.41 / \$ 8.44	\$ 9.68 / \$ 10.66
3"	76	-48	T-S-WOVEN-M076-48-X-Z	\$ 4.72 / \$ 5.98	\$ 11.09 / \$ 12.77	\$ 14.63 / \$ 16.32
4"	102	-64	T-S-WOVEN-M102-64-X-Z	\$ 6.05 / \$ 7.62	\$ 14.92 / \$ 17.07	\$ 19.52 / \$ 21.68

Same Price Plain or Drop Warp (known as LadderTape™ or Bolt-Hole Tape)

This Product is Available in Full Rolls Only – Please enquire for exceptions

Some tapes available in 50 foot lengths – please enquire. Add 25% to above pricing when ordering in 50 foot lengths. Some tapes available in by-the-foot cut lengths – please enquire. Add 50% to above pricing when ordering by-the-foot cut lengths.

- For the "X" value, specify: "A1" for 1/16" thick tape
"B2" for 1/8" thick tape
"C4" for 1/4" thick tape
- For "Z" value in part number: use "-P" for Plain style tape
or "-DW" for Drop Warp style tape.

Add "-PSA" to the part number to order tape with PSA on one side.

* Note: The PSA will burn off at temperatures above 400°F and should be used to facilitate installation. Material with PSA should not be used in confined areas at elevated temperatures without ventilation until all of the PSA has vaporized.

Silica Woven Gasket & Thermal Insulating Tape – Extreme High Temperature Heat Flame Molten Metal & Weld Splatter Resistant 1900°F / 1037°C: InSilMax™ XT



Available in Plain and Drop Warp (also known as Ladder Tape™ or Bolt-Hole Tape).

An alternative to asbestos and ceramic based textiles. Highly flexible and virtually no shrinkage. High abrasion resistance and tensile strength. Melts above 3000°F / 1648°C. Available with a PSA (pressure sensitive adhesive) to facilitate easy installation (*see note).

Woven tape has the benefit of edges that will not fray unless cut.

Produced from an extremely pure silica base yarn instead of leached yarn; providing extended temperature range and durability.

Common applications for this tape are as a gasket and seal material on high temperature access doors, inspection and clean-out doors and panels for kilns, ovens, furnaces, ventilation systems, etc.

InSilMax™ XT Extreme Temperature, Heat, Flame, Molten Metal & Weld Splatter Resistant Woven Silica Tapes						
Plain & Drop Warp Woven Silica Tape – 100 foot roll						
Available in 3 thicknesses: 1/16" / 2mm thick • 1/8" / 3.2mm thick • 1/4" / 6.4mm thick						
Width inch / mm / dash #			Part Number	1/16" / 2mm Price per foot no PSA / with PSA	1/8" / 3.2mm Price per foot no PSA / with PSA	1/4" / 6.4mm Price per foot no PSA / with PSA
1"	25	-16	T-S-XT-W-M025-16-X-Z	\$ 2.03 / \$ 2.15	\$ 4.62 / \$ 5.24	\$ 5.80 / \$ 6.40
1 1/2"	38	-24	T-S-XT-W-M038-24-X-Z	\$ 2.83 / \$ 3.48	\$ 6.48 / \$ 7.38	\$ 8.46 / \$ 9.36
2"	51	-32	T-S-XT-W-M051-32-X-Z	\$ 3.69 / \$ 4.49	\$ 8.58 / \$ 9.69	\$ 11.14 / \$ 12.26
3"	76	-48	T-S-XT-W-M076-48-X-Z	\$ 5.42 / \$ 6.88	\$ 12.75 / \$ 14.69	\$ 16.82 / \$ 18.76
4"	102	-64	T-S-XT-W-M102-64-X-Z	\$ 6.96 / \$ 8.76	\$ 17.16 / \$ 19.63	\$ 22.39 / \$ 24.93

Same Price Plain or Drop Warp (known as LadderTape™ or Bolt-Hole Tape)

This Product is Available in Full Rolls Only – Please enquire for exceptions

Some tapes available in 50 foot lengths – please enquire. Add 25% to above pricing when ordering in 50 foot lengths. Some tapes available in by-the-foot cut lengths – please enquire. Add 50% to above pricing when ordering by-the-foot cut lengths.

- For the "X" value, specify: "A1" for 1/16" thick tape
"B2" for 1/8" thick tape
"C4" for 1/4" thick tape
- For "Z" value in part number: use "-P" for Plain style tape
or "-DW" for Drop Warp style tape.

Add "-PSA" to the part number to order tape with PSA on one side.

* Note: The PSA will burn off at temperatures above 400°F and should be used to facilitate installation. Material with PSA should not be used in confined areas at elevated temperatures without ventilation until all of the PSA has vaporized.

Ceramic Fiber Gasket & Thermal Insulating Woven Tape 2000°F / 1093°C: CerMax™ Extreme High Temperature, Heat, Flame, Molten Metal & Weld Splatter Resistant



Available in Plain and Drop Warp style (also known as Ladder Tape™ or Bolt-Hole Tape).

Highly flexible and virtually no shrinkage. Melts above 3000°F / 1648°C.

Woven tape has the benefit of edges that will not fray unless cut.

Ceramic fiber tapes do not have the mechanical tensile strength of tapes made from other materials due to the short fiber lengths. To enhance the mechanical durability and handleability, these tapes are made with either Fiberglass or Inconel wire reinforcement.

Common applications for this tape are as a gasket and seal material on high temperature access doors, inspection and clean-out doors and panels for kilns, ovens, furnaces, ventilation systems, etc.

CerMax™ Extreme Temperature +Plus, Heat, Flame, Molten Metal & Weld Splatter Resistant Ceramic Fiber Tapes - 100 foot roll length					
Width inch / mm		Part Number	1/16" / 2mm thick Price per roll Fiberglass / Wire insert	1/8" / 3.2mm thick Price per roll Fiberglass / Wire insert	1/4" / 6.4mm thick Price per roll Fiberglass insert
1/2	13	T-C-WOVEN-0.500-M013-X-Y	\$ 28.75 / NA	\$ 35.65 / NA	NA
1"	25	T-C-WOVEN-1.000-M025-X-Y	\$ 43.70 / \$ 51.75	\$ 59.80 / \$ 66.70	NA
1 1/2"	38	T-C-WOVEN-1.500-M038-X-Y	NA / NA	\$ 88.55 / NA	NA
2"	51	T-C-WOVEN-2.000-M051-X-Y	\$ 78.20 / \$ 93.15	\$ 106.95 ** / \$ 124.20	\$ 210.00
2 1/2"	64	T-C-WOVEN-2.500-M064-X-Y	NA	NA / \$ 154.00	NA
3"	76	T-C-WOVEN-3.000-M076-X-Y	\$ 112.70 / \$ 117.30	\$ 154.10 ** / \$ 170.20	NA
4"	102	T-C-WOVEN-4.000-M102-X-Y	\$ 141.45 / \$ 149.50	\$ 193.20 ** / \$ 218.50	NA
6"	152	T-C-WOVEN-6.000-M152-X-Y	NA / NA	NA / \$331.20	NA

** Note: 1/8 thick; 2", 3" and 4" wide, fiberglass reinforced, is available in Plain or Drop Warp (also known as LadderTape™ or Bolt-Hole Tape). Same price either version.

Some tapes available in 50 foot lengths – please enquire. Add 25% to above pricing when ordering in 50 foot lengths. Some tapes available in by-the-foot cut lengths – please enquire.

- For the "X" value, specify: "A1" for 1/16" thick tape or "B2" for 1/8" thick tape
- For the "Y" value, specify: "F" for Fiberglass reinforced or "W" for wire reinforced
- Add "-DW" to specify Drop Warp style tape (Only in 2", 3" and 4" widths in 1/8" thick).

To aid in mounting this tape onto surfaces, FlangeStik™ pressure sensitive adhesive spray can be used to place the tape in situ temporarily. Permanent fasteners or grab strips should be installed prior to heating of the area sprayed above 200°F. The adhesive will “smoke-off” at elevated temperatures.

Note regarding the Inconel wire re-enforced tapes: Inconel alloys are oxidation- and corrosion-resistant materials well suited for service in extreme environments subjected to high pressure and kinetic energy. When heated, Inconel forms a thick and stable passivating oxide layer protecting the surface from further attack. Inconel retains strength over a wide temperature range, attractive for high-temperature applications where aluminum and steel would succumb to creep. **Caution:** Tapes with Inconel wire insert are electrically conductive.

CerMax Tape Technical Data

CerMax is alumino-silicate based refractory fiber. White and odorless. Available with either a fiberglass or wire re-inforcement. Some organic binder is present, and will smoke-off at elevated temperatures. Once the organics have smoked-off, the product will turn white again. If smoke free operation is required, then it should be heat treated before use.

Chemical & Physical Data: Total Al_2O_3 and $SiO_2 > 97\%$ (Al_2O_3 : 47%); $Fe_2O_3 < 1.1\%$. Weight Loss (1800°F) 8-10%; Refractory Fiber content $> 85\%$. Fiber diameter: 2 - 4 microns; Fiber length: 100 - 250 mm. Fiber shrinkage (1800°F, 3 hr) $< 3.5\%$

Thermal Conductivity: 570°F: 0.84 BTU/ft²°F/in (0.12 W/m °K). 1100°F: 0.91 BTU/ft²°F/in (0.13 W/m °K). 1800°F: 1.19 BTU/ft²°F/in (0.17 W/m °K).

Flexible Graphite Tape (Corrugated / Crinkled)
950°F / 510°C to 5400°F / 2982°C GraphTek™ Extreme High Temperature, Heat, Flame, Molten Metal & Weld Splatter Resistant



Flexible Graphite Tape is 99% Carbon, providing extreme heat protection, thermal dissipation, lubrication but does not add electrical conductivity. Made from mineral (flake) graphite it is non metallic, but thermally and electrically conductive just like metals.

Highly flexible and virtually no shrinkage. Melts above 6600°F / 3650°C.

This tape is corrugated / crinkled to aid in handling.

Service temperature range depends on surrounding conditions. Useable to 950°F / 510°C in an oxidizing atmosphere (standard air). Useable to 1500°F / 815°C in mild oxidizing or steam atmosphere and useable to 5400°F / 2982°C in non-oxidizing conditions.

Common applications for this tape are as an extreme temperature wrap for protection against flame and molten metal contact. Also used as gasket and seal material.

GraphTek™ Extreme Temperature +Plus, Heat, Flame, Molten Metal & Weld Splatter Resistant Graphite Tapes						
50 foot roll - .050" thick						
Width inch / mm / dash #			Part Number	Plain Tape	Plain Tape with PSA	Plain Tape with inhibitor
1/4	6	-04	T-GR-M006-04-X	\$ 5.86	\$ 9.74	NA
1/2"	13	-08	T-GR-M013-08-X	\$ 7.85	\$ 13.53	\$ 8.63
3/4"	19	-12	T-GR-M019-12-X	\$ 10.73	\$ 18.94	\$ 11.80
1"	25	-16	T-GR-M025-16-X	\$ 13.61	\$ 23.80	\$ 14.97
1 1/2"	39	-24	T-GR-M039-24-X	NA	\$ 29.84	NA

- For the "X" value, specify:
 "P" for plain tape.
 "PSA" for tape with PSA
 "IN" for tape with inhibitor



Heat Reflective Aluminum Foil Coated Fiberglass Tape:
Plain or with Pressure Sensitive Adhesive (PSA)
1000°F / 537°C: Peak with 650°F / 343°C

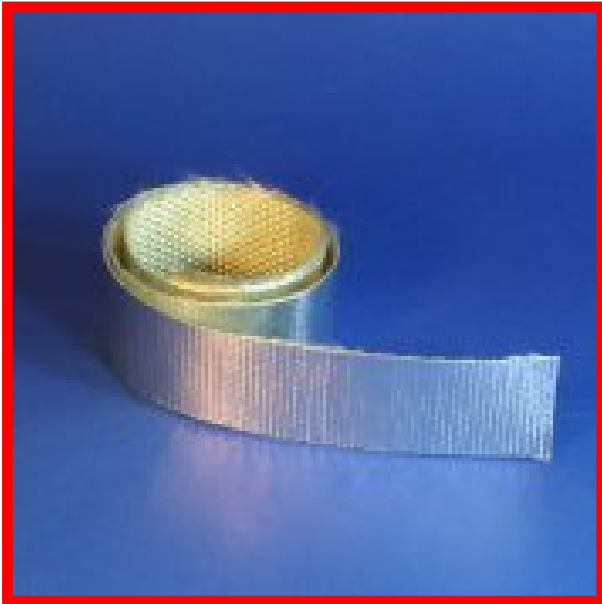

- Protection from intense radiant heat.
- Reflects more than 95% of the radiant heat that contacts its surface.
- Continuous operation at 650°F / 343°C.
- This tape is the perfect protection for cables and hoses when radiant heat from infrared sources such as super-hot metal slabs, proximity to liquid metal, open flame/plasma or engine exhaust manifolds is a concern.
- Can be supplied with self-adhesive (includes a backing paper).

Constructed from a high-temperature base fabric which is then coated with multiple layers of highly-reflective polished aluminum. Designed for long term continuous operation at 650°F / 343°C, this tape will withstand short duration exposure up to 1200°F / 650°C. The aluminum coating melts at 1220°F / 660°C, however it does take some time for the aluminum to absorb enough heat to melt – thereby it can withstand short exposure to the higher temperatures.

The tape is fabricated by slitting from a roll fabric.

The same base fabric can be used for constructing a wide variety of protective sleeves and covers for EAF (Electric Arc Furnace) Cable Covers, Festoon covers, robotic welding machine covers, etc.

Aluminized (Aluminum Foil Coated) Fiberglass Radiant Heat Reflective Tape		
Part Number	Width inch / mm	Price per Foot 21oz/yd² / 35oz/yd²
T-FG-AL-ST-M019-12-X	0.75 / 19	\$ 2.87 / \$ 3.44
T-FG-AL-ST-M025-16-X	1.00 / 25	\$ 3.55 / \$ 4.26
T-FG-AL-ST-M032-20-X	1.25 / 32	\$ 4.19 / \$ 5.03
T-FG-AL-ST-M038-24-X	1.50 / 38	\$ 4.87 / \$ 5.84
T-FG-AL-ST-M044-28-X	1.75 / 44	\$ 5.55 / \$ 6.67
T-FG-AL-ST-M051-32-X	2.00 / 51	\$ 6.21 / \$ 7.45
T-FG-AL-ST-M064-40-X	2.50 / 64	\$ 7.59 / \$ 9.11
T-FG-AL-ST-M076-48-X	3.00 / 76	\$ 8.91 / \$ 10.70
T-FG-AL-ST-M089-56-X	3.50 / 89	\$ 10.27 / \$ 12.33
T-FG-AL-ST-M102-64-X	4.00 / 102	\$ 11.58 / \$ 13.90
This tape can be fabricated in any width – please enquire		

For the X value: specify "21" for construction from 21 oz/yd² fabric; specify "35" for construction from 35 oz/yd² fabric



Stainless Steel Foil Coated Fiberglass Tape
1000°F / 537°C: High Temperature & Radiant Heat Reflective – Non Adhesive or with Pressure Sensitive Adhesive (PSA)

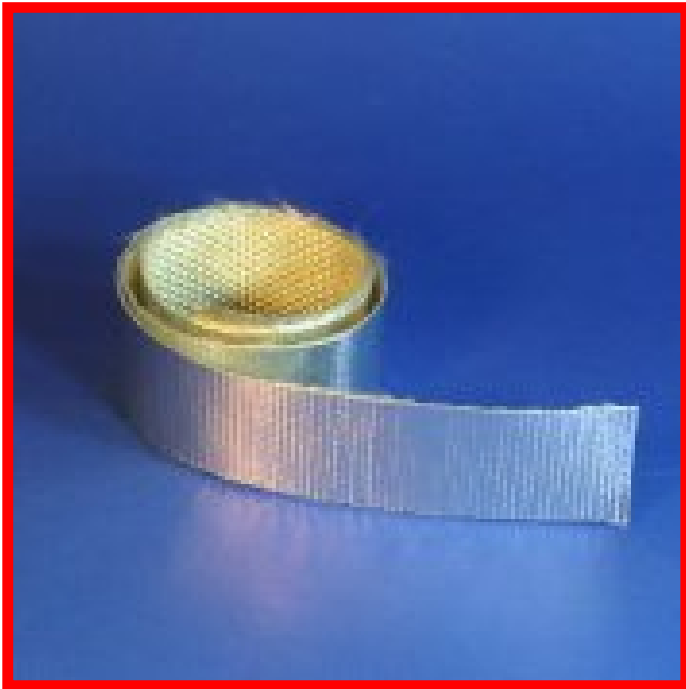

- Protection from intense radiant heat.
- Reflects more than 95% of the radiant heat that contacts its surface.
- Continuous operation at 650°F / 343°C.
- This tape is the perfect protection for cables and hoses when radiant heat from infrared sources such as super-hot metal slabs, proximity to liquid metal, open flame/plasma or engine exhaust manifolds is a concern.
- Can be supplied with self-adhesive (includes a backing paper).

Constructed from a high-temperature base fabric which is then coated with a layer of stainless steel foil. Designed for long term continuous operation at 650°F / 343°C, this tape will withstand short duration exposure up to 1200°F / 650°C. The aluminum coating melts at 1220°F / 660°C, however it does take some time for the aluminum to absorb enough heat to melt – thereby it can withstand short exposure to the higher temperatures.

The tape is slit from a roll fabric.

The same base fabric can be used for constructing a wide variety of protective sleeves and covers for wire & cable covers, Festoon covers, robotic welding machine covers, etc.

Stainless Steel Coated Fiberglass Radiant Heat Reflective Tape		
Part Number	Width inch / mm	Price / Foot
T-FG-SS-SLIT-M019-12-X	0.75 / 19	\$ 3.44
T-FG-SS-SLIT-M025-16-X	1.00 / 25	\$ 4.26
T-FG-SS-SLIT-M032-20-X	1.25 / 32	\$ 5.03
T-FG-SS-SLIT-M038-24-X	1.50 / 38	\$ 5.84
T-FG-SS-SLIT-M044-28-X	1.75 / 44	\$ 6.67
T-FG-SS-SLIT-M051-32-X	2.00 / 51	\$ 7.45
T-FG-SS-SLIT-M064-40-X	2.50 / 64	\$ 9.11
T-FG-SS-SLIT-M076-48-X	3.00 / 76	\$ 10.70
T-FG-SS-SLIT-M089-56-X	3.50 / 89	\$ 12.33
T-FG-SS-SLIT-M102-64-X	4.00 / 102	\$ 13.90
This tape can be fabricated in any width – please enquire		

- For the “X” value, specify: “P” for plain tape with no PSA, “PSA” for tape with PSA (call for pricing)



Aluminum Foil Tape with Acrylic Adhesive

1000°F / 537°C: High Temperature & Radiant Heat Reflective: Meets MIL-T-23397B Type II

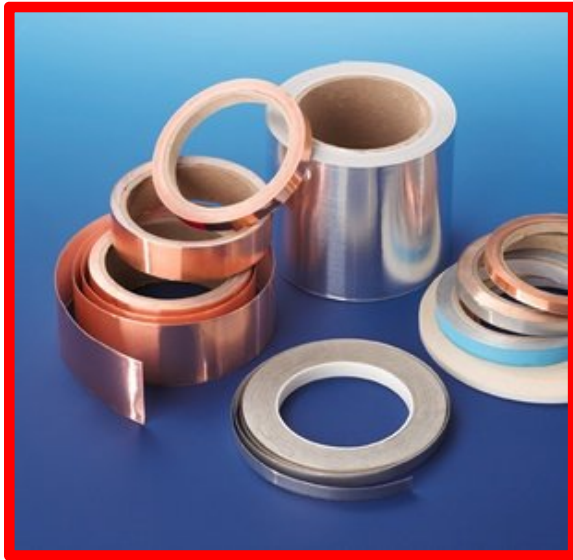

- Aluminum tape is an excellent reflector of radiant heat. Reflects more than 95% of the radiant heat that contacts its surface.
- Makes an excellent EMI/RFI shielding tape.
- Adheres and conforms to irregular surfaces.
- Provides a waterproofing/vapour and air barrier. Non-permeable.
- Heavy Duty .003" thickness foil with .002" thickness of adhesive.
- Roll length is 60 yards / 180 feet.
- Used as a masking tape for plating and painting applications.
- Aluminum foil melts at 1162°F / 627°C.
- Meets MIL-T-23397B, Type II

FlameShield™ High Temperature Aluminum Foil Tape with Acrylic Adhesive. MIL-T-23397B Type II			
Part Number	Tape Width		Price per Roll
	inch	mm	
T-AL-ACAD-M013-08	0.50	13	\$ 26.58
T-AL-ACAD-M019-12	0.75	19	\$ 39.85
T-AL-ACAD-M025-16	1.00	25	\$ 53.12
T-AL-ACAD-M051-32	2.00	51	\$ 106.25

The acrylic adhesive will smoke off at temperatures above 325°F/162°C

This tape is available in any width – please call for other sizes

Lead Foil Tape with Natural Rubber Adhesive
572°F / 300°C: High Temperature & Heat Resistant

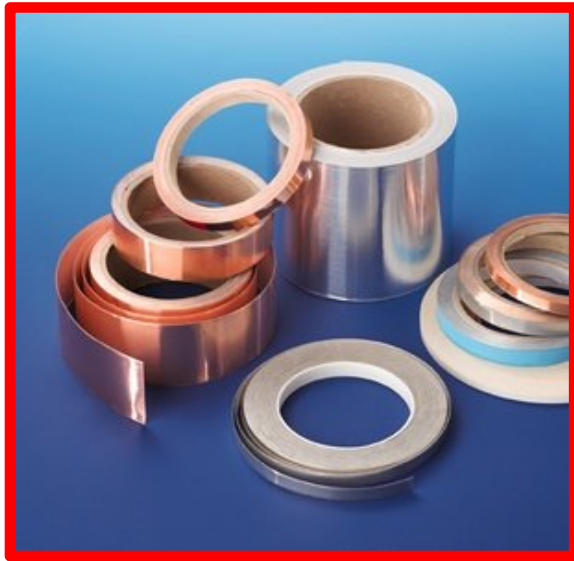

- Makes an excellent EMI/RFI shielding tape.
- Adheres and conforms to irregular surfaces.
- Provides a waterproofing/vapour and air barrier. Non-permeable.
- Heavy Duty .004” thickness foil with .0023” thickness of adhesive.
- Roll length is 36 yards / 108 feet.

FlameShield™ High Temperature Lead Foil Tape with Natural Rubber Adhesive			
Part Number	Tape Width inch / mm		Price per Roll
T-LD-NRAD-M013-08	0.50	13	\$ 118.03
T-LD-NRAD-M019-12	0.75	19	\$ 149.53
T-LD-NRAD-M025-16	1.00	25	\$ 186.90
T-LD-NRAD-M051-32	2.00	51	\$ 373.80

The rubber adhesive will smoke off at temperatures above 225°F/107°C

This tape is available in any width – please call for other sizes

GoldLook™ - Colored Aluminized PET Film With Acrylic Adhesive
572°F / 300°C: High Temperature & Heat Resistant



- Fiberglass Scrim base support fabric provides dimensional stability.
- Designed as a dress-up tape for automotive applications.
- Adheres and conforms to irregular surfaces.
- Provides a waterproofing/vapour and air barrier. Non-permeable.
- .006” total thickness.
- Roll length is 50 yards / 150 feet

FlameShield™ Gold Look PET Film Tape with Acrylic Adhesive			
Part Number	Tape Width inch / mm		Price per Roll
T-FG-CAL-M013-08	0.50	13	\$ 118.03
T-FG-CAL-M019-12	0.75	19	\$ 149.53
T-FG-CAL-M025-16	1.00	25	\$ 186.90
T-FG-CAL-M051-32	2.00	51	\$ 373.80

This tape is available in any width – please call for other sizes



Aluminum Foil Coated Heat Reflecting Fiberglass Tape; with adhesive 1000°F / 537°C: FlameShield™ High Temperature & Radiant Heat Reflective



- Protection from intense radiant heat. Reflects more than 95% of the radiant heat that contacts its surface.
- Base fabric rated for continuous operation at 1000°F / 537°C.
- This tape has a high temperature adhesive across its entire width, allowing the tape to be wrapped and formed into a sleeve around wires, cables or hoses. Can also be applied to other objects and shapes and used flat.
- Provides protection for cables and hoses when radiant heat from infrared sources such as super-hot metal slabs, proximity to liquid metal, open flame/plasma or engine exhaust manifolds is a concern.
- Thickness of .025".

This high temperature and radiant heat reflective tape is constructed from a high-temperature fine woven fiberglass fabric substrate, which is then coated with highly-reflective polished aluminum. The base fabric is designed for long term continuous operation at 1000°F / 537°C, this sleeve will withstand short duration exposure up to 1200°F / 650°C. The non aluminum side of the fabric is coated with an adhesive.

Added protection can be achieved by layering with other sleeve or tape materials underneath the reflective layer.

FlameShield™ Aluminum Foil Coated Fiberglass Radiant Heat Reflective Tape with Pressure Sensitive Adhesive			
Part Number	Width inch / mm / dash	Spool Length, feet Bulk / Small	Price per Foot Bulk Spool / Small Spool
T-FG-AL-STA-M025-16-X	1.00 / 25 / -16	200 / 100	\$ 2.00 / \$ 2.17
T-FG-AL-STA-M038-24-X	1.50 / 38 / -24	200 / 100	\$ 3.10 / \$ 3.26
T-FG-AL-STA-M051-32-X	2.00 / 51 / -32	200 / 100	\$ 3.82 / \$ 3.97
T-FG-AL-STA-M076-48-X	3.00 / 76 / -48	200 / 100	\$ 5.72 / \$ 5.98
T-FG-AL-STA-M102-64-X	4.00 / 102 / -64	200 / 100	\$ 7.57 / \$ 7.74
T-FG-AL-STA-M127-80-X	5.00 / 127 / -80	200 / 100	\$ 9.42 / \$ 9.57
T-FG-AL-STA-M152-96-X	6.00 / 152 / -96	100 / 50	\$ 11.33 / \$ 11.67
T-FG-AL-STA-M178-112-X	6.875 / 175 / -103	100 / 50	\$ 13.20 / \$ 13.53

For the "X" value: use "B" for Bulk Spool size, use "S" for Small Spool size

This Product is Available in Spool Length Only



Weld Backing Tape

1000°F / 537°C: FlameShield™ Easily provides gas tight weld backing purge area and bead consistency

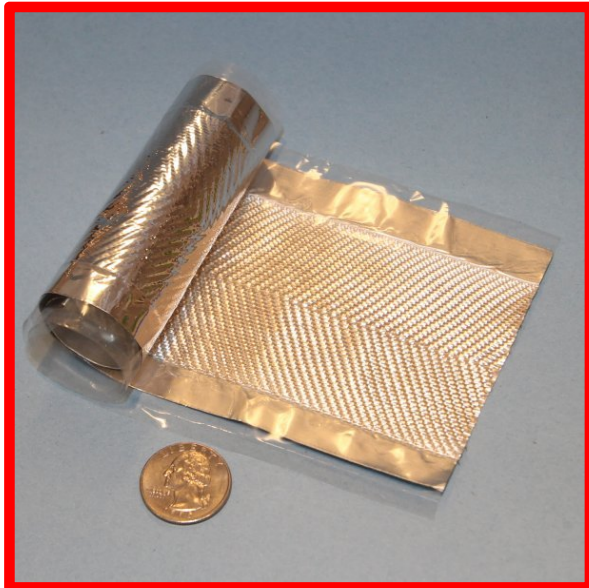

- Typically for welding thin wall stainless steel from one side. Attaches to the backside of the weld area and supports the weld pool, keeps the argon gas surrounding the weld pool.
- Eliminates the need to back-purge.
- Provides a consistent high quality under bead profile.
- The most popular tape is 3" wide with a 1" wide woven DeltaGlass tape strip in the middle.
- Supports single pass welding at currents up to 240 amps without change to the chemistry or metallurgy of the weld.
- Available in Light Duty (80 amp), Medium Duty (160 amp) and Heavy Duty (240 amp) ratings.

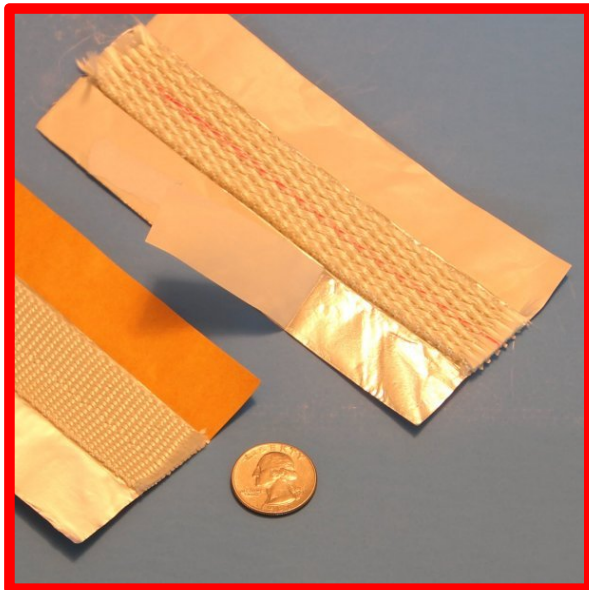

FlameShield™ Weld Backing Tape					
Part Number	Recommended Amp Max	Center Insulation Thickness	Tape Width	Tape Length, feet	Price
T-FG-AL-WELD-80	80	1/32	3.0"	40	\$ 182.75
T-FG-AL-WELD-160	160	1/16	3.0"	40	\$ 197.57
T-FG-AL-WELD-240	240	1/8	3.0"	40	\$ 217.48

Insulated Wrap Tape - For Pipe / Hose / Cable Protection & Thermal Insulation - High Temperature

500°F / 260°C: InsulSave™ Easy to use pipe wrap for steam and process piping/hoses – hot or cold protection and energy savings.

Useable from -67°F (-55°C) to +500°F (260°C)

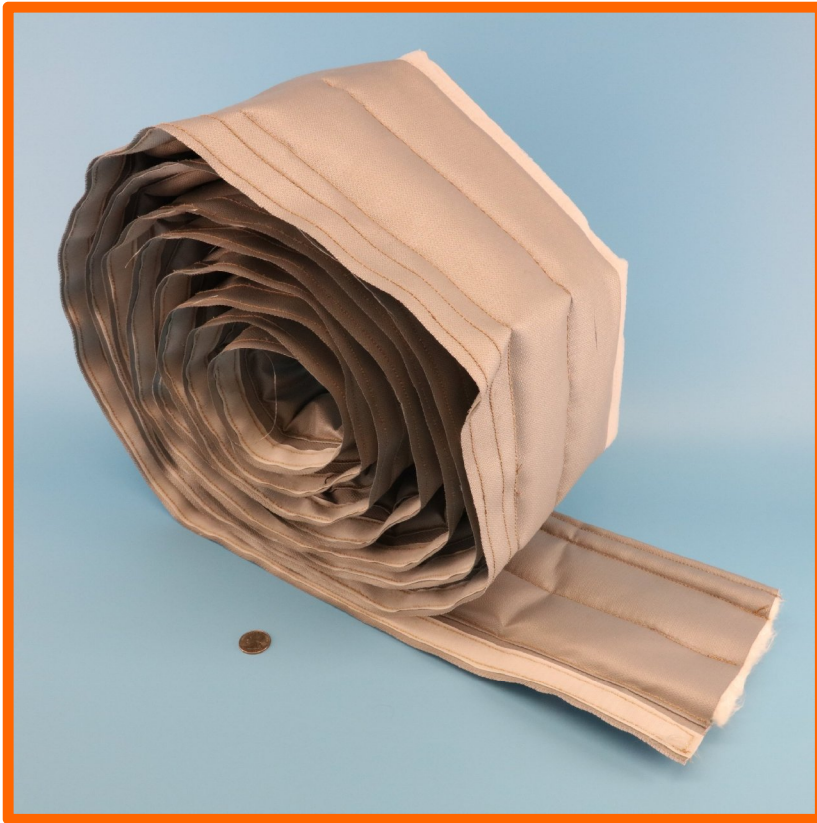

- Typically used to protect short indoor lengths of hot or cold piping and hoses. Excellent for steam pipes.
- Provides personnel protection and energy savings.
- Easy hook and loop closure works in either covering mode: longitudinal or spiral.
- Can be used longitudinally or spirally.
- "Lined" version has a PTFE coated fiberglass support fabric on the inside, protecting the insulation layer. Prevents the insulation fibers from damage.
- Available with 1/4", 1/2" or 3/4" thick insulation layer.
- Excellent for covering pipes with heater tapes installed.
- Excellent for labs as one width of wrap can insulate a variety of pipe or tube sizes when used in spiral mode.
- Can be used on large size pipes when spiral wrapped.
- Insulation layer meets MIL-I-24244. Outer silicone coated fabric meets UL214 and NFPA -701 and is available meeting MIL-I-24244 and NRC 1.36.

This photo shows the wrap with the liner installed



The wrap may be used longitudinally, or spiral wrapped. In these photos, the wrap has no liner installed

Insulated Wrap Tape - For Pipe / Hose / Cable Protection & (Continued)

Thermal Insulation - High Temperature

500°F / 260°C: InsulSave™ Easy to use pipe wrap for steam and process piping/hoses – hot or cold protection and energy savings.

Useable from -67°F (-55°C) to +500°F (260°C)



InsulSave™ Insulated Pipe Wrap Tape - Roll Length 20 feet with Nylon hook and loop closure. Nomex hook & loop add \$375.00. Stainless Steel hook and loop add \$720.00.				
Part Number	Pipe Size OD when used lengthwise	1/4" Insulation no liner / liner "X" = 4	1/2" insulation no liner / liner "X" = 8	3/4" insulation no liner / liner "X" = 12
FAB-T-FG-INSAVE-25-X-Y	¼" / 0.54"	\$ 176.12 / N/A	\$ 212.43 / N/A	N/A
FAB-T-FG-INSAVE-50-X-Y	½" / 0.84"	\$ 200.34 / \$ 262.92	\$ 232.77 / \$ 325.64	\$ 323.21 / \$ 506.31
FAB-T-FG-INSAVE-75-X-Y	¾" / 1"	\$ 215.67 / \$ 292.85	\$ 251.68 / \$ 351.14	\$ 343.56 / \$ 537.67
FAB-T-FG-INSAVE-100-X-Y	1" / 1.31"	\$ 245.63 / \$ 336.76	\$ 280.13 / \$ 397.43	\$ 392.45 / \$ 614.47
FAB-T-FG-INSAVE-150-X-Y	1 ½" / 1.9"	\$ 286.21 / \$ 396.83	\$ 319.24 / \$ 452.63	\$ 441.04 / \$ 674.58
FAB-T-FG-INSAVE-200-X-Y	2" / 2.375"	\$ 323.47 / \$ 444.81	\$ 361.07 / \$ 517.28	\$ 490.33 / \$ 780.43
FAB-T-FG-INSAVE-250-X-Y	2 ½" / 2.87"	\$ 354.75 / \$ 511.17	\$ 400.51 / \$ 573.58	\$ 531.47 / \$ 836.81
FAB-T-FG-INSAVE-300-X-Y	3" / 3.5"	\$ 411.07 / \$ 574.33	\$ 454.53 / \$ 654.73	\$ 597.58 / \$ 900.27
FAB-T-FG-INSAVE-350-X-Y	3 ½" / 4"	\$ 432.32 / \$ 632.66	\$ 479.63 / \$ 688.54	\$ 640.74 / \$ 1054.82
FAB-T-FG-INSAVE-400-X-Y	4" / 4.5"	\$ 481.47 / \$ 699.54	\$ 543.29 / \$ 771.28	\$ 703.88 / \$ 1130.66

This product will reduce the surface temperature of the wrap to a level which depends on the temperature of the inner pipe or hose and the thickness of the insulation layer. For thinner insulation layers, the surface temperature will be higher than for thicker layers. The standard nylon hook and loop closure can be used for surface temperatures up to 225°F continuous (300°F for 1 hour – melts at 450°F). For higher temperatures a nomex hook and loop closure can be used which can be used up to 350°F continuous. For temperatures between 350°F and 500°F a stainless steel hook and loop is available or the wrap can be used without hook and loop closure and instead use our free-end stainless steel cable ties to secure it. To approximately determine the surface temperature please see the next page in the catalog.

This is a fabricated item: please allow 5 days for production

For the "X" value, use:

"4" for 1/4" insulation; "8" for 1/2" insulation; "12" for 3/4" insulation

For the "Y" value, use: "NL" for No Liner; "WL" for With Liner

Insulated Wrap Tape Thermal Profile Information (Continued)

500°F / 260°C: InsulSave™ Easy to use pipe wrap for steam and process piping/hoses – hot or cold protection and energy savings.

Useable from -67°F (-55°C) to +500°F (260°C)

Determining if the wrap tape can be used to protect personnel from hot pipe burns

Under OSHA requirements, there is no specific temperature that a pipe or hose or other hot item must be at or below to consider it safe for contact. The OSHA regulations state that steam and hot water pipes shall be covered with insulation or be guarded.

It has generally been accepted by workplace health and safety professionals that metallic items that are above 140°F / 60°C should be protected in a manner so that accidental contact will not produce a burn. Therefore, a target temperature of 140°F / 60°C and below is desirable for metallic objects. Therefore one can also think that any insulation system on a hot pipe or hose should therefore also have a maximum surface temperature of 140°F / 60°C.

There is a standard, UL2200, which does provide some specific temperature numbers for use with engine driven generators, and of interest they differentiate metallic from non-metallic items. It is important to remember that metals conduct heat, and most thermal protection systems (insulation, fabrics, tapes, etc.), do not. This means that the insulation system surface can be “hotter” than a metal surface and still be “touch safe”.

So the maximum temperature that the surface of an insulation system can be at should be below 203°F / 95°C for accidental or casual brush-by contact.

Location	Composition of surface ^a	
	Metal	Nonmetallic
Handles or knobs that are grasped for holding	50• C (122• F)	60• C (140• F)
Handles or knobs that are contacted and do not involve holding; and other surfaces subject to contact and user maintenance	60• C (140• F)	85• C (185• F)
Surfaces subject to casual contact ^a	70• C (158• F)	95• C (203• F)

^a A handle, knob, or similar device, made of a material other than metal that is plated or clad with metal having a thickness of 0.005 inch (0.127 mm) or less is judged as a nonmetallic part.

^b See the Exception to 38.3.

UL2200 temperature limits

The information on the next page provides more information to help determine what thickness of insulation may result in a pipe wrap that will provide the desired temperature drop from the surface of the pipe to the surface of the pipe wrap.

It can be seen that the ½” thick insulation can provide, for example, a suitable drop for pipes operating up to 500°F and that the standard nylon hook and loop is suitable at the surface temperature of 203°F.

Thinner ¼” insulation would provide less of a temperature differential while the ¾ “ insulation would provide more differential. This information should only be used as a guideline and every installation will be different. The information presented should help you to determine if you are on the correct path to determining the best solution to meet your needs.

Insulated Wrap Tape Thermal Profile Information (Continued)

500°F / 260°C: InsuSave™ Easy to use pipe wrap for steam and process piping/hoses – hot or cold protection and energy savings.

Useable from -67°F (-55°C) to +500°F (260°C)

Insulation Properties of the Insulated Wrap Tape

Physical Properties		Properties of Fiberglass "E" Glass		
Service Temperature.....	Up to 1200°F	Physical/Mechanical Properties of Glass Fibers		
Fire Resistance.....	Incombustible	Specific Gravity.....	2.60 grams/cc.	
Density (Approximate).....	9 lbs./cu. ft.	Density.....	0.094 lbs./cu. in.	
Moisture Absorption.....	Negligible	Tensile Strength (PSI)x10 ³ @ 72°F.....	500 lbs.	
Thermal Conductivity ("K" value at 9.1 lbs./cu. ft.):		Modulus of Elasticity (PSI)x10 @ 72°F.....	10.5 lbs.	
Mean Temperature	"K"-btu/sq. ft./hr./°F/in.	After Heating (PSI)x10 @ 1000°F.....	11.8 lbs.	
300°F	0.40	Elongation @ 72°F.....	4.8%	
500°F	0.50	Thermal Properties of Bulk Glass		
700°F	0.65	Softening Point.....	1500°F	
Thermal Conductivity (btu/sq ft/hr/°F/in)		Strain Point.....	1100°F	
		Annealing Point.....	1200°F	
Glass Filament Tensiles (at various temperatures)		Electrical Properties of Bulk Glass		
		Dielectric Constant		
		1 MHz @ 72°F.....		6.33
		10kHz @ 72°F.....		6.13
		Power Factor		
		1MHz @ 72°F.....		0.001
		10kHz @ 72°F.....		0.0039

Note: The physical and performance properties cited in this literature have been derived in tests conducted by various fiber companies. Tests have been conducted on both fiber and fabrics woven with bulked glass fiber. Reference to U.S. Government specification values as well as information provided on certain end uses which currently use bulked glass are presented for the information of potential customers in determining the potential suitability of these products for their own applications. No claims are made as to the accuracy or applicability of the test methods employed or the results derived therefrom.

Important Cautionary Note: Items of protective equipment manufactured from fiberglass fabrics such as aprons, gloves, mittens, etc. should be labeled to show the maximum short-term and continuous-exposure temperature limits established in accordance with the standard specifications applicable to the item of equipment being offered.

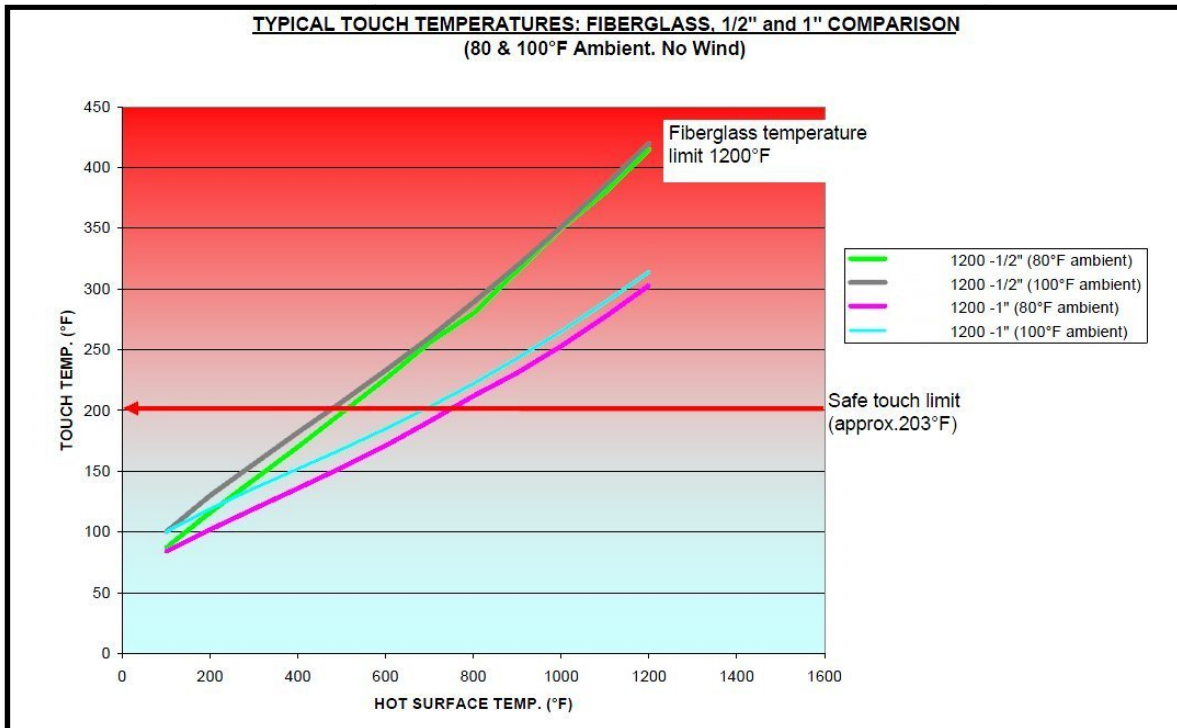

FlangeStik™ Pressure Sensitive Adhesive Spray for Tape Mounting



- Covers approximately 90 to 100 square feet. (enough for mounting a quantity of five 2" wide x 100 foot tapes for example)
- Used for temporary mounting of tapes onto flanges, gasket channels or contact areas while permanent hardware is installed.
- Available in butyl rubber adhesive or silicone adhesive.
- Greatly assists in the installation of tapes and fabrics onto metal and non-metal surfaces.
- 340g (12oz) net contents.
- Ships ground only.

FlangeStik™ Pressure Sensitive Adhesive Spray for Tape and Fabric Mounting

Part Number	Adhesive	Price
AD-PSA-BR-340-12	Butyl rubber	26.64
AD-PSA-US-340-12	Silicone	Call



FlangeStik™ Pressure Sensitive Adhesive Mounting Tape

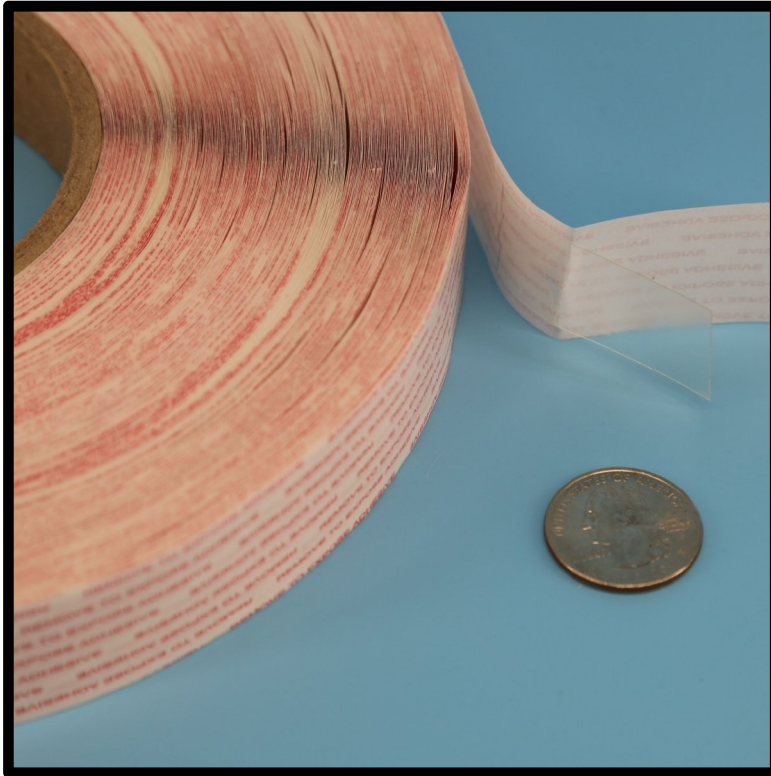

- 1" wide backing paper with 0.75" wide adhesive mounting tape PSA layer.
- Backing paper is white, PSA film is transparent.
- Adhesive is hot melt rubber based.
- Used for temporary mounting of tapes onto flanges, gasket channels or contact areas while permanent hardware is installed.
- Greatly assists in the installation of tapes and fabrics onto metal and non-metal surfaces.
- Roll length is 1600 feet.
- Total thickness is 0.0059". Liner is 0.0028" thick. Adhesive film is 0.0031" thick
- Service temperature is 32°F to 158°F. Should be applied at 50°F to 122°F.

FlangeStik™ Pressure Sensitive Mounting Tape		
Part Number	Adhesive	Price
T-AD-PSA-TAPE	Butyl rubber	\$ 276.47

TadpoleTape™

500°F / 260°C Silicone Rubber TadpoleTape™	2-101
500°F / 260°C Silicone Rubber Coated Stainless Mesh TadpoleTape™	2-101
320°F / 160°C Aramid High Strength TadpoleTape™	2-102
1200°F / 648°C Precision Fiberglass TadpoleTape™	2-103
1200°F / 648°C Fiberglass Heavy Duty TadpoleTape™: with Rope or Wire Mesh Core	2-104
1350°F / 732°C ProSil™ Silica/Glass Blended Fabric Heavy Duty TadpoleTape™: with Rope or Wire Mesh Core	2-105
1350°F / 732°C ProSilMax™ Silica/Glass Blended Fabric with wire insert Heavy Duty TadpoleTape™: with Rope or Wire Mesh Core	2-106
1500°F / 815°C Fiberglass with Vermiculite Coating Heavy Duty TadpoleTape™: with Rope or Wire Mesh Core	2-107
1800°F / 982°C InSilMax™ Heavy Duty TadpoleTape™: with Rope or Wire Mesh Core	2-108
1900°F / 1037°C InSilMax™ XT Heavy Duty TadpoleTape™: with Rope or Wire Mesh Core	2-108
2000°F / 1093°C CerMax™ Heavy Duty TadpoleTape™: with Rope or Wire Mesh Core	2-110

Tadpoles with Specialized Coatings

550°F / 287°C Fiberglass with PTFE Coating Heavy Duty TadpoleTape™: with Rope or Wire Mesh Core	2-112
550°F / 287°C Rubberized Fiberglass Tacky Cloth Heavy Duty TadpoleTape™: with Rope or Wire Mesh Core	2-113
550°F / 287°C Expanded PTFE Heavy Duty TadpoleTape™: with Rope or Wire Mesh Core	2-114

CUSTOM SIZED TADPOLE GASKET TAPE

The catalogue pages for tadpole gasket tapes show our line of standard materials and sizes that are made by our fabrication shop.

Our tadpole gasket fabrication shop can manufacture tadpoles of almost size and shape using our standard materials, or from other materials not normally used.

Please feel free to request a quote; either a description, or a drawing, or a photo is useful. If you would like us to match materials to an existing tadpole that needs replacement, then either a detailed close-up photo or a sample would be very useful.

Please send quote requests to info@abthermal.com or call the order desk at 610-906-3549.

High Temperature Silicone Rubber “P” and Tadpole Gasket Seals 500°F / 260°C



Extruded “P” Tadpole Gasket Seal

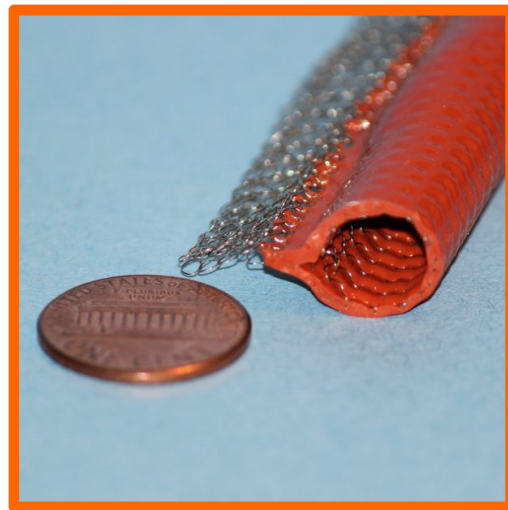

Stainless Mesh with Silicone Rubber Bulb

Silicone rubber extruded profiles make excellent gaskets and seals. Can be used for applications up to 500°F / 260°C continuous rating with weld splatter / molten metal splash protection. These silicone rubber products provide excellent cold temperature performance with flexibility to -76°C for refrigeration and cryogenic applications.

Excellent sealing against liquids and gases.

TT-SS-SR-0.937-0.437 is a 15/16” overall width tadpole with a 7/16” OD bulb. It is a common tadpole to use in cryogenic freezing access doors, such as food processing freezing and packaging lines.

High Temperature & Heat Resistant Silicone Rubber Tadpole Gasket Tape			
Part Number	Feet / Metres per Spool	Price per spool	Price per foot
TT-SR-M051-32-E	100 / 30.48	\$ 1491.66	NA
TT-SS-SR-0.937W-0.437B	100 / 30.48	\$ 670.00	\$ 15.41

OTHER SIZES AVAILABLE – PLEASE INQUIRE

Custom sized tadpole gasket tapes are available – Please provide dimensions or a drawing



Aramid (Aromatic Polyamide) Tadpole Tape with Aramid Rope or Wire Mesh Bulb Core

320°F / 160°C TadpoleTape™ High Temperature, Heat Resistant & High Strength

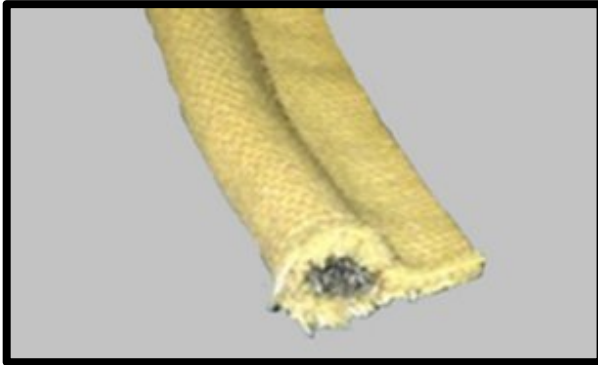

Made from our aramid fabrics and ropes, and metallic mesh ropes, this is a soft and resilient gasket material for effective sealing on light metal flanges and where limited bolting force is available – and where doors and other closures rest on the bulb. The aramid fabric is very abrasion and cut resistant, ideal for high cycle applications. Not suitable for applications involving prolonged sunlight or UV exposure.

Available By-The-Foot or in standard rolls of 50 and 100 feet. **This product has a \$250 minimum order value.**

Kevlar® is a popular brand name of an Aramid polyamide material from DuPont. Our Aramid is not a DuPont product.

This product is highly flexible and conformable.

TadpoleTape™ High Temperature & Heat Resistant Aramid with Aramid Rope Core

Part Number	Over All Width in / mm	Price per Foot By Bulb Size: A / B / C / D / E in / mm				
		"A"	"B"	"C"	"D"	"E"
		3/8" / .375 / 7.9	1/2" / .500 / 13	5/8" / .625 / 15.8	3/4" / .750 / 19	1" / 1.000 / 25
TT-A-RC-M025-16-X	1.00 / 25	\$ 8.40	\$ 9.24	\$ N/A	N/A	N/A
TT-A-RC-M032-20-X	1.25 / 32	\$ 8.64	\$ 9.60	\$ 11.04	\$ 11.66	N/A
TT-A-RC-M038-24-X	1.50 / 38	\$ 9.24	\$ 9.96	\$ 11.40	\$ 12.50	N/A
TT-A-RC-M044-28-X	1.75 / 44	\$ 9.60	\$ 10.32	\$ 12.00	\$ 13.08	\$ 18.64
TT-A-RC-M051-32-X	2.00 / 51	\$ 9.72	\$ 11.04	\$ 12.84	\$ 13.44	\$ 19.32
TT-A-RC-M063-40-X	2.50 / 63	\$ 10.92	\$ 11.88	\$ 13.92	\$ 14.40	\$ 20.40
TT-A-RC-M076-48-X	3.00 / 76	\$ 11.88	\$ 12.72	\$ 14.34	\$ 15.48	\$ 21.12

TadpoleTape™ High Temperature & Heat Resistant Aramid with Stainless Steel or Inconel 600 Mesh Core

Part Number	Over All Width in / mm	Price per Foot By Bulb Size: A / B / C / D / E in / mm				
		"A"	"B"	"C"	"D"	"E"
		3/8" / .375 / 7.9 SS / Inconel	1/2" / .500 / 13 SS / Inconel	5/8" / .625 / 15.8 SS / Inconel	3/4" / .750 / 19 SS / Inconel	1" / 1.000 / 25 SS / Inconel
TT-A-MC-M025-16-X-Z	1.00 / 25	\$11.68 / \$14.16	\$12.48 / \$16.40	N/A	N/A	N/A
TT-A-MC-M032-20-X-Z	1.25 / 32	\$11.84 / \$14.32	\$12.64 / \$16.64	\$16.96 / \$18.08	\$16.12 / \$19.12	NA
TT-A-MC-M038-24-X-Z	1.50 / 38	\$12.08 / \$14.40	\$12.88 / \$16.96	\$17.12 / \$18.32	\$16.56 / \$19.60	NA
TT-A-MC-M044-28-X-Z	1.75 / 44	\$12.40 / \$14.96	\$13.12 / \$17.28	\$17.52 / \$18.64	\$17.68 / \$20.40	\$20.64 / \$22.28
TT-A-MC-M051-32-X-Z	2.00 / 51	\$12.56 / \$15.44	\$13.52 / \$17.76	\$18.08 / \$19.20	\$18.30 / \$21.56	\$21.55 / \$23.48
TT-A-MC-M063-40-X-Z	2.50 / 63	\$13.20 / \$16.16	\$13.92 / \$18.40	\$18.80 / \$19.76	\$19.76 / \$22.92	\$22.72 / \$24.80
TT-A-MC-M076-48-X-Z	3.00 / 76	\$13.76 / \$16.72	\$14.48 / \$19.60	\$19.68 / \$20.96	\$21.23 / \$23.64	\$23.80 / \$25.40

For the "X" value: specify either A, B, C, D, or E
 For the "Z" value: specify "S" for Stainless Steel or "I" for Inconel

OTHER CUSTOM SIZES & SHAPES AVAILABLE – PLEASE INQUIRE



Precision Fiberglass Tadpole Gasket Tape
Oven / Boiler / Kiln / Paint Booth / Clean Room Door Seals
1200°F / 648°C TadpoleTape™ Very High Temperature & Heat Resistant

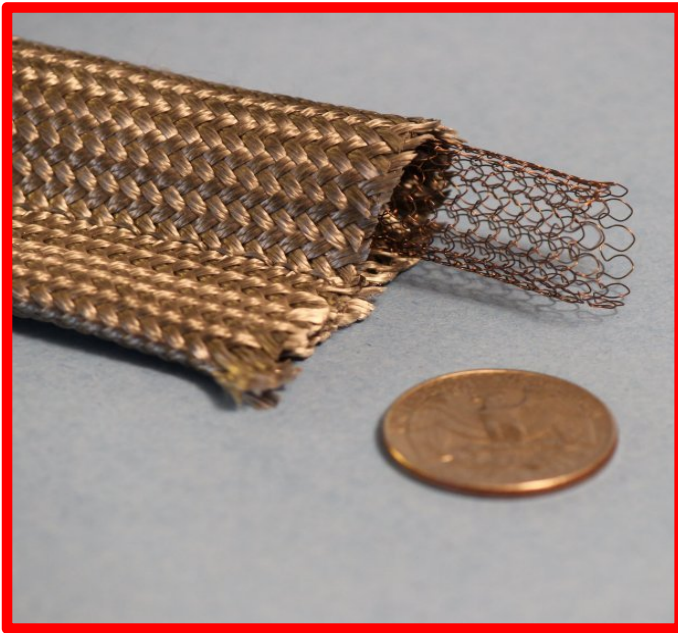

- Precision Tadpole with consistent dimension of bulb and tail.
- Small tail is hollow, and can be supplied filled with a cord or rope to use as a mounting point with slotted metalwork.
- High pushback 304 stainless steel hollow sleeve inside of bulb provides excellent pushback with low compression set.
- Heat treated to result in an extremely clean surface that sheds extremely few fibers and no organic odors. Suitable for paint booth and food service applications.
- Fabricated from high quality type E fiberglass that will not burn and will withstand continuous exposure to temperatures of 1200°F / 648°C.
- This product resists most acids and alkalis and is unaffected by most bleaches and solvents. It is highly flexible and conformable. The base fiber is manufactured to the specifications of ASTM D-578, ASTM committee D13, and subcommittee D13.18.

- Two sizes available:
- 1) 1 3/8 inch OAW (Over All Width) with a 5/8" Bulb with hollow 304 stainless steel mesh core bulb material, with 3/4" tail. The knitted wire mesh core provides excellent compression and pushback and high cycle life. ID of the hollow metal mesh bulb core is 1/2 inch.
 - 2) 1 1/4 inch OAW (Over All Width) with a 1/2" Bulb with hollow 304 stainless steel mesh core bulb material, with 3/4" tail. The knitted wire mesh core provides excellent compression and pushback and high cycle life. ID of the hollow metal mesh bulb core is 7/16 inch.

Very High Temperature & Heat Resistant Heat Treated Fiberglass Precision Tadpole Gasket Tape with Hollow Stainless Steel Knit Mesh Core			
Part Number	Bulb Size	Feet / Metres per coil	Price per coil / foot
TT-FG-HMC-M013-08-25-X	1/2"	25 / 7.6	\$ 173.25 per coil
TT-FG HMC-M013-08-50-X	1/2"	50 / 15.2	\$ 346.50 per coil
TT-FG HMC-M013-08-250-X	1/2"	250 / 76.2	\$ 1218.64 per coil
TT-FG HMC-M013-08-BTF-X	1/2"	By The Foot	\$ 10.40 / foot
TT-FG-HMC-M016-10-25-X	5/8"	25 / 7.6	\$ 198.66 per coil
TT-FG HMC-M016-10-50-X	5/8"	50 / 15.2	\$ 361.73 per coil
TT-FG HMC-M016-10-250-X	5/8"	250 / 76.2	\$ 1455.62 per coil
TT-FG HMC-M016-10-BTF-X	5/8"	By The Foot	\$ 12.38 / foot

Genuine TadpoleTape™ gasket is designed to provide a high temperature thermal seal in industrial, laboratory and commercial ovens and dryers. Used on residential self cleaning ovens as a door gasket seal.

Custom sized tadpole gasket tapes are available



Fiberglass Tadpole Tape with Fiberglass Rope or Wire Mesh Bulb Core 1200°F / 648°C TadpoleTape™ Very High Temperature & Heat Resistant



Made from our heavy duty fiberglass fabrics and ropes, and metallic mesh ropes, this is a soft and resilient gasket material for effective sealing on light metal flanges and where limited bolting force is available – and where doors and other closures rest on the bulb.

Standard Rolls of 50 and 100 feet. For By-The-Foot pricing add 25% to price shown. **This product has a \$25 minimum order value.**

A Heat Treated version of this product is available for clean room door sealing – please enquire

Fabricated from high quality type E fiberglass that will not burn and will withstand continuous exposure to temperatures of 1200°F / 648°C. This product resists most acids and alkalis and is unaffected by most bleaches and solvents. It is highly flexible and conformable.

TadpoleTape™ Very High Temperature & Heat Resistant Fiberglass with Rope Core

Part Number	Over All Width in / mm	Price per Foot By Bulb Size: A / B / C / D / E in / mm				
		"A"	"B"	"C"	"D"	"E"
		3/8" / .375 / 7.9	1/2" / .500 / 13	5/8" / .625 / 15.8	3/4" / .750 / 19	1" / 1.000 / 25
TT-FG-RC-M025-16-X	1.00 / 25	\$ 2.80	\$ 3.08	\$ 3.48	NA	NA
TT-FG-RC-M032-20-X	1.25 / 32	\$ 2.88	\$ 3.20	\$ 3.68	NA	NA
TT-FG-RC-M038-24-X	1.50 / 38	\$ 3.08	\$ 3.32	\$ 3.80	\$ 4.20	NA
TT-FG-RC-M044-28-X	1.75 / 44	\$ 3.20	\$ 3.44	\$ 4.00	\$ 4.36	\$ 6.88
TT-FG-RC-M051-32-X	2.00 / 51	\$ 3.24	\$ 3.68	\$ 4.28	\$ 4.48	\$ 6.44
TT-FG-RC-M063-40-X	2.50 / 63	\$ 3.64	\$ 3.96	\$ 4.68	\$ 4.80	\$ 6.80
TT-FG-RC-M076-48-X	3.00 / 76	\$ 3.96	\$ 4.24	\$ 4.64	\$ 5.16	\$ 7.04

TadpoleTape™ Very High Temperature & Heat Resistant Fiberglass with Stainless Steel or Inconel 600 Mesh Core

Part Number	Over All Width in / mm	Price per Foot By Bulb Size: A / B / C / D / E in / mm				
		"A"	"B"	"C"	"D"	"E"
		3/8" / .375 / 7.9 SS / Inconel	1/2" / .500 / 13 SS / Inconel	5/8" / .625 / 15.8 SS / Inconel	3/4" / .750 / 19 SS / Inconel	1" / 1.000 / 25 SS / Inconel
TT-FG-MC-M025-16-X-Z	1.00 / 25	\$5.84 / \$7.08	\$6.24 / \$8.20	\$8.32 / NA	NA	NA
TT-FG-MC-M032-20-X-Z	1.25 / 32	\$5.92 / \$7.16	\$6.32 / \$8.32	\$8.48 / \$9.04	NA	NA
TT-FG-MC-M038-24-X-Z	1.50 / 38	\$6.04 / \$7.20	\$6.44 / \$8.48	\$8.56 / \$9.16	\$12.56 / \$18.20	NA
TT-FG-MC-M044-28-X-Z	1.75 / 44	\$6.20 / \$7.48	\$6.56 / \$8.64	\$8.76 / \$9.32	\$12.68 / \$18.40	\$20.64 / \$22.28
TT-FG-MC-M051-32-X-Z	2.00 / 51	\$6.28 / \$7.72	\$6.76 / \$8.88	\$9.04 / \$9.60	\$12.80 / \$18.56	\$20.64 / \$22.48
TT-FG-MC-M063-40-X-Z	2.50 / 63	\$6.60 / \$8.08	\$6.96 / \$9.20	\$9.40 / \$9.88	\$13.20 / \$18.92	\$20.72 / \$22.80
TT-FG-MC-M076-48-X-Z	3.00 / 76	\$6.88 / \$8.36	\$7.24 / \$9.80	\$12.84 / \$10.48	\$13.40 / \$19.64	\$20.80 / \$23.40

For the "X" value: specify either A, B, C, D, or E
 For the "Z" value: specify "S" for Stainless Steel or "I" for Inconel

OTHER CUSTOM SIZES & SHAPES AVAILABLE – PLEASE INQUIRE



ProSil™ Silica/Glass Blended Fabric Tadpole Tape with Rope or Wire Mesh Core
1350°F / 732°C TadpoleTape™ High Temperature & Heat Resistant



Made from our proprietary blended silica/fiberglass heavy duty fabric, this is a soft and resilient gasket material for effective sealing on metal flanges and where limited bolting force is available – and where doors and other closures rest on the bulb.

Outperforms standard fiberglass tadpole tapes in higher temperature applications. Remains soft and workable at temperatures where fiberglass tapes become brittle

Standard Rolls of 50 and 100 feet. For By-The-Foot pricing add 25% to price shown. **This product has a \$200 minimum order value.**

1350°F / 732°C continuous rating: Highly flexible and conformable.

TadpoleTape™ Very High Temperature & Heat Resistant
ProSil™ Blended Silica/Glass with Rope Core

Part Number	Over All Width in / mm	Price per Foot By Bulb Size: A / B / C / D / E (in / mm)				
		Rope Core / Inconel Mesh Core				
		"A" 3/8" / 7.9	"B" 1/2" / 13	"C" 5/8" / 15.8	"D" 3/4" / 19	"E" 1" / 25
TT-FGS-RC-M025-16-X	1.00 / 25	\$ 5.90	\$ 6.46	NA	NA	NA
TT-FGS-RC-M032-20-X	1.25 / 32	\$ 6.00	\$ 6.86	\$ 7.46	\$ 8.57	NA
TT-FGS-RC-M038-24-X	1.50 / 38	\$ 6.70	\$ 7.30	\$ 7.90	\$ 8.96	NA
TT-FGS-RC-M044-28-X	1.75 / 44	\$ 7.13	\$ 7.66	\$ 8.26	\$ 9.40	\$ 11.20
TT-FGS-RC-M051-32-X	2.00 / 51	\$ 7.50	\$ 8.10	\$ 8.70	\$ 9.80	\$ 11.56
TT-FGS-RC-M063-40-X	2.50 / 63	\$ 8.33	\$ 8.90	\$ 9.50	\$ 10.63	\$ 12.36
TT-FGS-RC-M076-48-X	3.00 / 76	\$ 9.13	\$ 9.70	\$ 10.30	\$ 11.46	\$ 13.20

For the "X" value: specify either A, B, C, D, or E

TadpoleTape™ Very High Temperature & Heat Resistant
ProSil™ Blended Silica/Glass with Inconel 600 Mesh Core

Part Number	Over All Width in / mm	Price per Foot By Bulb Size: A / B / C / D / E (in / mm)				
		Rope Core / Inconel Mesh Core				
		"A" 3/8" / 7.9	"B" 1/2" / 13	"C" 5/8" / 15.8	"D" 3/4" / 19	"E" 1" / 25
TT-FGS-MC-M025-16-X	1.00 / 25	\$ 8.63	\$ 9.10	\$ NA	NA	NA
TT-FGS-MC-M032-20-X	1.25 / 32	\$ 9.43	\$ 9.86	\$ 10.80	\$ 15.23	NA
TT-FGS-MC-M038-24-X	1.50 / 38	\$ 9.86	\$ 10.73	\$ 11.23	\$ 15.53	NA
TT-FGS-MC-M044-28-X	1.75 / 44	\$ 10.26	\$ 11.13	\$ 11.60	\$ 16.00	\$ 17.96
TT-FGS-MC-M051-32-X	2.00 / 51	\$ 10.66	\$ 11.53	\$ 11.80	\$ 16.33	\$ 18.20
TT-FGS-MC-M063-40-X	2.50 / 63	\$ 11.46	\$ 12.33	\$ 12.83	\$ 17.10	\$ 18.50
TT-FGS-MC-M076-48-X	3.00 / 76	\$ 12.26	\$ 13.13	\$ 13.63	\$ 17.86	\$ 19.96

For the "X" value: specify either A, B, C, D, or E

OTHER CUSTOM SIZES & SHAPES AVAILABLE – PLEASE INQUIRE



**ProSilMax™ Silica/Glass Blended Fabric with Wire Insert
 Tadpole Tape with Rope or Wire Mesh Core
 1350°F / 732°C TadpoleTape™ High Temperature & Heat Resistant**



Made from our proprietary blended silica/fiberglass heavy duty fabric, this is a soft and resilient gasket material for effective sealing on metal flanges and where limited bolting force is available – and where doors and other closures rest on the bulb.

The fabric has a wire insert for additional strength and dimensional stability.

Outperforms standard fiberglass tadpole tapes in higher temperature applications. Remains soft and workable at temperatures where fiberglass tapes become brittle.

Standard Rolls of 50 and 100 feet. For By-The-Foot pricing add 25% to price shown. **This product has a \$200 minimum order value.**

1300°F / 704°C continuous rating: Highly flexible and conformable.

TadpoleTape™ Very High Temperature & Heat Resistant ProSilMax™ Blended Silica/Glass with Rope Core						
Part Number	Over All Width in / mm	Price per Foot By Bulb Size: A / B / C / D / E (in / mm)				
		Rope Core / Inconel Mesh Core				
		"A" 3/8" / 7.9	"B" 1/2" / 13	"C" 5/8" / 15.8	"D" 3/4" / 19	"E" 1" / 25
TT-PROSIL-RC-M025-16-X	1.00 / 25	\$ 5.90	\$ 6.46	NA	NA	NA
TT-PROSIL-RC-M032-20-X	1.25 / 32	\$ 6.00	\$ 6.86	\$ 7.46	\$ 8.57	NA
TT-PROSIL-RC-M038-24-X	1.50 / 38	\$ 6.70	\$ 7.30	\$ 7.90	\$ 8.96	NA
TT-PROSIL-RC-M044-28-X	1.75 / 44	\$ 7.13	\$ 7.66	\$ 8.26	\$ 9.40	\$ 11.20
TT-PROSIL-RC-M051-32-X	2.00 / 51	\$ 7.50	\$ 8.10	\$ 8.70	\$ 9.80	\$ 11.56
TT-PROSIL-RC-M063-40-X	2.50 / 63	\$ 8.33	\$ 8.90	\$ 9.50	\$ 10.63	\$ 12.36
TT-PROSIL-RC-M076-48-X	3.00 / 76	\$ 9.13	\$ 9.70	\$ 10.30	\$ 11.46	\$ 13.20

For the "X" value: specify either A, B, C, D, or E

TadpoleTape™ Very High Temperature & Heat Resistant ProSilMax™ Blended Silica/Glass with Inconel 600 Mesh Core						
Part Number	Over All Width in / mm	Price per Foot By Bulb Size: A / B / C / D / E (in / mm)				
		Rope Core / Inconel Mesh Core				
		"A" 3/8" / 7.9	"B" 1/2" / 13	"C" 5/8" / 15.8	"D" 3/4" / 19	"E" 1" / 25
TT-PROSIL-MC-M025-16-X	1.00 / 25	\$ 8.63	\$ 9.10	\$ NA	NA	NA
TT-PROSIL-MC-M032-20-X	1.25 / 32	\$ 9.43	\$ 9.86	\$ 10.80	\$ 15.23	NA
TT-PROSIL-MC-M038-24-X	1.50 / 38	\$ 9.86	\$ 10.73	\$ 11.23	\$ 15.53	NA
TT-PROSIL-MC-M044-28-X	1.75 / 44	\$ 10.26	\$ 11.13	\$ 11.60	\$ 16.00	\$ 17.96
TT-PROSIL-MC-M051-32-X	2.00 / 51	\$ 10.66	\$ 11.53	\$ 11.80	\$ 16.33	\$ 18.20
TT-PROSIL-MC-M063-40-X	2.50 / 63	\$ 11.46	\$ 12.33	\$ 12.83	\$ 17.10	\$ 18.50
TT-PROSIL-MC-M076-48-X	3.00 / 76	\$ 12.26	\$ 13.13	\$ 13.63	\$ 17.86	\$ 19.96

For the "X" value: specify either A, B, C, D, or E

OTHER CUSTOM SIZES & SHAPES AVAILABLE – PLEASE INQUIRE



Vermiculite Coated Fiberglass Tadpole Tape / Rope or Wire Mesh Core 1500°F / 815°C TadpoleTape™ FlameShield™ 1500 High Temperature & Heat Resistant



Made from our heavy duty fabrics and ropes/wire mesh, this is a soft and resilient gasket material for effective sealing on light metal flanges and where limited bolting force is available – and where doors and other closures rest on the bulb of the packing.

Standard lengths of 50 and 100 feet. For By-The-Foot pricing: add 25% to price shown. **This product has a \$25 minimum order value.**

1500°F / 815°C continuous rating. Certified to meet the requirements of ASTM E 162, ASTM E 662 & SMP 800-C for surface flammability, smoke and toxic gas generation.

Fabricated from E fiberglass that will not burn and will withstand continuous exposure to temperatures of 1500°F / 815°C. This product resists most acids and alkalis and is unaffected by most bleaches and solvents. It is highly flexible and conformable. Meets Federal Railroad Administration requirements for surface flammability and rate of smoke generation.

TadpoleTape™ Vermiculite Coated Fiberglass with Rope Core						
Part Number	Over All Width in / mm	Price per Foot By Bulb Size: A / B / C / D / E fractional inch / decimal inch / mm				
		"A"	"B"	"C"	"D"	"E"
		3/8" / .375 / 7.9	1/2" / .500 / 13	5/8" / .625 / 15.8	3/4" / .750 / 19	1" / 1.000 / 25
TT-FG-VC-RC-M025-16-X	1.00 / 25	\$ 4.20	\$ 4.64	\$ 5.24	NA	NA
TT-FG-VC-RC-M032-20-X	1.25 / 32	\$ 4.36	\$ 4.80	\$ 5.52	NA	NA
TT-FG-VC-RC-M038-24-X	1.50 / 38	\$ 4.64	\$ 5.00	\$ 5.64	\$ 6.32	NA
TT-FG-VC-RC-M044-28-X	1.75 / 44	\$ 4.80	\$ 5.20	\$ 5.96	\$ 6.56	\$ 10.32
TT-FG-VC-RC-M051-32-X	2.00 / 51	\$ 4.88	\$ 5.52	\$ 6.44	\$ 6.76	\$ 10.56
TT-FG-VC-RC-M063-40-X	2.50 / 63	\$ 5.48	\$ 5.92	\$ 7.01	\$ 7.20	\$ 10.82
TT-FG-VC-RC-M076-48-X	3.00 / 76	\$ 5.92	\$ 6.36	\$ 7.32	\$ 7.72	\$ 11.05

TadpoleTape™ Vermiculite Coated Fiberglass with Stainless Steel or Inconel 600 Mesh Core						
Part Number	Over All Width in / mm	Price per Foot By Bulb Size: A / B / C / D / E fractional inch / decimal inch / mm				
		"A"	"B"	"C"	"D"	"E"
		3/8" / .375 / 7.9 SS / Inconel	1/2" / .500 / 13 SS / Inconel	5/8" / .625 / 15.8 SS / Inconel	3/4" / .750 / 19 SS / Inconel	1" / 1.00 / 25 SS / Inconel
TT-FG-VC-MC-M025-16-X-Z	1.00 / 25	\$7.36 / \$8.60	\$8.40 / \$9.16	\$9.36 / \$12.20	NA	NA
TT-FG-VC-MC-M032-20-X-Z	1.25 / 32	\$7.68 / \$8.72	\$8.72 / \$9.28	\$9.72 / \$12.48	NA	NA
TT-FG-VC-MC-M038-24-X-Z	1.50 / 38	\$7.80 / \$8.92	\$9.08 / \$9.44	\$10.04 / \$12.60	\$18.08 / \$18.48	NA
TT-FG-VC-MC-M044-28X-Z	1.75 / 44	\$8.32 / \$9.08	\$9.40 / \$9.60	\$10.60 / \$12.88	\$18.44 / \$18.64	\$22.12 / \$22.36
TT-FG-VC-MC-M051-32-X-Z	2.00 / 51	\$8.88 / \$9.20	\$9.84 / \$9.92	\$11.24 / \$13.32	\$18.92 / \$19.45	\$22.60 / \$22.87
TT-FG-VC-MC-M063-40-X-Z	2.50 / 63	\$9.52 / \$9.72	\$10.64 / \$10.24	\$12.40 / \$13.80	\$19.56 / \$19.81	\$23.24 / \$23.97
TT-FG-VC-MC-M076-48-X-Z	3.00 / 76	\$10.20 / \$10.12	\$11.76 / \$10.56	\$17.72 / \$18.84	\$20.98 / \$21.76	\$23.88 / \$24.56

For the "X" value: specify either A, B, C, D, or E for the bulb size
 For the "Z" value: specify "S" for Stainless Steel or "I" for Inconel

OTHER CUSTOM SIZES & SHAPES AVAILABLE – PLEASE INQUIRE



Silica Tadpole Tape With Rope or Wire Mesh Core
1800°F / 982°C InSilMax™ TadpoleTape™ Extreme High Temperature Heat Flame Resistant



Made from our heavy duty silica fabrics and ropes, this is a soft and resilient gasket material for effective sealing on light metal flanges and where limited bolting force is available – and where doors and other closures rest on the bulb of the packing.

Standard Rolls of 50 and 100 feet.

For “By-The-Foot” pricing: add 25% to price shown:

Can be used at 1800°F / 982°C continuously.

InSilMax™ TadpoleTape™ Extreme High Temperature; Heat & Flame Resistant With Rope Core						
Part Number	Over All Width in / mm	Price per Foot By Bulb Size: A / B / C / D / E				
		in / mm				
		“A” 3/8” / .375 / 7.9	“B” 1/2” / .500 / 13	“C” 5/8” / .625 / 15.8	“D” 3/4” / .750 / 19	“E” 1” / 1.000 / 25
TT-S-RC-M025-16-X	1.00 / 25	\$ 7.64	\$ 7.92	\$ 9.64	NA	NA
TT-S-RC-M032-20-X	1.25 / 32	\$ 8.48	\$ 8.68	\$ 10.36	NA	NA
TT-S-RC-M038-24-X	1.50 / 38	\$ 8.72	\$ 9.24	\$ 11.40	\$ 12.44	NA
TT-S-RC-M044-28-X	1.75 / 44	\$ 9.32	\$ 10.08	\$ 12.28	\$ 13.08	\$ 15.92
TT-S-RC-M051-32-X	2.00 / 51	\$ 10.28	\$ 10.60	\$ 12.76	\$ 13.84	\$ 16.29
TT-S-RC-M063-40-X	2.50 / 63	\$ 11.52	\$ 11.96	\$ 13.40	\$ 15.40	\$ 16.87
TT-S-RC-M076-48-X	3.00 / 76	\$ 13.16	\$ 13.40	\$ 14.24	\$ 16.96	\$ 18.97

InSilMax™ TadpoleTape™ Extreme High Temperature; Heat & Flame Resistant with Stainless Steel or Inconel 600 Mesh Core						
Part Number	Over All Width in / mm	Price per Foot By Bulb Size: A / B / C / D / E				
		in / mm and choice of Stainless Steel / Inconel Bulb				
		“A” 3/8” / .375 / 7.9 SS / Inconel	“B” 1/2” / .500 / 13 SS / Inconel	“C” 5/8” / .625 / 15.8 SS / Inconel	“D” 3/4” / .750 / 19 SS / Inconel	“E” 1” / 1.000 / 25 SS / Inconel
TT-S-MC-M025-16-X-Z	1.00 / 25	\$7.72 / \$8.40	\$8.60 / \$9.60	\$9.76 / \$10.64	NA	NA
TT-S-MC-M032-20-X-Z	1.25 / 32	\$8.64 / \$9.60	\$8.92 / \$9.92	\$10.52 / \$11.44	NA	NA
TT-S-MC-M038-24-X-Z	1.50 / 38	\$8.88 / \$9.88	\$9.28 / \$10.32	\$11.68 / \$12.76	\$15.40 / \$19.88	NA
TT-S-MC-M044-28-X-Z	1.75 / 44	\$9.52 / \$10.60	\$10.20 / \$11.04	\$12.44 / \$13.60	\$15.88 / \$20.28	\$18.80 / \$23.24
TT-S-MC-M051-32-X-Z	2.00 / 51	\$10.28 / \$11.44	\$10.80 / \$11.98	\$14.32 / \$15.80	\$16.32 / \$20.60	\$19.24 / \$24.16
TT-S-MC-M063-40-X-Z	2.50 / 63	\$11.72 / \$13.04	\$12.04 / \$13.40	\$16.08 / \$17.80	\$17.24 / \$21.36	\$20.16 / \$25.24
TT-S-MC-M076-48-X-Z	3.00 / 76	\$13.36 / \$14.60	\$13.52 / \$15.04	\$16.60 / \$18.32	\$18.16 / \$22.12	\$21.08 / \$25.96

For the “X” value: specify either A, B, C, D, or E for the bulb size

For the “Z” value: specify “S” for Stainless Steel or “I” for Inconel

OTHER CUSTOM SIZES AND SHAPES AVAILABLE – PLEASE INQUIRE



Silica Tadpole Tape With Rope or Wire Mesh Core
1900°F / 1037°C InSilMax™ XT TadpoleTape™ Extreme High Temperature Heat
Flame Resistant



Made from our highest purity heavy duty silica fabrics and ropes, this is a soft and resilient gasket material for effective sealing on metal flanges and where limited bolting force is available – and where doors and other closures rest on the bulb of the tape.

Standard Rolls of 50 and 100 feet.

For By-The-Foot pricing: add 25% to price shown:

Produced from an extremely pure base fiber (SiO₂) and can be used at 1900°F / 1037°C continuously.

InSilMax™ XT TadpoleTape™ Extreme High Temperature; Heat & Flame Resistant With Rope Core						
Part Number	Over All Width in / mm	Price per Foot By Bulb Size: A / B / C / D / E in / mm				
		"A"	"B"	"C"	"D"	"E"
		3/8" / .375 / 7.9	1/2" / .500 / 13	5/8" / .625 / 15.8	3/4" / .750 / 19	1" / 1.00 / 25
TT-SXT-RC-M025-16-X	1.00 / 25	\$ 8.79	\$ 9.11	\$ 11.09	NA	NA
TT-SXT-RC-M032-20-X	1.25 / 32	\$ 9.75	\$ 9.98	\$ 11.91	NA	NA
TT-SXT-RC-M038-24-X	1.50 / 38	\$ 10.03	\$ 10.63	\$ 13.11	\$ 14.31	NA
TT-SXT-RC-M044-28-X	1.75 / 44	\$ 10.72	\$ 11.59	\$ 14.13	\$ 15.05	\$ 18.31
TT-SXT-RC-M051-32-X	2.00 / 51	\$ 11.82	\$ 12.19	\$ 14.67	\$ 15.92	\$ 18.74
TT-SXT-RC-M063-40-X	2.50 / 63	\$ 13.25	\$ 13.75	\$ 15.41	\$ 17.71	\$ 19.40
TT-SXT-RC-M076-48-X	3.00 / 76	\$ 15.13	\$ 15.41	\$ 16.38	\$ 17.81	\$ 21.82

InSilMax™ XT TadpoleTape™ Extreme High Temperature; Heat & Flame Resistant with Stainless Steel or Inconel 600 Mesh Core						
Part Number	Over All Width in / mm	Price per Foot By Bulb Size: A / B / C / D / E in / mm and choice of Stainless Steel / Inconel Bulb				
		"A"	"B"	"C"	"D"	"E"
		3/8" / .375 / 7.9 SS / Inconel	1/2" / .500 / 13 SS / Inconel	5/8" / .625 / 15.8 SS / Inconel	3/4" / .750 / 19 SS / Inconel	1" / 1.000 / 25 SS / Inconel
TT-SXT-MC-M025-16-X-Z	1.00 / 25	\$8.89 / \$9.66	\$9.89 / \$11.04	\$11.22 / \$11.17	NA	NA
TT-SXT-MC-M032-20-X-Z	1.25 / 32	\$9.94 / \$11.04	\$10.26 / \$11.41	\$12.09 / \$13.16	NA	NA
TT-SXT-MC-M038-24-X-Z	1.50 / 38	\$10.21 / \$11.36	\$10.67 / \$11.87	\$13.43 / \$14.67	\$17.71 / \$22.86	NA
TT-SXT-MC-M044-28-X-Z	1.75 / 44	\$10.95 / \$12.19	\$11.73 / \$12.70	\$14.31 / \$15.64	\$18.26 / \$23.32	\$21.62 / \$26.73
TT-SXT-MC-M051-32-X-Z	2.00 / 51	\$11.82 / \$13.16	\$12.42 / \$13.78	\$16.47 / \$18.17	\$18.77 / \$23.69	\$22.13 / \$27.78
TT-SXT-MC-M063-40-X-Z	2.50 / 63	\$13.48 / \$14.99	\$13.85 / \$15.41	\$18.49 / \$20.47	\$19.83 / \$22.43	\$23.18 / \$29.03
TT-SXT-MC-M076-48-X-Z	3.00 / 76	\$15.36 / \$16.79	\$15.55 / \$17.30	\$19.09 / \$21.07	\$20.88 / \$25.43	\$24.24 / \$29.85

For the "X" value: specify either A, B, C, D, or E for the bulb size
 For the "Z" value: specify "S" for Stainless Steel or "I" for Inconel

OTHER CUSTOM SIZES & SHAPES AVAILABLE – PLEASE INQUIRE



Ceramic Fiber Tadpole Tape With Rope or Wire Mesh Core
2000°F / 1093°C CerMax™ TadpoleTape™ Extreme High Temperature Heat Flame Resistant



Made from our highest temperature ceramic fiber inonel wire inserted materials, this is a soft and resilient gasket material for effective sealing on metal flanges and where limited bolting force is available – and where doors and other closures rest on the bulb of the tape.

Standard Rolls of 50 and 100 feet.

For By-The-Foot pricing: add 25% to price shown:

Can be used at 2000°F / 1093°C continuously.

CerMax™ TadpoleTape™ Extreme High Temperature; Heat & Flame Resistant With Rope Core						
Part Number	Over All Width in / mm	Price per Foot By Bulb Size: A / B / C / D / E in / mm				
		"A" 3/8" / .375 / 7.9	"B" 1/2" / .500 / 13	"C" 5/8" / .625 / 15.8	"D" 3/4" / .750 / 19	"E" 1" / 1.000 / 25
TT-C-RC-M038-24-X	1.50 / 38	\$ CALL	\$ CALL	\$ CALL	\$ CALL	NA
TT-C-RC-M044-28-X	1.75 / 44	\$ CALL	\$ CALL	\$ CALL	\$ CALL	\$ CALL
TT-C-RC-M051-32-X	2.00 / 51	\$ CALL	\$ CALL	\$ CALL	\$ CALL	\$ CALL
TT-C-RC-M063-40-X	2.50 / 63	\$ CALL	\$ CALL	\$ CALL	\$ CALL	\$ CALL
TT-C-RC-M076-48-X	3.00 / 76	\$ CALL	\$ CALL	\$ CALL	\$ CALL	\$ CALL

CerMax™ TadpoleTape™ Extreme High Temperature; Heat & Flame Resistant with Inconel 600 Mesh Core						
Part Number	Over All Width in / mm	Price per Foot By Bulb Size: A / B / C / D / E in / mm and Inconel Mesh Bulb				
		"A" 3/8" / .375 / 7.9 SS / Inconel	"B" 1/2" / .500 / 13 SS / Inconel	"C" 5/8" / .625 / 15.8 SS / Inconel	"D" 3/4" / .750 / 19 SS / Inconel	"E" 1" / 1.000 / 25 SS / Inconel
TT-C-MC-M038-24-X	1.50 / 38	\$ CALL	\$ CALL	\$ CALL	\$ CALL	NA
TT-C-MC-M044-28-X	1.75 / 44	\$ CALL	\$ CALL	\$ CALL	\$ CALL	\$ CALL
TT-C-MC-M051-32-X	2.00 / 51	\$ CALL	\$ CALL	\$ CALL	\$ CALL	\$ CALL
TT-C-MC-M063-40-X	2.50 / 63	\$ CALL	\$ CALL	\$ CALL	\$ CALL	\$ CALL
TT-C-MC-M076-48-X	3.00 / 76	\$ CALL	\$ CALL	\$ CALL	\$ CALL	\$ CALL

For the "X" value: specify either A, B, C, D, or E for the bulb size
 For the "Z" value: specify "S" for Stainless Steel or "I" for Inconel

OTHER CUSTOM SIZES & SHAPES AVAILABLE – PLEASE INQUIRE

CerMax Tadpole Tape Technical Data

CerMax is alumino-silicate based refractory fiber. White and odorless. Available with either a fiberglass or wire re-inforcement. Some organic binder is present, and will smoke-off at elevated temperatures. Once the organics have smoked-off, the product will turn white again. If smoke free operation is required, then it should be heat treated before use.

Chemical & Physical Data: Total Al_2O_3 and SiO_2 > 97% (Al_2O_3 : 47%); Fe_2O_3 <1.1%. Weight Loss (1800°F) 8-10%; Refractory Fiber content >85%. Fiber diameter: 2 - 4 microns; Fiber length: 100 - 250 mm. Fiber shrinkage (1800°F, 3 hr) <3.5%

Thermal Conductivity: 570°F: 0.84 BTU/ft²°F/in (0.12 W/m °K). 1100°F: 0.91 BTU/ft²°F/in (0.13 W/m °K). 1800°F: 1.19 BTU/ft²°F/in (0.17 W/m °K).



Fiberglass with PTFE Coating Tadpole Tape: Rope or Wire Mesh Core 550°F / 287°C TadpoleTape™ High Temperature, Heat & Chemical Resistance



- PTFE Coated Fiberglass

Made from our heavy duty fabrics and ropes/wire mesh; this is a soft and resilient gasket material for effective sealing on light metal flanges and where limited bolting force is available – and where doors and other closures rest on the bulb of the packing. This fabric offers the advantage of a non-asbestos material with higher temperature range and with excellent resistance to almost all solvents, caustics and acids. The base fabric is rated to 1000°F / 537°C. PTFE melting point is 620°F / 327°C.

Standard lengths of 50 and 100 feet. For By-The-Foot pricing: add 25% to price shown:

550°F / 287°C continuous rating

Tadpole Tape™ High Temperature & Chemical Resistance PTFE Coated Fiberglass with Rope Core						
Part Number	Over All Width in / mm	Price per Foot By Bulb Size: A / B / C / D / E in / mm				
		"A" 3/8" / .375 / 7.9	"B" 1/2" / .500 / 13	"C" 5/8" / .625 / 15.8	"D" 3/4" / .750 / 19	"E" 1" / 1.000 / 25
TT-FG-PT-RC-M025-16-X	1.00 / 25	\$ 5.56	\$ 5.80	\$ 6.52	NA	NA
TT-FG-PT-RC-M032-20-X	1.25 / 32	\$ 5.96	\$ 6.24	\$ 7.32	NA	NA
TT-FG-PT-RC-M038-24-X	1.50 / 38	\$ 6.72	\$ 6.96	\$ 8.04	\$ 7.80	NA
TT-FG-PT-RC-M044-28-X	1.75 / 44	\$ 7.48	\$ 7.72	\$ 8.80	\$ 8.60	\$ 11.72
TT-FG-PT-RC-M051-32-X	2.00 / 51	\$ 8.08	\$ 8.52	\$ 9.76	\$ 9.28	\$ 12.12
TT-FG-PT-RC-M063-40-X	2.50 / 63	\$ 9.16	\$ 9.44	\$ 10.76	\$ 10.24	\$ 12.48
TT-FG-PT-RC-M076-48-X	3.00 / 76	\$ 10.08	\$ 10.36	\$ 11.00	\$ 11.24	\$ 13.04

TadpoleTape™ High Temperature & Chemical Resistance PTFE Coated Fiberglass: with Stainless Steel or Inconel 600 Mesh Core						
Part Number	Over All Width in / mm	Price per Foot By Bulb Size: A / B / C / D / E in / mm and choice of Stainless Steel / Inconel Bulb				
		"A" 3/8" / .375 / 7.9 SS / Inconel	"B" 1/2" / .500 / 13 SS / Inconel	"C" 5/8" / .625 / 15.8 SS / Inconel	"D" 3/4" / .750 / 19 SS / Inconel	"E" 1" / 1.000 / 25 SS / Inconel
TT-FG-PT-MC-M025-16-X-Z	1.00 / 25	\$8.72 / \$11.02	\$9.12 / \$12.48	\$11.52 / \$14.00	NA	NA
TT-FG-PT-MC-M032-20-X-Z	1.25 / 32	\$9.12 / \$11.68	\$9.52 / \$13.12	\$12.28 / \$14.64	NA	NA
TT-FG-PT-MC-M038-24-X-Z	1.50 / 38	\$9.84 / \$12.00	\$10.24 / \$13.80	\$13.02 / \$15.28	\$16.36 / \$26.24	NA
TT-FG-PT-MC-M044-28-X-Z	1.75 / 44	\$10.64 / \$12.96	\$11.04 / \$14.44	\$13.76 / \$16.24	\$17.12 / \$26.92	\$25.84 / \$32.00
TT-FG-PT-MC-M051-32-X-Z	2.00 / 51	\$11.28 / \$13.64	\$11.76 / \$15.16	\$14.72 / \$17.44	\$17.80 / \$27.64	\$26.31 / \$32.80
TT-FG-PT-MC-M063-40-X-Z	2.50 / 63	\$12.28 / \$15.12	\$12.64 / \$16.60	\$15.72 / \$19.08	\$18.88 / \$29.03	\$26.55 / \$34.08
TT-FG-PT-MC-M076-48-X-Z	3.00 / 76	\$13.20 / \$16.20	\$13.56 / \$17.48	\$16.76 / \$25.56	\$19.72 / \$30.80	\$27.12 / \$35.80

For the "X" value: specify either A, B, C, D, or E
 For the "Z" value: specify "S" for Stainless Steel or "I" for Inconel

OTHER CUSTOM SIZES & SHAPES AVAILABLE – PLEASE INQUIRE

The PTFE is applied to the tadpole tape by dipping the tape through an immersion tank of liquid PTFE dispersion. The tape is then air dried as it leaves the dip tank. The result is a PTFE coating on the tape which is soft, robust and flexible; however, it can be abrasively removed from the tape with aggressive fingernail scraping, resulting in a thinner and thinner layer of ptf remaining with each pass. The PTFE also causes the yarns to be sealed and the small gaps between the yarns filled, resulting in an almost air-tight / liquid-tight tape.



White Rubber Coated Fiberglass Tadpole Tape (Tacky Cloth) with Rope Core
550°F / 287°C: Tuff-Flex™ TadpoleTape™ High Temperature *With or Without Wire Insert*



TadpoleTape™ made from Tuff-Flex™ 550 tacky cloth.

This is a widely used tadpole tape that provides a resilient and non-absorbent gasket material for service against steam, air, water and gases.

Especially useful where a rough or uneven surface or flange exists. The fabric is a fiberglass base with a special white rubber formulation. The fabric is tacky, and has a plastic film surface covering that is removed before installation. The fabric will stick to itself once the film is removed.

Wire Inserted Version: The fill (width wise) yarn for this version of the fabric has a twisted brass wired formed with it, providing additional strength and electrical conductivity/shielding.

550°F / 287°C continuous rating, excellent sealing properties as a gasket material

Tuff-Flex™ TadpoleTape™ High Temperature White Rubber Coated Fiberglass Tacky Cloth with Rope Core: with or without wire insert						
Part Number	Over All Width in / mm	Price per Foot By Bulb Size: A / B / C / D / E in / mm				
		"A" 3/8" / .375 / 7.9	"B" 1/2" / .500 / 13	"C" 5/8" / .625 / 15.8	"D" 3/4" / .750 / 19	"E" 1" / 1.000 / 25
TT-FG-TC-M025-16-X-Z	1.00 / 25	\$ 4.80	\$ 5.12	\$ 5.80	NA	NA
TT-FG-TC-M032-20-X-Z	1.25 / 32	\$ 5.00	\$ 5.56	\$ 6.24	NA	NA
TT-FG-TC-M038-24-X-Z	1.50 / 38	\$ 5.48	\$ 5.84	\$ 6.52	\$ 7.48	NA
TT-FG-TC-M044-28-X-Z	1.75 / 44	\$ 6.04	\$ 6.36	\$ 7.04	\$ 8.12	\$ 9.96
TT-FG-TC-M051-32-X-Z	2.00 / 51	\$ 6.60	\$ 6.84	\$ 7.32	\$ 8.84	\$ 11.24
TT-FG-TC-M063-40-X-Z	2.50 / 63	\$ 7.56	\$ 7.84	\$ 8.36	\$ 9.64	\$ 12.84
TT-FG-TC-M076-48-X-Z	3.00 / 76	\$ 8.56	\$ 8.92	\$ 9.40	\$ 10.76	\$ 14.44

For the "X" value in the part number specify either A, B, C, D, or E to correspond to the bulb size

For the "Z" value in the part number use "W" to specify with wire insert use "N" to specify no wire

Same price with and without wire insert

Standard Rolls of 25 and 50 feet. For By-The-Foot pricing: add 25% to price shown.

OTHER CUSTOM SIZES & SHAPES AVAILABLE – PLEASE INQUIRE

Curing: It is recommended that this material be cured in situ. This material must be heated to a minimum of 300°F within 60 minutes, then it must sit at 300°F or higher for 90 minutes for the rubber to fully cure.

Do not overtorque the material during this curing time or the rubber will be squeezed off of the base material.

If the material is not fully cured, the rubber will drip from the material causing voids. After curing the material can be exposed to a lower operational temperature.



Expanded PTFE Tadpole Tape with Rope or Wire Mesh Core
550°F / 287°C TadpoleTape™ High Temperature & Chemical Resistance



- Made from expanded PTFE (ePTFE)

Pure ePTFE tape formed into a tadpole with either a rope core or stainless steel mesh core. Excellent corrosion resistance, high pressure resistance, easy to use.

Excellent resistance to almost all solvents, caustics and acids.

PTFE melting point is 620°F / 327°C.

Standard Roll of 100 feet. Sold in Full Rolls Only

TadpoleTape™ ePTFE with Rope Core						
Part Number	Over All Width in / mm	Price per Roll By Bulb Size: A / B / C / D / E				
		fractional inch / decimal inch / mm				
		"A" 3/8" / .375 / 7.9	"B" 1/2" / .500 / 13	"C" 5/8" / .625 / 16	"D" 3/4" / .750 / 19	"E" 1" / 1.00 / 25
TT-EPT-RC-M025-16-X	1.00 / 25	\$ 915.33	\$ 1147.50	NA	NA	NA
TT-EPT-RC-M032-20-X	1.25 / 32	\$ 1092.67	\$ 1340.00	\$ 1240.33	NA	NA
TT-EPT-RC-M038-24-X	1.50 / 38	\$ 1250.67	\$ 1497.00	\$ 1422.67	\$ 1512.00	NA
TT-EPT-RC-M044-28-X	1.75 / 44	\$ 1352.50	\$ 1672.33	\$ 2040.00	\$ 2153.33	NA
TT-EPT-RC-M051-32-X	2.00 / 51	\$ 1936.67	\$ 2346.67	\$ 2273.33	\$ 2386.67	\$ 2690.00
TT-EPT-RC-M063-40-X	2.50 / 63	\$ 2430.00	\$ 2790.00	\$ 2740.00	\$ 2853.00	\$ 3156.67
TT-EPT-RC-M076-48-X	3.00 / 76	\$ 2990.00	\$ 3233.00	\$ 3206.67	\$ 3320.00	\$ 3623.33

TadpoleTape™ ePTFE with Stainless Steel Mesh Core						
Part Number	Over All Width in / mm	Price per Roll By Bulb Size: A / B / C / D / E				
		fractional inch / decimal inch / mm				
		"A" 3/8" / .375 / 7.9	"B" 1/2" / .500 / 13	"C" 5/8" / .625 / 16	"D" 3/4" / .750 / 19	"E" 1" / 1.00 / 25
TT-EPT-MC-M025-16-X	1.00 / 25	\$ 1376.67	\$ 1456.67	NA	NA	NA
TT-EPT-MC-M032-20-X	1.25 / 32	\$ 1598.00	\$ 1695.00	\$ 1823.33	NA	NA
TT-EPT-MC-M038-24-X	1.50 / 38	\$ 1798.00	\$ 1896.00	\$ 2056.67	\$ 2453.33	NA
TT-EPT-MC-M044-28-X	1.75 / 44	\$ 1930.00	\$ 2123.33	\$ 2290.00	\$ 2686.67	NA
TT-EPT-MC-M051-32-X	2.00 / 51	\$ 2150.00	\$ 2346.67	\$ 2523.33	\$ 2920.00	\$ 3306.67
TT-EPT-MC-M063-40-X	2.50 / 63	\$ 2643.33	\$ 2790.00	\$ 2990.00	\$ 3386.67	\$ 3773.33
TT-EPT-MC-M076-48-X	3.00 / 76	\$ 3203.33	\$ 3233.33	\$ 3456.67	\$ 3853.33	\$ 4240.00

For the "X" value: specify either A, B, C, D, or E for the bulb size

OTHER SIZES AVAILABLE – PLEASE INQUIRE

TTWearGuard

Custom Size and Custom Construction TadpoleTape™

Our fabrication shop can produce almost any size and shape gasket, tadpole shape or almost any other shape.

Some of the common shapes include double bulb, square bulb, and metal mesh covered.

To assist our fabrication shop, any sketch, drawing, or photo of an existing item would be useful.

Please contact us to obtain a price and time quotation.

Lacing Tape

NyLace™ Nylon Lacing Tape	2-118
PolyLace™ Polyester Dacron Lacing Tape	2-119
PtLace™ PTFE Lacing Tape	2-120
GlasLace™ Fiberglass Lacing Tape	2-121
NMXLace™ Nomex Lacing Tape	2-122

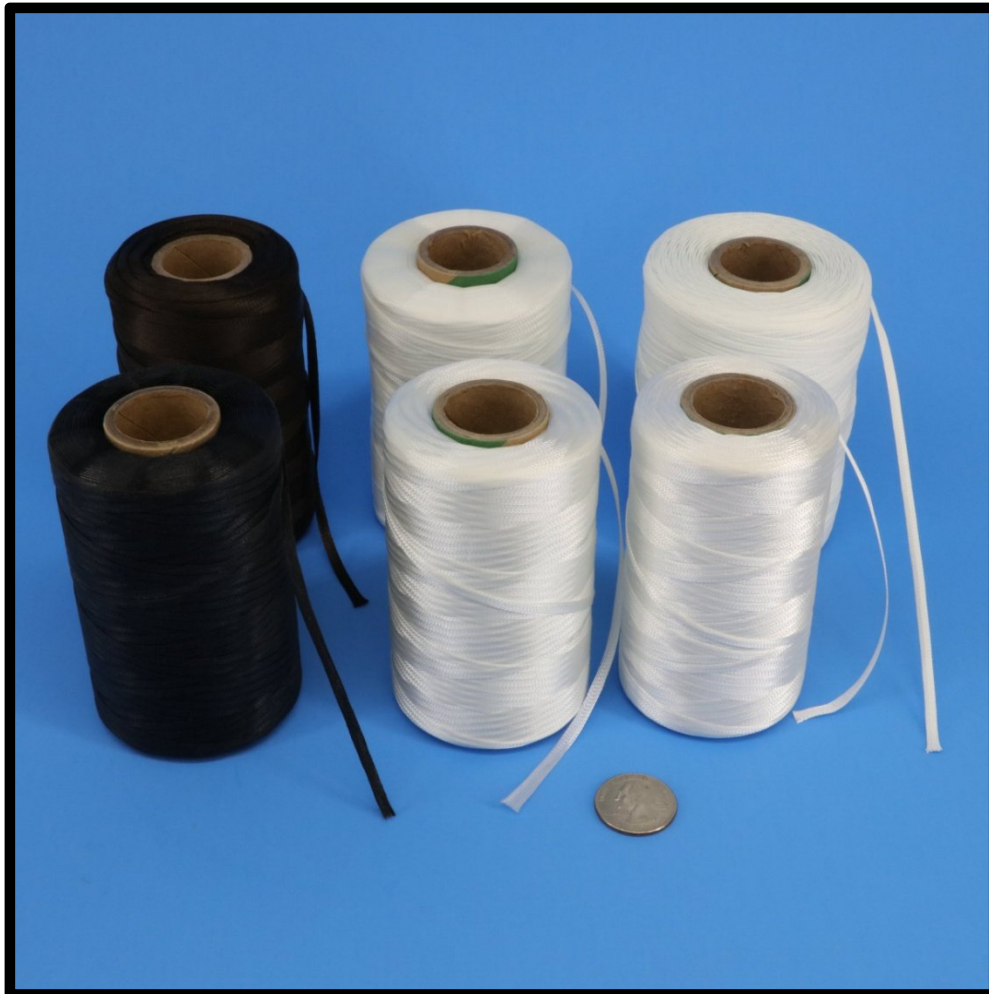



Nylon® Lacing Tape A-A-52080 Type I / MIL-T-43435
 Heat Resistant High Strength Lacing Tape
 - Natural, Wax or Synthetic Rubber Finish
 -67°F to 250°F - Melting Point 478°F



- General purpose lacing tape.
- Color: Natural or Black
- Good abrasion resistance and tensile strength.



Nylon® Lacing Tape - A-A-52080 Type I / MIL-T-43435 -67°F to 250°F							
Part Number	Mil Spec Size	Width		Thickness		Spool Length feet	Price Finish A / B / C
		Min / Max inches	Min / Max inches	Min / Max inches	Min / Max inches		
T-LACE-NY-1-X-Y	1	0.180	0.220	0.013	0.019	750	\$ 33.63 / 55.00 / 40.50
T-LACE-NY-2-X-Y	2	0.099	0.121	0.012	0.018	750	\$ 22.75 / 37.50 / 25.80
T-LACE-NY-3-X-Y	3	0.077	0.094	0.011	0.017	1500	\$ 22.50 / 38.75 / 26.93
T-LACE-NY-4-X-Y	4	0.054	0.066	0.009	0.015	1500	\$ 19.38 / 33.75 / 27.75
T-LACE-NY-5-X-Y	5	0.045	0.055	0.006	0.014	1500	\$ 16.25 / 23.37 / 19.50

Above Pricing is for Natural – For Black add 30%

**For the “X” value in the part number specify either:
 “A” for Natural, “B” for Wax, or “C” for Synthetic Rubber finish**

**For the “Y” value in the part number: use “N” for Natural
 use “B” to specify Black**

\$100.00 Minimum Order



Polyester Dacron® Lacing Tape A-A-52081 Type II / MIL-T-43435
Heat Resistant High Strength Lacing Tape
 - Natural, Wax or Synthetic Rubber Finish
 -99°F to 350°F - Melting Point 482°F



- General purpose lacing tape, superior knot tying and holding compared to Nylon.
- Suitable for Aviation / Aerospace applications
- Color: Finish A / Natural or Black
 Finish B & C / Natural, Black or Red
- Good abrasion resistance and tensile strength.



Polyester Dacron Lacing Tape - A-A-52081 Type II / MIL-T-43435							
-99°F to 350°F							
Part Number	Mil Spec Size	Width		Thickness		Spool Length feet	Price Finish A / B / C
		Min / Max inches	Min / Max inches	Min / Max inches	Min / Max inches		
T-LACE-DA-1-X-Y	1	0.180	0.220	0.013	0.019	750	\$ 30.87 / 57.50 / 35.10
T-LACE-DA-2-X-Y	2	0.099	0.121	0.012	0.018	750	\$ 27.37 / 32.50 / 31.25
T-LACE-DA-3-X-Y	3	0.077	0.094	0.011	0.017	1500	\$ 20.62 / 36.50 / 25.00
T-LACE-DA-4-X-Y	4	0.054	0.066	0.009	0.015	1500	\$ 17.25 / 30.87 / 20.25
T-LACE-DA-5-X-Y	5	0.045	0.055	0.006	0.014	1500	\$ 16.87 / 28.12 / 18.12

Above Pricing is for Natural – For Black or Red add 15%

For the “X” value in the part number specify either:
 “A” for Natural, “B” for Wax, or “C” for Synthetic Rubber finish

For the “Y” value in the part number: use “N” for Natural
 use “B” for Black
 use “R” for Red

\$100.00 Minimum Order



PTFE Fluorocarbon (Teflon®) Lacing Tape A-A-52082 Type III / MIL-T-43435
Heat & Chemical Resistant Lacing Tape
 - No Finish
 -99°F to 450°F - Melting Point 620°F

- Suitable for aircraft engine applications.
- Natural (Brown/Tan Color)



PTFE Fluorocarbon (Teflon) Lacing Tape - A-A-52082 Type III / MIL-T-43435							
-99°F to 450°F							
Part Number	Mil Spec Size	Width		Thickness		Spool Length feet	Price
		Min / Max inches	Min / Max inches	Min / Max inches	Min / Max inches		
T-LACE-PT-2	2	0.108	0.132	0.009	0.014	750	\$ 123.50
T-LACE-PT-4	4	0.059	0.072	0.009	0.014	1500	\$ 109.50

Fiberglass (E-grade) Lacing Tape A-A-52083 Type IV / MIL-T-43435
 Heat & Very High Temperature Resistant Non Flammable Lacing Tape
 - Natural with PTFE finish
 -67°F to 900°F - Melting Point 2100°F



- Very high temperature applications.
- Low elongation. Not affected by moisture.
- Color: Natural



Fiberglass Lacing Tape - A-A-52083 Type IV / MIL-T-43435
 -67°F to 900°F

Part Number	Mil Spec Size	Width		Thickness		Spool Length feet	Price
		Min / Max inches	Min / Max inches	Min / Max inches	Min / Max inches		
T-LACE-FG-1	1	0.203	0.248	0.013	0.019	750	\$ 123.00
T-LACE-FG-2	2	0.099	0.121	0.013	0.019	750	\$ 99.00
T-LACE-FG-3	3	0.077	0.094	0.013	0.019	1500	\$ 143.50
T-LACE-FG-4	4	0.054	0.066	0.013	0.019	1500	\$ 105.00



Nomex® Meta Aramid Lacing Tape A-A-52084 Type V / MIL-T-43435
 Heat & Very High Temperature Resistant Non Flammable Lacing Tape
 - Natural or Synthetic Rubber finish
 -67°F to 500°F - Melting Point 700°F



- Very high temperature applications.
- Non-flammable.
- Suitable for aircraft wiring applications.
- Color: Natural



Nomex® Meta-Aramid Lacing Tape - A-A-52084 Type V / MIL-T-43435 -67°F to 500°F							
Part Number	Mil Spec Size	Width		Thickness		Spool Length feet	Price A or C
		Min / Max inches	Min / Max inches	Min / Max inches	Min / Max inches		
T-LACE-NMX-1-X	1	0.180	0.220	0.013	0.019	750	\$ 288.00
T-LACE-NMX-2-X	2	0.099	0.121	0.011	0.017	750	\$ 153.00
T-LACE-NMX-3-X	3	0.068	0.083	0.009	0.015	1500	\$ 162.50
T-LACE-NMX-4-X	4	0.050	0.061	0.007	0.013	1500	\$ 134.00

For the “X” value in the part number specify either:
 “A” for Natural or “C” for Synthetic Rubber finish

High Temperature, Heat, Flame, Fire, Molten Metal & Weld Splatter Protection Materials

Fax Orders: 610-340-9054 Telephone Orders: 610-906-3549 orders@abthermal.com

Rope & Packing

Kevlar Aramid Rope	3-1
Solid Silicone Rubber Cord/Rope	3-2
Silicone Rubber Coated Fiberglass	3-3
Acrylic Fiber with PTFE Impregnation	3-4
Pure PTFE Square Braid	3-5
Fiberglass with PTFE Coating: Round Soft / Round Dense / Twisted / Square	3-6
Graphite Coated PTFE Rope	3-9
Fiberglass: Knitted Round Soft / Knitted Round Dense / Round Twisted / Square Braided	3-10
Fiberglass Compression Gasket Rope – Clip Mounting – Hollow Core	3-16
Fiberglass Braided Rope with Stainless Mesh Core	3-17
Fiberglass with Wire Jacket	3-19
Fiberglass with Graphite Impregnation: Round Soft / Round Dense / Square	3-20
Graphite Square Braided / With Wire / With Carbon Edges	3-23
Fiberglass with Vermiculite Coating: Soft / Dense / Twisted / Square	3-24
Silica: Knit / Twisted / Square	3-28
Ceramic: Braided Knit / Twisted / Square	3-31
Stainless Steel / Inconel Mesh Rope	3-34



Silicone Rubber Cord/Rope Page 3-1
Silicone Rubber Sponge Cord 3-2



Silicone Rubber Coated
Fiberglass Rope Page 3-3



High Temperature & Chemical
Resistance Rope with PTFE:
Knitted, Twisted, Square
Page 3-4 / 3-7



Very High Temperature
Ropes: Knitted, Twisted,
Square. Page 3-8 / 3-13

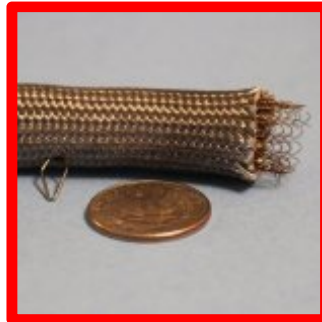

High Temperature Hollow
Gasket Rope with Sleeve
Core - Clip Mount
Page 3-14



Very High Temperature
Rope with Wire Mesh Core
Page 3-15



Very High Temperature Wire
Jacketed Seals. Page 3-16



Very High Temperature Rope
with Graphite: Soft, Dense,
Square. Page 3-17 - 3-19



Vermiculite Coated Very High
Temperature Rope: Knitted,
Twisted, Square.
Page 3-20 / 3-23



Extreme Temperature Silica
Rope: Knitted, Twisted, Square
Page 3-24 / 3-26



Extreme Temperature Ceramic
Rope: Knitted, Twisted, Square
Page 3-27 / 3-29



Stainless Steel Mesh Rope
Page 3-30



Kevlar® 12-Strand Single Braid Rope
320°F / 160°C: Continuous Rating – Higher Temperature for Shorter Periods
FlameShield™ High Temperature, Heat Resistant High Strength & Cut Resistant



- 100% Kevlar rope. 12-Strand single braid.
- Fibers are 20 times stronger than steel for the same diameter.
- Highly cut resistant.
- Low stretch, high strength.
- Available in natural (yellow) color.
- Not recommended for use over pulleys or repetitive flexing applications.
- Specific gravity 1.44; Elongation at break 1.5-4.5%

320°F / 160°C maximum continuous rating. Short term exposure to 572°F / 300°C

FlameShield™ High Temperature & Heat Resistant 12-Strand Single Braided Kevlar® Rope - Premium					
Part Number	Nominal OD	Circumference in / mm	Average Tensile Lb / kg	Price per Spool / Wt (lbs)	Price per Foot
R-K-M006-02-X	1/8" / 3.1 mm	3/8" / 9.7	1,500 / 682	\$ 682.16 / 4	\$ 2.27
R-K-M006-03-X	3/16" / 4.7 mm	9/16" / 14.7	3,600 / 1636	\$ 1030.60 / 7	\$ 3.43
R-K-M006-04-X	1/4" / 6.2 mm	3/4" / 19.5	6,600 / 3000	\$ 1442.01 / 12	\$ 4.81
R-K-M006-05-X	5/16" / 7.9 mm	1" / 24.8	9,500 / 4318	\$ 2132.88 / 18	\$ 7.11
R-K-M006-06-X	3/8" / 9.5 mm	1 1/8" / 29.8	12,000 / 5454	\$ 2863.00 / 24	\$ 9.54
R-K-M006-07-X	7/16" / 11.1 mm	1 1/4" / 34.8	15,000 / 6818	\$ 3391.40 / 30	\$ 11.30
R-K-M013-08-X	1/2" / 12.7 mm	1 1/2" / 39.8	22,000 / 10000	\$ 4931.76 / 47	\$ 16.44
R-K-M013-10-X	5/8" / 15.8 mm	2" / 49.6	36,000 / 16363	\$ 8669.68 / 84	\$ 28.90
R-K-M019-12-X	3/4" / 19.0 mm	9/16" / 59.6	49,000 / 22272	\$ 11559.76 / 116	\$ 38.53
R-K-M019-14-X	7/8" / 22.2 mm	2 3/4" / 69.7	60,000 / 27272	\$ 13811.32 / 142	\$ 46.04
R-K-M025-25-X	1" / 25.4 mm	3" / 79.7	78,000 / 35454	\$ 17409.00 / 184	\$ 58.03

**For the "X" value: "F" for By-The-Foot followed by length in feet (example: F66 = 66 feet)
 use "S" for Spool**

This Product is available By-The-Foot and in Spools. Spools are 600 feet.

Kevlar® Aramid Fiber Shears / Cutters: (See complete list at the end of Section 7)

Kevlar® and aramid based products are difficult to cut due to their filament shear strength. Heavy duty scissors can sometimes cut these materials, but often fail quickly as the Kevlar quickly dulls the cutting edge. Kevlar® Shears are specifically designed to cut Kevlar® and aramid products, and feature a serrated blade so that the fibers don't slip while cutting, holding the fiber in position and allowing for a greater shear force to be applied by the opposing blade. These shears are Extra Heavy Duty, and can be used for other materials such as cutting steel wires and steel tie wraps.

TL-S-KEV-HD-3725 10" length, 4.9" cutting length, Single serrated blade: \$52.00

TL-S-KEV-HD-3925 10" length, 4.9" cutting length, Double serrated blade: \$54.00



Silicone Rubber Cord / Rope - High Temperature & Heat Resistant 400°F / 204°C



- Suitable for continuous operation from -80°F (-62°C) to 400°F (204°C).
- Depending on media and application useful life at temperatures up to 570°F (300°C) may be obtained.
- Stock in 60ShA hardness in red.

Durometer:	60
Tensile Strength, psi (Mpa):	1500 (10.3)
Tear Strength, ppi (N/mm):	120 (21)
Elongation, %:	470
Specific gravity:	1.15
Dielectric Strength, V/mil (kV/mm):	584 (23)
Brittle point, F/C:	-112 (-80)
Compression Set, 22 hrs / 347F/175C. %:	35

FlameShield™ High Temperature, Heat & Flame Resistant Silicone Rubber Cord / Rope

Size: .070" to 0.562" (1.8mm to 14.3mm)

Part Number	Diameter in / mm	Spool Length ft / m	Price per Spool
R-SR-M0018	.070 / 1.8	100 / 30.48	\$ 92.90
R-SR-M0024	.093 / 2.4	100 / 30.48	\$ 96.73
R-SR-M0026	.103 / 2.6	100 / 30.48	\$ 104.21
R-SR-M0032	.125 / 3.2	100 / 30.48	\$ 111.27
R-SR-M0035	.139 / 3.5	100 / 30.48	\$ 118.90
R-SR-M0040	.156 / 4.0	100 / 30.48	\$ 122.73
R-SR-M0048	.188 / 4.8	100 / 30.48	\$ 144.88
R-SR-M0053	.210 / 5.3	100 / 30.48	\$ 152.22
R-SR-M0064	.250 / 6.4	100 / 30.48	\$ 163.26
R-SR-M0070	.275 / 7.0	100 / 30.48	\$ 189.26
R-SR-M0080	.313 / 8.0	100 / 30.48	\$ 204.26
R-SR-M0095	.375 / 9.5	100 / 30.48	\$ 267.26
R-SR-M0110	.437 / 11.0	100 / 30.48	\$ 359.66
R-SR-M0127	.500 / 12.7	100 / 30.48	\$ 391.65
R-SR-M0142	.562 / 14.3	100 / 30.48	\$ 417.31

Other sizes available by quotation

Silicone Sponge Cord - High Temperature & Heat Resistant

392°F / 200°C

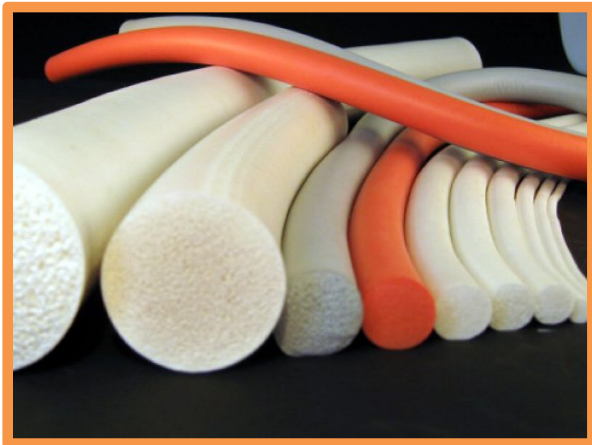

- Suitable for continuous operation from -80°F (-62°C) to 392°F (200°C).
- Depending on media and application useful life at temperatures up to 425°F (218°C) may be obtained.
- Density 16lb per cubic foot
- Compression recovery; 25% deflection: 100% at room temperature. Slightly reduced at elevated temperatures
- Thermal value: 0.0695 W(M.K)
- Tensile strength 65 Newtons

FlameShield™ High Temperature, Heat & Flame Resistant Silicone Sponge Cord

Size: .062" to 1.000" (1.8mm to 14.3mm)

Part Number	Diameter in / mm	Spool Length ft / m	Color	Price per Spool
R-SSC-M0016	.062 / 1.57	50 / 15.24	Blue	\$ 49.50
R-SSC-M0031	.125 / 3.17	50 / 15.24	Black	\$ 57.12
R-SSC-M0047	.187 / 4.74	50 / 15.24	Red	\$ 63.33
R-SSC-M0055	.218 / 5.53	50 / 15.24	Red	\$ 94.48
R-SSC-M0063	.250 / 6.35	50 / 15.24	Grey	\$ 97.37
R-SSC-M0079	.312 / 7.92	50 / 15.24	Blue	\$ 112.54
R-SSC-M0095	.375 / 9.52	50 / 15.24	Red	\$ 183.21
R-SSC-M0110	.437 / 11.09	50 / 15.24	Grey	\$ 216.87
R-SSC-M0127	.500 / 12.70	25 / 7.62	Orange	\$ 135.68
R-SSC-M0158	.625 / 15.87	25 / 7.62	Grey	\$ 180.53
R-SSC-M0190	.750 / 19.05	25 / 7.62	Red	\$ 258.93
R-SSC-M0222	.875 / 22.22	25 / 7.62	Grey	\$ 327.54
R-SSC-M0254	1.000 / 25.40	25 / 7.62	Blue	\$ 394.68



Silicone Rubber Coated Fiberglass Rope
500°F / 260°C Continuous Rating – Higher Temperature for Shorter Periods
High Temperature, Heat & Flame Resistant
Gasket Rope for Liquid / Gas / Steam Containment



FlameShield™ FG-SR rope is an excellent gasket rope for high temperature sealing, especially for liquid or gas containment, steam, etc.

Also an excellent cold temperature rope with flexibility to -76°C for refrigeration and cryogenic applications.

Photo at left shows leftmost 2 rope sections fully coated. The 3rd from left rope section shows partial coating rope style.

Our liquid and paste silicone rubber sealants can be used to seal the joint area for continuous ring gasket applications.

500°F / 260°C continuous rating with higher intermittent capability
 Weld splatter & molten metal splash protection.

FlameShield™ High Temperature Silicone Rubber Coated Fiberglass Rope; Full Coating & Partial Coating								
Part Number	Nominal ID Inches / mm / Dash #			Partial Coat Coil Length ft	Price per coil Partial Coat	Price per 100 ft coil Full Coat	Price per Foot Full Coat	Price per Metre Full Coat
R-FG-SR-M006-04-X-Y	1/4	6	-4	2500	\$ 7325.00	\$ 217.00	\$ 3.97	\$ 13.03
R-FG-SR-M008-05-X-Y	5/16	8	-5	2000	\$ 6900.00	\$ 245.00	\$ 4.47	\$ 14.66
R-FG-SR-M010-06-X-Y	3/8	10	-6	1500	\$ 7155.00	\$ 337.00	\$ 6.17	\$ 20.24
R-FG-SR-M013-08-X-Y	1/2	13	-8	750	\$ 5077.50	\$ 447.00	\$ 8.94	\$ 29.33
R-FG-SR-M016-10-X-Y	5/8	16	-10	500	\$ 4200.00	\$ 550.00	\$ 11.00	\$ 36.09
R-FG-SR-M019-12-X-Y	3/4	19	-12	N/A		\$ 582.00	\$ 11.64	\$ 38.18
R-FG-SR-M022-14-X-Y	7/8	22	-14	N/A		\$ 711.00	\$ 14.22	\$ 46.64
R-FG-SR-M025-16-X-Y	1	25	-16	N/A		\$ 820.00	\$ 16.40	\$ 53.79
R-FG-SR-M032-20-X-Y	1 1/4	32	-20	N/A		\$ 1125.00	\$ 22.50	\$ 73.80

For the "X" value; Replace with "FC" for Full Coating, and "PC" for Partial Coating

For the "Y" value; Replace with "100" for full coil, and "ZZ" for by the foot, where ZZ = length in feet

Standard coil length for full coating rope is 100 feet / 30 Metres.
Partial Coat rope only available in full coil length.

High temperature rope, typically used as a gasket, providing a high-temperature seal that provides a higher degree of liquid or gas containment compared to a plain tape or rope gasket. The rope can be partially or completely coated (partially coated rope allows for gluing or other methods of fastening). This rope can also be fabricated into a closed ring and is ideal for many gasket and sealing applications on boilers and similar industrial appliances.



Acrylic Fiber with PTFE Impregnation Square Braided Gasket Rope 500°F / 260°C: High Temperature Heat & Chemical Resistance



- Economical alternative to Asbestos
- Acrylic synthetic fiber with PTFE Impregnation
- pH: 2 to 12
- Up to 3000 psi
- Shaft speed up to 2500 feet per minute

This rope offers the advantage of a non-asbestos material with higher temperature range and with excellent resistance to almost all solvents, caustics and acids.

Used as a pump packing and stuffing box packing

High Temperature & Chemical Resistance Acrylic Fiber with PTFE Impregnation Square Braid Rope				
Part Number	OD Size inch / mm	Feet per Spool	Feet per Pound	Price per Pound
R-A-PT-SQ-M003-02	0.125 / 3	500	100	\$ 35.75
R-A-PT-SQ-M005-03	0.187 / 5	225	45	\$ 35.75
R-A-PT-SQ-M006-04	0.250 / 6	100	25	\$ 35.75
R-A-PT-SQ-M008-05	0.312 / 8	85	17	\$ 35.75
R-A-PT-SQ-M010-06	0.375 / 10	60	12	\$ 35.75
R-A-PT-SQ-M011-07	0.437 / 11	45	9	\$ 35.75
R-A-PT-SQ-M013-08	0.500 / 13	35	7	\$ 35.75
R-A-PT-SQ-M014-09	0.562 / 14	55	5.5	\$ 35.75
R-A-PT-SQ-M016-10	0.625 / 16	45	4.5	\$ 35.75
R-A-PT-SQ-M019-12	0.750 / 19	31	3.1	\$ 35.75
R-A-PT-SQ-M022-14	0.875 / 22	23	2.3	\$ 35.75

This product is sold in a minimum 5 pound spool, and additionally in 1 pound increments



Pure PTFE Square Braided Gasket & Packing Seal Rope
550°F / 287°C: High Temperature Heat & Chemical Resistance



- Pure PTFE
- pH: 0 to 14
- Up to 2500 psi
- Shaft speed up to 1600 feet per minute
- Use in corrosive and “clean” applications

This pure PTFE square rope offers the advantage of a non-asbestos material with high temperature range and with excellent resistance to almost all solvents, caustics and acids.

PTFE melting point is 620°F / 327°C. Used as a pump packing and stuffing box packing

Pure PTFE Square Braid Rope High Temperature & Chemical Resistance				
Part Number	OD Size inch / mm	Feet per Spool	Feet per Pound	Price per Pound
R-PTFE-SQ-M003-02	0.125 / 3	415	83	\$ 58.44
R-PTFE-SQ-M005-03	0.187 / 5	180	36	\$ 58.44
R-PTFE-SQ-M006-04	0.250 / 6	102	20.4	\$ 58.44
R-PTFE-SQ-M008-05	0.312 / 8	68	13.6	\$ 58.44
R-PTFE-SQ-M010-06	0.375 / 10	46	9.3	\$ 58.44
R-PTFE-SQ-M011-07	0.437 / 11	34	6.9	\$ 58.44
R-PTFE-SQ-M013-08	0.500 / 13	26	5.3	\$ 58.44
R-PTFE-SQ-M014-09	0.562 / 14	42	4.2	\$ 58.44
R-PTFE-SQ-M016-10	0.625 / 16	35	3.5	\$ 58.44
R-PTFE-SQ-M019-12	0.750 / 19	23	2.36	\$ 58.44
R-PTFE-SQ-M022-14	0.875 / 22	17	1.76	\$ 58.44

THIS PRODUCT IS SOLD IN ONE POUND INCREMENTS



Knitted Fiberglass Rope with PTFE Coating - High Temperature Heat & Chemical Resistance

550°F / 287°C: *Round Soft Rope*



- PTFE sintered impregnation

This rope offers the advantage of a non-asbestos material with high temperature range and with excellent resistance to almost all solvents, caustics and acids.

The base yarn is rated to 1200°F / 648°C.

PTFE melting point is 620°F / 327°C.

Used as a pump packing and stuffing box packing

High Temperature & Chemical Resistance Knitted Fiberglass Rope with PTFE Coating: <i>Round Soft Rope</i>			
Part Number	OD Size inch / mm	Feet per Spool	Price per foot / meter
R-FG-PT-KS-M002-01	0.062 / 1.6	2,500	\$ 1.20 / \$ 3.94
R-FG-PT-KS-M003-02	0.125 / 3	1,500	\$ 1.23 / \$ 4.04
R-FG-PT-KS-M005-03	0.187 / 5	2,100	\$ 1.25 / \$ 4.10
R-FG-PT-KS-M006-04	0.250 / 6	1,300	\$ 1.27 / \$ 4.17
R-FG-PT-KS-M010-06	0.375 / 10	750	\$ 1.36 / \$ 4.46
R-FG-PT-KS-M013-08	0.500 / 13	500	\$ 2.56 / \$ 8.40
R-FG-PT-KS-M016-10	0.625 / 16	300	\$ 2.98 / \$ 9.78
R-FG-PT-KS-M019-12	0.750 / 19	200	\$ 4.72 / \$ 15.49
R-FG-PT-KS-M022-14	0.875 / 22	150	\$ 5.28 / \$ 17.32
R-FG-PT-KS-M025-16	1.000 / 25	125	\$ 8.44 / \$ 27.69
R-FG-PT-KS-M032-20*	1.250 / 32	85	\$ 8.63 / \$ 28.31
R-FG-PT-KS-M038-24*	1.500 / 38	55	\$ 10.57 / \$ 34.68

This Product is Available By-The-Foot Except Where Indicated

*These items are sold in full length spools only.

The PTFE is applied to the rope by a proprietary sinterization process. The rope is soaked repeatedly in a PTFE dispersion, dried, and then baked. The result is a PTFE coating on the rope which is soft, robust and flexible; however, it can be abrasively removed from the rope with aggressive fingernail scraping, resulting in a thinner and thinner layer of ptfе remaining with each pass. The PTFE also causes the yarns to be sealed and the small gaps between the yarns filled, resulting in an almost air-tight / liquid-tight rope.



Fiberglass Knitted Round Rope with PTFE Coating

550°F / 287°C: High Temperature Heat & Chemical Resistance Knitted Round Dense Rope



- PTFE Impregnation

This rope offers the advantage of a non-asbestos material with higher temperature range and with excellent resistance to almost all solvents, caustics and acids.

The base yarn is rated to 1200°F / 648°C.

PTFE melting point is 620°F / 327°C.

550°F / 287°C continuous rating, high insulation value

Used as a pump packing and stuffing box packing

Very High Temperature Knitted Fiberglass Rope with PTFE Coating: *Round Dense Rope*

Part Number	OD Size inch / mm	Feet per Spool	Price per foot
R-FG-PT-KD-M003-02	0.125 / 3	1,500	\$ 0.84
R-FG-PT-KD-M005-03	0.187 / 5	1,750	\$ 0.96
R-FG-PT-KD-M006-04	0.250 / 6	1,100	\$ 1.08
R-FG-PT-KD-M010-06	0.375 / 10	600	\$ 1.52
R-FG-PT-KD-M013-08	0.500 / 13	400	\$ 2.88
R-FG-PT-KD-M016-10	0.625 / 16	260	\$ 3.32
R-FG-PT-KD-M019-12	0.750 / 19	160	\$ 5.24
R-FG-PT-KD-M022-14	0.875 / 22	120	\$ 5.92
R-FG-PT-KD-M025-16	1.000 / 25	100	\$ 9.36
<i>R-FG-PT-KD-M032-20*</i>	1.250 / 32	70	\$ 9.60
<i>R-FG-PT-KD-M038-24*</i>	1.500 / 38	55	\$ 11.70
<i>R-FG-PT-KD-M051-32*</i>	2.000 / 51	50	\$ 48.77
<i>R-FG-PT-KD-M064-40*</i>	2.500 / 64	100	\$ 66.76
<i>R-FG-PT-KD-M076-48*</i>	3.000 / 76	100	\$ 84.30
<i>R-FG-PT-KD-M102-64*</i>	4.000 / 102	100	\$ 175.37

This Product is Available By-The-Foot Except Where Indicated

*These items are sold in full length spools only.

The PTFE is applied to the rope by a proprietary sinterization process. The rope is soaked repeatedly in a PTFE dispersion, dried, and then baked. The result is a PTFE coating on the rope which is soft, robust and flexible; however, it can be abrasively removed from the rope with aggressive fingernail scraping, resulting in a thinner and thinner layer of ptfе remaining with each pass. The PTFE also causes the yarns to be sealed and the small gaps between the yarns filled, resulting in an almost air-tight / liquid-tight rope.



Round Twisted Fiberglass Rope with PTFE Coating 550°F / 287°C: High Temperature Heat & Chemical Resistance



- PTFE Impregnation

This rope offers the advantage of a non-asbestos material with higher temperature range and with excellent resistance to almost all solvents, caustics and acids.

The base yarn is rated to 1200°F / 648°C.

PTFE melting point is 620°F / 327°C.

Used as a pump packing and stuffing box packing

High Temperature Heat & Chemical Resistance Fiberglass Round Twisted Rope with PTFE Coating			
Part Number	OD Size inch / mm	Feet per Spool	Price per foot
R-FG-PT-T-M003-02	0.125 / 3	2,525	\$ 0.99
R-FG-PT-T-M006-04	0.250 / 6	1,275	\$ 1.36
R-FG-PT-T-M010-06	0.375 / 10	969	\$ 2.56
R-FG-PT-T-M013-08	0.500 / 13	523	\$ 3.24
R-FG-PT-T-M016-10	0.625 / 16	305	\$ 5.20
R-FG-PT-T-M019-12	0.750 / 19	168	\$ 9.52
R-FG-PT-T-M022-14	0.875 / 22	144	\$ 11.04
R-FG-PT-T-M025-16	1.000 / 25	114	\$ 13.92
<i>R-FG-PT-T-M032-20*</i>	1.250 / 32	77	\$ 18.43
<i>R-FG-PT-T-M038-24*</i>	1.500 / 38	50	\$ 36.67
<i>R-FG-PT-T-M051-28*</i>	2.000 / 51	27	\$ 78.60

This Product is Available By-The-Foot Except Where Indicated

*These items are sold in full length spools only.

The PTFE is applied to the rope by a proprietary sinterization process. The rope is soaked repeatedly in a PTFE dispersion, dried, and then baked. The result is a PTFE coating on the rope which is soft, robust and flexible; however, it can be abrasively removed from the rope with aggressive fingernail scraping, resulting in a thinner and thinner layer of ptfе remaining with each pass. The PTFE also causes the yarns to be sealed and the small gaps between the yarns filled, resulting in an almost air-tight / liquid-tight rope.



Square Braided Fiberglass Rope with PTFE Impregnation 550°F / 287°C: High Temperature Heat & Chemical Resistance



- PTFE Impregnation

This rope offers the advantage of a non-asbestos material with higher temperature range and with excellent resistance to almost all solvents, caustics and acids.

The base yarn is rated to 1200°F / 648°C.

PTFE melting point is 620°F / 327°C.

Used as a pump packing and stuffing box packing

High Temperature & Chemical Resistance Fiberglass Square Braided Rope with PTFE Coating			
Part Number	OD Size inch / mm	Feet per Spool	Price per foot
R-FG-PT-SQ-M006-04	0.250 / 6	375	\$ 5.60
R-FG-PT-SQ-M008-05	0.312 / 8	315	\$ 4.90
R-FG-PT-SQ-M010-06	0.375 / 10	285	\$ 5.07
R-FG-PT-SQ-M011-07	0.437 / 11	212	\$ 6.80
R-FG-PT-SQ-M013-08	0.500 / 13	162	\$ 8.90
R-FG-PT-SQ-M014-09	0.562 / 14	127	\$ 11.33
R-FG-PT-SQ-M016-10	0.625 / 16	105	\$ 13.70
R-FG-PT-SQ-M019-12	0.750 / 19	75	\$ 19.20
R-FG-PT-SQ-M022-14	0.875 / 22	55	\$ 26.17
R-FG-PT-SQ-M025-16	1.000 / 25	45	\$ 31.98
R-FG-PT-SQ-M032-20*	1.250 / 32	26	\$ 46.17
R-FG-PT-SQ-M038-24*	1.500 / 38	18	\$ 66.60
R-FG-PT-SQ-M051-32*	2.000 / 51	11	\$ 109.10

This Product is Available By-The-Foot Except Where Indicated

*These items are sold in full length spools only.

The PTFE is applied to the rope by a proprietary sinterization process. The rope is soaked repeatedly in a PTFE dispersion, dried, and then baked. The result is a PTFE coating on the rope which is soft, robust and flexible; however, it can be abrasively removed from the rope with aggressive fingernail scraping, resulting in a thinner and thinner layer of ptf remaining with each pass. The PTFE also causes the yarns to be sealed and the small gaps between the yarns filled, resulting in an almost air-tight / liquid-tight rope.



Square Braided PTFE Rope with Graphite Coating
550°F / 287°C: PT-Graf™ High Temperature & Chemical Resistant



- Graphite Impregnated PTFE yarn
- Heat Resistant / Chemical Resistant
- Conformable and Resilient
- Thermally Conductive
- Self Lubricating
- pH range: 0 to 14
- 4000 psi
- Up to 4500 FPM shaft speed
- Unique packing rope with best of both world's sealing performance where moderate temperature resistance is needed.

Used as a compression packing for pump and valve shafts and as a stuffing box packing.

High Temperature Square Braided PT-Graf™ Graphite Coated PTFE Rope				
Part Number	OD Size inch / mm	Feet per Spool	Feet per Pound	Price per Pound
R-PTGR-SQ-M003-02	0.125 / 3	520	104	\$ 59.88
R-PTGR-SQ-M005-03	0.187 / 5	230	46	\$ 59.88
R-PTGR-SQ-M006-04	0.250 / 6	135	27	\$ 59.88
R-PTGR-SQ-M008-05	0.312 / 8	85	17	\$ 59.88
R-PTGR-SQ-M010-06	0.375 / 10	60	12	\$ 59.88
R-PTGR-SQ-M011-07	0.437 / 11	45	9	\$ 59.88
R-PTGR-SQ-M013-08	0.500 / 13	34	6.8	\$ 59.88
R-PTGR-SQ-M014-09	0.562 / 14	54	5.4	\$ 59.88
R-PTGR-SQ-M016-10	0.625 / 16	44	4.4	\$ 59.88
R-PTGR-SQ-M019-12	0.750 / 19	32	3.2	\$ 59.88
R-PTGR-SQ-M022-14	0.875 / 22	23	2.3	\$ 59.88

This Product is Available By-The-Foot

THIS PRODUCT IS SOLD IN ONE POUND INCREMENTS



Fiberglass Knitted Rope, Premium Grade: *Soft Rope*
1200°F / 648°C: Very High Temperature & Heat Resistant



This knitted rope is fabricated from high quality type E fiberglass that will not burn and will withstand continuous exposure to temperatures of 1200°F / 648°C.

This material resists most acids and alkalis and is unaffected by most bleaches and solvents. It is highly flexible and conformable.

The base fiber is manufactured to the specifications of ASTM D-578, ASTM committee D13, and subcommittee D13.18.

Meets US Coast Guard specification 164.009 for incombustible material.

A Heat Treated version of this product is available – please enquire

1200°F / 648°C continuous rating, high insulation value & excellent personnel protection

Very High Temperature & Heat Resistant Fiberglass Knitted Rope Premium Grade: <i>Soft Rope</i>			
Part Number	OD Size inch / mm / dash#	Feet / Metres per Carton	Price per Carton
R-FG-KS-P-M002-01	0.062 / 1.6 / 01	2,500 / 762	\$ 750.00
R-FG-KS-P-M003-02	0.125 / 3 / -02	1,500 / 457	\$ 345.00
R-FG-KS-P-M005-03	0.187 / 5 / -03	2,500 / 762	\$ 675.00
R-FG-KS-P-M006-04	0.250 / 6 / -04	2,000 / 609	\$ 600.00
R-FG-KS-P-M008-05	0.312 / 8 / -05	1,500 / 457	\$ 645.00
R-FG-KS-P-M010-06	0.375 / 10 / -06	1,000 / 304	\$ 530.00
R-FG-KS-P-M011-07	0.437 / 11 / -07	750 / 228	\$ 502.50
R-FG-KS-P-M013-08	0.500 / 13 / -08	500 / 152	\$ 415.00
R-FG-KS-P-M016-10	0.625 / 16 / -10	450 / 137	\$ 436.50
R-FG-KS-P-M019-12	0.750 / 19 / -12	500 / 152	\$ 650.00
R-FG-KS-P-M022-14	0.875 / 22 / -14	300 / 91	\$ 669.00
R-FG-KS-P-M025-16	1.000 / 25 / -16	250 / 76	\$ 657.50
R-FG-KS-P-M032-20	1.250 / 32 / -20	175 / 38	\$ 862.75
R-FG-KS-P-M038-24	1.500 / 38 / -24	150 / 45	\$ 865.50
R-FG-KS-P-M044-28	1.750 / 44 / -28	90 / 27	\$ 740.70

Please call for additional discount pricing when ordering more than 6 cartons.

Knitted Fiberglass Rope is used extensively as a seal in ovens and kiln access doors, and also as a high-temperature packing.

This Product is NOT Available By-The-Foot – Full Carton Only

Additional Technical Specifications: Breaking Tenacity: 1.71 gf/TEX Std and Wet. Tensile Strength: 450,000-500,000 psi. Breaking Elongation: 4.81% Std and Wet. Elastic Recovery: 100% Average Stiffness: 2824.3 cn/TEX. Specific Gravity: 2.54 – 2.69. 75% tensile at 343°C. Softens 732 – 877°C. Melts 1121-1182°C.



Fiberglass Knitted Rope, Premium Grade: *Dense Rope*
1200°F / 648°C: Very High Temperature & Heat Resistant



This knitted rope is fabricated from high quality type E fiberglass that will not burn and will withstand continuous exposure to temperatures of 1200°F / 648°C.

This material resists most acids and alkalis and is unaffected by most bleaches and solvents. It is highly flexible and conformable.

The base fiber is manufactured to the specifications of ASTM D-578, ASTM committee D13, and subcommittee D13.18.

Meets US Coast Guard specification 164.009 for incombustible material.

A Heat Treated version of this product is available – please enquire

Very High Temperature & Heat Resistant Fiberglass Knitted Rope Premium Grade: <i>Dense Rope</i>			
Part Number	OD Size inch / mm / dash#	Feet / Metres per Carton	Price per Carton
R-FG-KD-P-M003-02	0.125 / 3 / -02	1,500 / 457	\$ 450.00
R-FG-KD-P-M005-03	0.187 / 5 / -03	2,500 / 762	\$ 825.00
R-FG-KD-P-M006-04	0.250 / 6 / -04	1,500 / 457	\$ 600.00
R-FG-KD-P-M008-05	0.312 / 8 / -05	1,000 / 304	\$ 530.00
R-FG-KD-P-M010-06	0.375 / 10 / -06	700 / 213	\$ 511.00
R-FG-KD-P-M011-07	0.437 / 11 / -07	600 / 182	\$ 540.00
R-FG-KD-P-M013-08	0.500 / 13 / -08	450 / 137	\$ 585.00
R-FG-KD-P-M016-10	0.625 / 16 / -10	300 / 91	\$ 489.00
R-FG-KD-P-M019-12	0.750 / 19 / -12	350 / 106	\$ 665.00
R-FG-KD-P-M022-14	0.875 / 22 / -14	225 / 68	\$ 630.00
R-FG-KD-P-M025-16	1.000 / 25 / -16	200 / 60	\$ 686.00
R-FG-KD-P-M032-20	1.250 / 32 / -20	125 / 38	\$ 837.50
R-FG-KD-P-M038-24	1.500 / 38 / -24	100 / 30	\$ 903.00
R-FG-KD-P-M044-28	1.750 / 44 / -28	80 / 24	\$ 797.60

Please call for additional discount pricing when ordering more than 6 cartons.

Knitted Fiberglass Rope is used extensively as a seal in ovens and kiln access doors, and also as a high-temperature packing.

This Product is NOT Available By-The-Foot – Full Carton Only

Additional Technical Specifications: Breaking Tenacity: 1.71 gf/TEX Std and Wet. Tensile Strength: 450,000-500,000 psi. Breaking Elongation: 4.81% Std and Wet. Elastic Recovery: 100% Average Stiffness: 2824.3 cn/TEX. Specific Gravity: 2.54 – 2.69. 75% tensile at 343°C. Softens 732 – 877°C. Melts 1121-1182°C.



Fiberglass Knitted Rope, Industrial Grade: *Soft Rope* 1200°F / 648°C: Very High Temperature & Heat Resistant



This knitted rope is fabricated from high quality type E fiberglass that will not burn and will withstand continuous exposure to temperatures of 1200°F / 648°C.

This material resists most acids and alkalis and is unaffected by most bleaches and solvents. It is highly flexible and conformable.

Commonly used for making gaskets on a variety of industrial and commercial boilers, ovens, furnaces. Used as a high temperature packing for shaft seals. Also used for residential wood and pellet stoves.

Other applications include a general purpose rope for industrial use, to suspend or hang objects or tie-off in high temperature environments in steel mills, aluminum and metals processing plants, etc.

A Heat Treated version of this product is available – please enquire

Meets US Coast Guard specification 164.009 for incombustible material.

1200°F / 648°C continuous rating, high insulation value & excellent personnel protection

Very High Temperature & Heat Resistant Fiberglass Knitted Rope Industrial Grade: <i>Soft Rope</i>			
Part Number	OD Size inch / mm	Feet / Metres per Spool	Price per Foot / Metre
<i>R-FG-KS-I-M002-01*</i>	0.062 / 1.6	2,500 / 762	\$ 0.36 / \$ 1.18
<i>R-FG-KS-I-M003-02</i>	0.125 / 3	1,500 / 457	\$ 0.28 / \$ 0.92
<i>R-FG-KS-I-M005-03</i>	0.187 / 5	2,100 / 640	\$ 0.29 / \$ 0.95
<i>R-FG-KS-I-M006-04</i>	0.250 / 6	1,300 / 396	\$ 0.32 / \$ 1.05
<i>R-FG-KS-I-M010-06</i>	0.375 / 10	750 / 228	\$ 0.56 / \$ 1.84
<i>R-FG-KS-I-M013-08</i>	0.500 / 13	500 / 152	\$ 1.04 / \$ 3.41
<i>R-FG-KS-I-M016-10</i>	0.625 / 16	300 / 91	\$ 1.12 / \$ 3.67
<i>R-FG-KS-I-M019-12</i>	0.750 / 19	200 / 60	\$ 1.64 / \$ 5.38
<i>R-FG-KS-I-M022-14</i>	0.875 / 22	150 / 45	\$ 2.40 / \$ 7.87
<i>R-FG-KS-I-M025-16</i>	1.000 / 25	125 / 38	\$ 3.32 / \$ 10.89
<i>R-FG-KS-I-M032-20*</i>	1.250 / 32	85 / 25	\$ 3.40 / \$ 11.15
<i>R-FG-KS-I-M038-24*</i>	1.500 / 38	55 / 16	\$ 4.20 / \$ 13.77

This product is not to be used for life safety applications

This Product is Available By-The-Foot / Metre Except Where Indicated

*These items are sold in full length spools only.

Additional Technical Specifications: Breaking Tenacity: 1.71 gf/TEX Std and Wet. Tensile Strength: 450,000-500,000 psi. Breaking Elongation: 4.81% Std and Wet. Elastic Recovery: 100% Average Stiffness: 2824.3 cn/TEX. Specific Gravity: 2.54 – 2.69. 75% tensile at 343°C. Softens 732 – 877°C. Melts 1121-1182°C.

Fiberglass Knitted Rope, Industrial Grade: *Dense Rope* 1200°F / 648°C: Very High Temperature & Heat Resistant



This knitted rope is fabricated from high quality type E fiberglass that will not burn and will withstand continuous exposure to temperatures of 1200°F / 648°C.

This material resists most acids and alkalis and is unaffected by most bleaches and solvents. It is highly flexible and conformable.

Commonly used for making gaskets on a variety of industrial and commercial boilers, ovens, furnaces. Used as a high temperature packing for shaft seals. Also used for residential wood and pellet stoves.

Other applications include a general purpose rope for industrial use, to suspend or hang objects or tie-off in high temperature environments in steel mills, aluminum and metals processing plants, etc.

A Heat Treated version of this product is available – please enquire

Meets US Coast Guard specification 164.009 for incombustible material.

1200°F / 648°C continuous rating, high insulation value & excellent personnel protection

Very High Temperature & Heat Resistant Fiberglass Knitted Rope Industrial Grade: <i>Dense Rope</i>			
Part Number	OD Size inch / mm / dash#	Feet / Metres per Spool	Price per Foot / Metre
R-FG-KD-I-M003-02	0.125 / 3 / -02	1,500 / 457	\$ 0.36 / \$ 1.18
R-FG-KD-I-M005-03	0.187 / 5 / -03	1,750 / 533	\$ 0.24 / \$ 0.79
R-FG-KD-I-M006-04	0.250 / 6 / -04	1,100 / 335	\$ 0.28 / \$ 0.92
R-FG-KD-I-M010-06	0.375 / 10 / -06	600 / 182	\$ 0.52 / \$ 1.71
R-FG-KD-I-M013-08	0.500 / 13 / -08	400 / 121	\$ 0.96 / \$ 3.15
R-FG-KD-I-M016-10	0.625 / 16 / -10	260 / 79	\$ 1.04 / \$ 3.41
R-FG-KD-I-M019-12	0.750 / 19 / -12	160 / 48	\$ 1.56 / \$ 5.12
R-FG-KD-I-M022-14	0.875 / 22 / -14	120 / 36	\$ 2.20 / \$ 7.22
R-FG-KD-I-M025-16	1.000 / 25 / -16	100 / 30	\$ 3.16 / \$ 10.36
<i>R-FG-KD-I-M032-20 *</i>	1.250 / 32 / -20	70 / 21	Full Spool \$ 261.10
<i>R-FG-KD-I-M038-24 *</i>	1.500 / 38 / -24	55 / 16	Full Spool \$ 311.85
<i>R-FG-KD-I-M051-32 *</i>	2.000 / 51 / -32	50 / 15	Full Spool \$ 685.00
<i>R-FG-KD-I-M064-40 *</i>	2.500 / 64 / -40	100 / 30	Full Spool \$ 1980.00
<i>R-FG-KD-I-M076-48 *</i>	3.000 / 76 / -48	100 / 30	Full Spool \$ 2960.00
<i>R-FG-KD-I-M102-64 *</i>	4.000 / 102 / -64	100 / 30	Full Spool \$ 4750.00

This product is not to be used for life safety applications

This Product is Available By-The-Foot / Metre Except Where Indicated

* These items are sold in full length spools only.

Additional Technical Specifications: Breaking Tenacity: 1.71 gf/TEX Std and Wet. Tensile Strength: 450,000-500,000 psi. Breaking Elongation: 4.81% Std and Wet. Elastic Recovery: 100% Average Stiffness: 2824.3 cn/TEX. Specific Gravity: 2.54 – 2.69. 75% tensile at 343°C. Softens 732 – 877°C. Melts 1121-1182°C.



Fiberglass Twisted Rope: Premium Grade
1200°F / 648°C: Very High Temperature & Heat Resistant



This high temperature and heat resistant knitted rope is fabricated from high quality type E fiberglass that will not burn and will withstand continuous exposure to temperatures of 1200°F / 648°C.

This material resists most acids and alkalis and is unaffected by most bleaches and solvents. It is highly flexible and conformable.

Meets US Coast Guard specification 164.009 for incombustible material.

A Heat Treated version of this product is available – please enquire

1200°F / 648°C continuous rating, high insulation value & excellent personnel protection

Very High Temperature & Heat Resistant Fiberglass Twisted Rope Premium Grade			
Part Number	OD Size inch / mm	Feet / Metres per Spool	Price per Foot / Metre
R-FG-T-M003-02	0.125 / 3 / -02	2,525 / 769	\$ 0.24 / \$ 0.79
R-FG-T-M006-04	0.250 / 6 / -04	1,275 / 388	\$ 0.44 / \$ 1.44
R-FG-T-M010-06	0.375 / 10 / -06	969 / 295	\$ 0.52 / \$ 1.71
R-FG-T-M013-08	0.500 / 13 / -08	523 / 159	\$ 1.04 / \$ 3.41
R-FG-T-M016-10	0.625 / 16 / -10	305 / 92	\$ 1.40 / \$ 4.59
R-FG-T-M019-12	0.750 / 19 / -12	168 / 51	\$ 3.08 / \$ 10.10
R-FG-T-M022-14	0.875 / 22 / -14	144 / 43	\$ 3.60 / \$ 11.81
R-FG-T-M025-16	1.000 / 25 / -16	114 / 34	\$ 4.40 / \$ 14.43
R-FG-T-M032-20 *	1.250 / 32 / -20	50 / 15	Full Spool \$ 387.88
R-FG-T-M038-24 *	1.500 / 38 / -24	50 / 15	Full Spool \$ 625.00
R-FG-T-M051-32 *	2.000 / 51 / -32	27 / 8	Full Spool \$ 803.79

This Product is Available By-The-Foot Except Where Indicated

* These items are sold in full length spools only.

Additional Technical Specifications: Breaking Tenacity: 1.71 gf/TEX Std and Wet. Tensile Strength: 450,000-500,000 psi. Breaking Elongation: 4.81% Std and Wet. Elastic Recovery: 100% Average Stiffness: 2824.3 cn/TEX. Specific Gravity: 2.54 – 2.69. 75% tensile at 343°C. Softens 732 – 877°C. Melts 1121-1182°C.



**Fiberglass Braided Square Rope: Premium Grade
 (Square Dry Packing Rope)
 1200°F / 648°C: Very High Temperature & Heat Resistant**



This knitted rope is fabricated from high quality type E fiberglass that will not burn and will withstand continuous exposure to temperatures of 1200°F / 648°C.

This material resists most acids and alkalis and is unaffected by most bleaches and solvents. It is highly flexible and conformable.

Braided square rope is often used as a square dry packing.

A Heat Treated version of this product is available – please enquire

Very High Temperature & Heat Resistant Fiberglass Braided Square Rope - Premium Grade				
Part Number	OD Size inch / mm	Feet / Metres per Spool Large Spool / Std Spool		Price per Foot / Metre
R-FG-SQ-M006-04-X	0.250 / 6 / -04	375 / 114	650 / 198	\$ 1.60 / \$ 5.25
R-FG-SQ-M008-05	0.312 / 8 / -05	315 / 96	N/A	\$ 1.87 / \$ 6.13
R-FG-SQ-M010-06-X	0.375 / 10 / -06	285 / 86	370 / 112	\$ 2.10 / \$ 6.89
R-FG-SQ-M011-07	0.437 / 11 / -07	212 / 64	N/A	\$ 2.80 / \$ 9.18
R-FG-SQ-M013-08-X	0.500 / 13 / -08	162 / 49	220 / 67	\$ 3.67 / \$ 12.04
R-FG-SQ-M014-09	0.562 / 14 / -09	127 / 38	N/A	\$ 4.70 / \$ 15.42
R-FG-SQ-M016-10-X	0.625 / 16 / -10	105 / 32	160 / 48	\$ 5.67 / \$ 18.60
R-FG-SQ-M019-12-X	0.750 / 19 / -12	75 / 22.8	110 / 33	\$ 7.93 / \$ 26.01
R-FG-SQ-M022-14-X	0.875 / 22 / -14	55 / 16.7	88 / 26	\$ 10.83 / \$35.52
R-FG-SQ-M025-16-X	1.000 / 25 / -16	45 / 13.7	70 / 21	\$ 13.23 / \$ 43.39
R-FG-SQ-M032-20 *	1.250 / 32 / -20	26 / 7.9	N/A	Full Spool \$ 496.60
R-FG-SQ-M038-24-X *	1.500 / 38 / -24	18 / 5.4	30 / 9	Full Spool \$ 496.80
R-FG-SQ-M051-32-X *	2.000 / 51 / -32	11 / 3.3	17 / 5	Full Spool \$ 496.43

For the "X" value: Use "L" for Large Spool and "S" for Standard Spool

This Product is Available By-The-Foot Except Where Indicated

* These items are sold in full length spools only.

Additional Technical Specifications: Breaking Tenacity: 1.71 gf/TEX Std and Wet. Tensile Strength: 450,000-500,000 psi. Breaking Elongation: 4.81% Std and Wet. Elastic Recovery: 100% Average Stiffness: 2824.3 cn/TEX. Specific Gravity: 2.54 – 2.69. 75% tensile at 343°C/649°F. Softens 732 – 877°C/1349°F-1610°F. Melts 1121-1182°C/2049°F-2159°F.



Kevlar Overbraided Fiberglass Rope
320°F / 160°C: Very High Temperature & Heat Resistant



- This rope's core can be either soft or dense knitted fiberglass round rope.
- Overbraided with genuine Kevlar.
- Cut and wear resistant – results in a long lasting seal for high cycle access doors.
- Cost savings over a 100% Kevlar rope.

320°F / 160°C continuous rating, high insulation value & excellent personnel protection

Kevlar Overbraided Fiberglass Rope High Temperature & Heat Resistant			
Part Number	OD Size inch / mm / dash#	Feet / Metres per Spool	Price per Carton
R-FG-KOVB-M006-04	0.250 / 6 / -04	1500 /	\$ On Request
R-FG-KOVB-M010-06	0.375 / 10 / -06	700 /	\$ On Request
R-FG-KOVB-M013-08	0.500 / 13 / -08	500 /	\$ On Request
R-FG-KOVB-M016-10	0.625 / 16 / -10	300 /	\$ On Request
R-FG-KOVB-M019-12	0.750 / 19 / -12	300 /	\$ On Request
R-FG-KOVB-M022-14	0.875 / 22 / -14	200 /	\$ On Request
R-FG-KOVB-M025-16	1.000 / 25 / -16	200 /	\$ On Request
R-FG-KOVB-M032-20	1.250 / 32 / -20	125 /	\$ On Request
R-FG-KOVB-M038-24	1.500 / 38 / -24	100 /	\$ On Request
R-FG-KOVB-M044-28	1.750 / 44 / -28	90 /	\$ On Request
R-FG-KOVB-M051-32	2.000 / 51 / -32	50 /	\$ On Request

This product is available full carton only



Fiberglass Gasket Rope – Hollow Metal Core – with Clip Mounting

1200°F / 648°C: Very High Temperature & Heat Resistant Fiberglass Gasket Rope

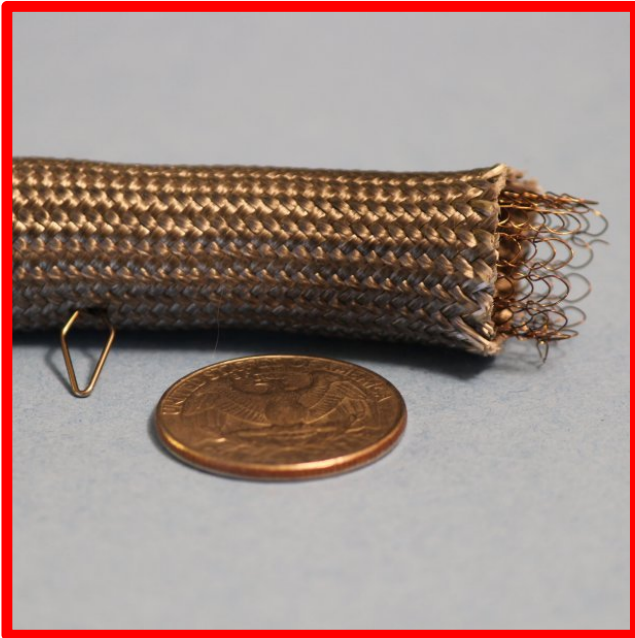

- The two sizes of this rope gasket is constructed of a heat treated fiberglass braid sleeve with a 304 stainless steel knitted mesh hollow sleeve core, with a stainless steel mounting clip spaced every 3 inches.
- Provides excellent compression and pushback, with high cycle life.
- The braid is a high quality type E fiberglass filament yarn that will not burn and will withstand continuous exposure to temperatures of 1200°F / 648°C.
- This material resists most acids and alkalis and is unaffected by most bleaches and solvents. It is highly flexible and conformable.
- Heat treated to result in an extremely clean surface that sheds extremely few fibers and no organic odors. Suitable for most clean room, paint booth and food service applications.
- This gasket is commonly used on consumer self-cleaning ovens as a door seal.

For applications such as commercial, industrial and scientific ovens and dryers, this gasket rope is easily installed by drilling a 1/8 inch hole into the door or frame on the equipment, and then inserting the self expanding clip into the hole. Maximum mounting material thickness is 1/16 inch. Spacing between clips is 3" (7.6cm). Clip length is .42" with no clip compression. Undesired clips can be partially removed by cutting the protruding portion of the clip with wire cutters. .57 rope has an ultimate compression to .110" without damage. Optimum compression range is from .15" to .40". .42 rope has an ultimate compression to .110" without damage. Optimum compression range is from .15" to .23".

The .57 rope ID of the hollow knit metal sleeve core is 1/2 inch. Weighs 0.70 oz per foot / 65 g per meter.
 The .42 rope ID of the hollow knit metal sleeve core is 3/8 inch. Weighs 0.53 oz per foot / 49 g per meter.

Very High Temperature & Heat Resistant Heat Treated Fiberglass Braided Rope Gasket with Stainless Steel Knit Hollow Core			
Part Number	OD Size inch / mm	Feet / Metres per coil	Price per coil / Foot
R-FG-MC-CLIP-0.570-M0144-025	0.57 / 14.4	25 / 7.6	\$ 187.23 / coil
R-FG-MC-CLIP-0.570-M0144-050	0.57 / 14.4	50 / 15.2	\$ 354.47 / coil
R-FG-MC-CLIP-0.570-M0144-250	0.57 / 14.4	250 / 76.2	\$ 1427.50 / coil
R-FG-MC-CLIP-0.570-M0144-FT	0.57 / 14.4	By The Foot	\$ 8.36 / foot
R-FG-MC-CLIP-0.420-M0107-025	0.42 / 10.7	25 / 7.6	\$ 154.38 / coil
R-FG-MC-CLIP-0.420-M0107-050	0.42 / 10.7	50 / 15.2	\$ 292.22 / coil
R-FG-MC-CLIP-0.420-M0107-250	0.42 / 10.7	250 / 76.2	\$ 1178.17 / coil
R-FG-MC-CLIP-0.420-M0107-FT	0.42 / 10.7	By The Foot	\$ 6.90 / foot

This Product is Available By-The-Foot / Metre

Minimum Order is 6 feet. Cutting Room Fee is Waived

* See website for additional details and oven model numbers.



**Fiberglass Braided Texturized Rope with Stainless
 or Inconel Mesh Core**
1200°F / 648°C: Very High Temperature & Heat Resistant



- This rope starts with a stainless steel mesh core, providing a resilient push-back for applications such as kiln and lab oven doors.
- For clean room and paint booth applications, use part number F-FG-HT-MC instead (following page in catalogue).
- The stainless rope core is then overbraided with a high quality type E fiberglass texturized yarn that will not burn and will withstand continuous exposure to temperatures of 1200°F / 648°C.
- This material resists most acids and alkalis and is unaffected by most bleaches and solvents. It is highly flexible and conformable.

1200°F / 648°C continuous rating, high insulation value & excellent personnel protection

Very High Temperature & Heat Resistant Texturized Fiberglass Braided Rope with Stainless Mesh Core			
Part Number	OD Size inch / mm / dash#	Feet / Metres per Spool	Price per foot / Metre
R-FG-MC-M013-08	0.500 / 13 / -08	100 / 30.4	\$ 4.08 / \$ 13.38
R-FG-MC-M016-10	0.625 / 16 / -10	100 / 30.4	\$ 7.96 / \$ 26.11
R-FG-MC-M019-12	0.750 / 19 / -12	100 / 30.4	\$ 8.52 / \$ 27.95
R-FG-MC-M022-14	0.875 / 22 / -14	50 / 15.2	\$ 12.32 / \$ 40.41
R-FG-MC-M025-16	1.000 / 25 / -16	50 / 15.2	\$ 13.56 / \$ 44.48
R-FG-MC-M029-18	1.125 / 29 / -18	25 / 7.6	\$ 14.32 / \$ 46.97

Please enquire for pricing if you require an inconel mesh core

This product is available in full spools only



**Heat Treated Fiberglass Braided Rope with Stainless Mesh Core –
 Premium Grade - Clean Room & Paint Shop Suitable
 1200°F / 648°C: Very High Temperature & Heat Resistant**

Extremely clean heat treated braid for clean-room & paint shop gasket applications

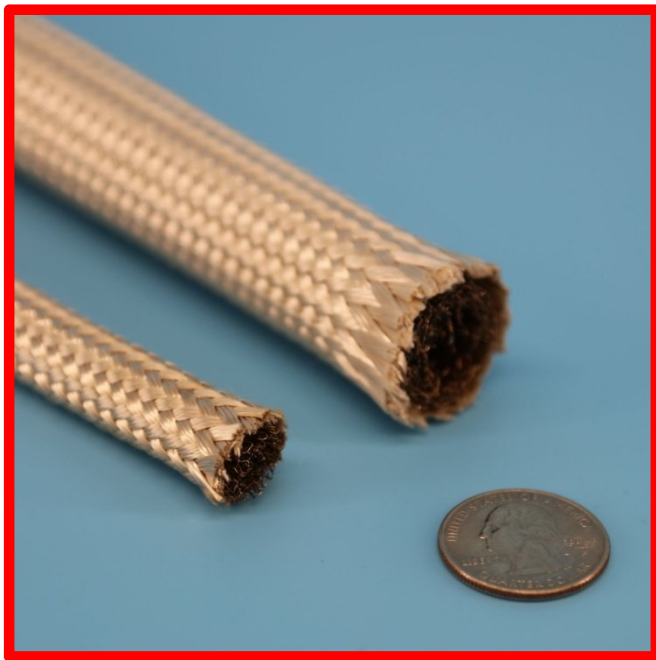

- This rope starts with a stainless steel mesh core, providing a resilient push-back for applications such as kiln and lab oven doors, paint shop drying ovens.
- The stainless rope core is then overbraided with a high quality type E fiberglass filament yarn that will not burn and will withstand continuous exposure to temperatures of 1200°F / 648°C.
- This material resists most acids and alkalis and is unaffected by most bleaches and solvents. It is highly flexible and conformable.
- The filament yarn provides an extremely smooth and clean surface to the rope shell, and is excellent for use in clean room and paint shop ovens where loose fibers are not tolerated.

1200°F / 648°C continuous rating, high insulation value & excellent personnel protection

Very High Temperature & Heat Resistant Filament Fiberglass Braided Rope with Stainless Mesh Core – Premium Grade Clean Room and Paint Booth Oven Applications			
Part Number	OD Size inch / mm / dash#	Feet / Metres per Spool	Price per foot / Metre
R-FG-HT-MC-M013-08	0.500 / 13 / -08	100 / 914	\$ 4.89 / \$ 15.98
R-FG-HT-MC-M016-10	0.625 / 16 / -10	100 / 609	\$ 9.15 / \$ 29.93
R-FG-HT-MC-M019-12	0.750 / 19 / -12	100 / 243	\$ 9.79 / \$ 32.04
R-FG-HT-MC-M022-14	0.875 / 22 / -14	100 / 182	\$ 14.17 / \$ 46.33
R-FG-HT-MC-M025-16	1.000 / 25 / -16	100 / 243	\$ 15.60 / \$ 50.99
R-FG-HT-MC-M029-18	1.125 / 29 / -18	100 / 182	\$ 16.46 / \$ 53.85

Please enquire for pricing if you require an inconel mesh core

This Product is Available By Spool Lengths Only

Stainless Steel Wire Jacketed Fiberglass Kiln Door Seal Rope 1200°F / 648°C: Very High Temperature & Heat Resistant



- Stainless Knit Overbraid provides superior abrasion resistance
- Single or Double Rope - with rope or wire mesh cores.
- Designed for high-cycle kiln doors.
- Helps prevent cold spots in the kiln.
- Improves efficiency and controls heat loss by providing a superior seal.
- Part Number R-FG-SWJ-MXXX-XX-Y.
(XXX-XX is the size, Y is the style)

Fabricated from high quality type E fiberglass that will not burn and will withstand continuous exposure to temperatures of 1200°F / 648°C.

This material resists most acids and alkalis and is unaffected by most bleaches and solvents. It is highly flexible and conformable. The base fiber is manufactured to the specifications of ASTM D-578, ASTM committee D13, and subcommittee D13.18.

The seals are then jacketed with a knitted 304 stainless steel wire mesh, providing significant abrasion resistance. These gaskets are also available with a 304 Stainless Mesh Core

Supplied cut to length, each seal can be custom fabricated from a wide variety of diameters and configurations to provide the precise thickness and depth of seal for each U channel design specification. Pre-engineering each seal insures a simple, labor saving solution to the problem of containing heat. This efficient design reduces fuel consumption and eliminates cold spots in brick/tile kilns which can cause some of the brick or tile to be under-fired.

Pricing is on application.



Stainless Steel Wire Jacketed Fiberglass Kiln Door Seal Rope 1200°F / 648°C: Very High Temperature & Heat Resistant



- 1.5" x 2.0" overall oval dimension.
- Two 7/8" 304 Stainless mesh cores. Fiberglass overbraid on each core.
- Fiberglass overbraid of both cores.
- Stainless steel jacket overbraid.
- Available in maximum 100 foot length.
- Stainless Knit Overbraid jacket provides superior abrasion resistance
- Designed for high-cycle kiln, oven and other high temperature access doors.
- Helps prevent cold spots in the kiln.
- Improves efficiency and controls heat loss by providing a superior seal.
- The overbraid is fabricated from high quality type E fiberglass that will not burn and will withstand continuous exposure to temperatures of 1200°F / 648°C.

Weight of seal is 0.866 lb/ft.

This material resists most acids and alkalis and is unaffected by most bleaches and solvents. It is highly flexible and conformable. The base fiber is manufactured to the specifications of ASTM D-578, ASTM committee D13, and subcommittee D13.18.

The seals are then jacketed with a knitted 304 stainless steel wire mesh, providing significant abrasion resistance.

Other configurations and sizes are available. This efficient design reduces fuel consumption and eliminates cold spots in brick/tile kilns which can cause some of the brick or tile to be under-fired.

Very High Temperature & Heat Resistant 1.5" x 2.0" Oven, Kiln and Furnance access door seal 304SS Mesh Core - Heat Treated DeltaGlass Over-braid - 304SS Outer Mesh Jacket		
Part Number	Length	Price
R-FG-MC-SWJ-FE15500-1.5X2.0-100	100 feet / 30 metres	\$ 2409.30
R-FG-MC-SWJ-FE15500-1.5X2.0-50	50 feet / 15 metres	\$ 1338.50
R-FG-MC-SWJ-FE15500-1.5X2.0-25	25 feet / 7.5 metres	\$ 803.10
R-FG-MC-SWJ-FE15500-1.5X2.0-1	By-the-foot / metre	\$ 38.55 / ft / \$ 126.44 / m



Stainless Steel Wire Jacketed Turbine Exhaust Gasket Seal 1200°F / 648°C: Very High Temperature & Heat Resistant



- Designed for gas turbine engine exhaust sealing.
- 304 Stainless Mesh Core.
- Heat Treated E-Glass core cover.
- 304 Stainless Mesh Overbraid Outer Cover.
- Improves efficiency and controls heat loss by providing a superior seal.
- P/N 4900159-23, P/N 4900159-38 and P/N 4900159-48 supplied cut to length.
- P/N F-E15600-00-00 available by-the-foot.

Very High Temperature & Heat Resistant Turbine Exhaust Gasket Sealing Rope - 1 1/8" / 29mm OD 304SS Mesh Core - Heat Treated DeltaGlass Over-braid - 304SS Outer Mesh Jacket		
Part Number	Length	Price
R-TS-4900159-23	23 feet / 7.01 metres	\$ 444.59
R-TS-4900159-38	38 feet / 11.58 metres	\$ 734.54
R-TS-4900159-48	48 feet / 14.63 metres	\$ 927.84
R-TS-FE15600-XX	By-the-foot / metre	\$ 21.67 / ft / \$ 71.08 / m
R-TS-FE15600-BULK	200 feet / 60.96 metres	\$ 3479.40

NOTE: Some of our resellers are incorrectly stating the 4900159 and FE15600 products are made with Inconel steel as standard - these part numbers are only available with 304SS as standard as the original OEM spec calls for 304SS. Inconel is available by special order only and the part number will be different. The Stainless version is completely suitable for gas turbine use.

The stainless core cover is fabricated from high quality heat treated type E fiberglass that will not burn and will withstand continuous exposure to temperatures of 1200°F / 648°C.

The E-glass material resists most acids and alkalis and is unaffected by most bleaches and solvents. It is highly flexible and conformable. The base fiber is manufactured to the specifications of ASTM D-578, ASTM committee D13, and subcommittee D13.18.



Knitted Fiberglass Rope with Graphite Coating / Impregnation:
Round Soft Rope
 1200°F / 648°C: Very High Temperature



- Graphite Coating / Impregnation

Graphite adds lubrication to result in a very slippery rope but does not add electrical conductivity.

Resists molten splash and splatter very well as it cannot stick to the graphite.

Service temperatures up to 1200°F / 648°C.

Used as a compression packing for pump and valve shafts.

Graphite coating / impregnation process results in an approximate 1/4 depth penetration into the fiberglass.

Very High Temperature Knitted Fiberglass Round Rope with Graphite Coating / Impregnation: <i>Soft Rope</i>			
Part Number	OD Size inch / mm	Feet per Spool	Price per Foot / Meter
R-FG GR-KS-01	0.062 / 1.6	2,500	\$ 1.44 / \$ 4.72
R-FG GR-KS-02	0.125 / 3	1,500	\$ 1.48 / \$ 4.85
R-FG GR-KS-03	0.187 / 5	2,100	\$ 1.53 / \$ 5.02
R-FG GR-KS-04	0.250 / 6	1,300	\$ 1.57 / \$ 5.15
R-FG GR-KS-06	0.375 / 10	750	\$ 2.04 / \$ 6.69
R-FG GR-KS-08	0.500 / 13	500	\$ 3.76 / \$ 12.33
R-FG GR-KS-10	0.625 / 16	300	\$ 4.40 / \$ 14.43
R-FG GR-KS-12	0.750 / 19	200	\$ 7.00 / \$ 22.96
R-FG GR-KS-14	0.875 / 22	150	\$ 7.84 / \$ 25.72
R-FG GR-KS-16	1.000 / 25	125	\$ 12.48 / \$ 40.93
<i>R-FG-GR-KS-20 *</i>	1.250 / 32	85	Spool Price \$ 1298.80
<i>R-FG-GR-KS-24 *</i>	1.500 / 38	55	Spool Price \$ 856.35

* These items are sold in full length spools only.

This Product is Available By The Foot



Knitted Fiberglass Rope with Graphite Impregnation: *Round Dense Rope* 1200°F / 648°C: Very High Temperature

- Graphite Coating / Impregnation



Graphite adds lubrication to result in a very slippery rope but not electrical conductivity.

Resists molten splash and splatter very well as it cannot stick to the graphite.

Service temperatures up to 1200°F / 648°C.

Used as a compression packing for pump and valve shafts.

Graphite coating / impregnation process results in an approximate 1/4 depth penetration into the fiberglass.

Very High Temperature Knitted Fiberglass Round Rope with Graphite Coating / Impregnation: <i>Dense Rope</i>			
Part Number	OD Size inch / mm	Feet per Spool	Price per Foot / Meter
R-FG-GR-KD-02	0.125 / 3	1,500	\$ 0.76 / \$ 2.49
R-FG-GR-KD-03	0.187 / 5	1,750	\$ 0.84 / \$ 2.76
R-FG-GR-KD-04	0.250 / 6	1,100	\$ 1.28 / \$ 4.20
R-FG-GR-KD-06	0.375 / 10	600	\$ 2.20 / \$ 7.22
R-FG-GR-KD-08	0.500 / 13	400	\$ 4.20 / \$ 13.78
R-FG-GR-KD-10	0.625 / 16	260	\$ 4.88 / \$ 16.01
R-FG-GR-KD-12	0.750 / 19	160	\$ 7.76 / \$ 25.45
R-FG-GR-KD-14	0.875 / 22	120	\$ 8.68 / \$ 28.47
R-FG-GR-KD-16	1.000 / 25	100	\$ 13.84 / \$ 45.40
R-FG-GR-KD-20 *	1.250 / 32	70	Spool Price \$ 989.10
R-FG-GR-KD-24 *	1.500 / 38	55	Spool Price \$ 951.50
R-FG-GR-KD-32 *	2.000 / 51	50	Spool Price \$ 8867.00
R-FG-GR-KD-40 *	2.500 / 64	100	Spool Price \$ 8867.00
R-FG-GR-KD-48 *	3.000 / 76	100	Spool Price \$ 9766.00
R-FG-GR-KD-64 *	4.000 / 102	100	Spool Price \$ 17688.00

* These items are sold in full length spools only.

This Product is Available By The Foot



Square Braided Fiberglass Square Braid Rope with Graphite Coating / Impregnation

1200°F / 648°C: Very High Temperature



- Graphite Coating / Impregnation
- Graphite adds lubrication to result in a very slippery rope but not electrical conductivity.
- Resists molten splash and splatter very well as it cannot stick to the graphite.
- Service temperatures up to 1200°F / 648°C.
- Used as a compression packing for pump and valve shafts.
- Graphite coating / impregnation process results in an approximate 1/4 depth penetration into the fiberglass.

Very High Temperature Square Braided Fiberglass Rope with Graphite Coating / Impregnation

Part Number	OD Size inch / mm	Feet per Spool	Feet per Pound	Price per foot
R-FG-GR-SQ-04	0.250 / 6	375	15	\$ 7.16
R-FG-GR-SQ-05	0.312 / 8	315	12.6	\$ 7.46
R-FG-GR-SQ-06	0.375 / 10	285	11.4	\$ 6.73
R-FG-GR-SQ-07	0.437 / 11	212	8.5	\$ 9.10
R-FG-GR-SQ-08	0.500 / 13	162	6.5	\$ 11.80
R-FG-GR-SQ-09	0.562 / 14	127	5.1	\$ 15.03
R-FG-GR-SQ-10	0.625 / 16	105	4.2	\$ 18.25
R-FG-GR-SQ-12	0.750 / 19	75	3	\$ 25.56
R-FG-GR-SQ-14	0.875 / 22	55	2.2	\$ 34.85
R-FG-GR-SQ-16	1.000 / 25	45	1.8	\$ 42.60
R-FG-GR-SQ-20*	1.250 / 32	26	1.05	\$ 58.41
R-FG-GR-SQ-24*	1.500 / 38	18	.75	\$ 81.78
R-FG-GR-SQ-32*	2.000 / 51	11	.45	\$ 136.30

THIS PRODUCT IS SOLD IN ONE POUND INCREMENTS



Square Braided Pure Graphite Rope
900°F / 482°C: GraphPack™ Very High Temperature & Chemical Resistant
Available Plain / with Inconel Wire Insert / with Carbon re-enforced corners



- 100% Graphite yarns
- Heat Resistant / Chemical Resistant
- Conformable and Resilient
- Thermally Conductive
- Self Lubricating
- pH range: 0 to 14
- 3000 psi standard rope; 4000 psi wire reinforced
- Up to 4000 FPM shaft speed
- Carbon fiber corner yarns available for greater wear resistance

Used as a compression packing for pump and valve shafts and as a stuffing box packing.

Made from flexible graphite yarn composed of exfoliated high purity crystalline mineral graphite (flake graphite).

Useable to 900°F / 482°C in normal air atmosphere; 1800°F / 982°C in steam or mild oxidization atmospheres/media and 5400°F / 2982°C in non-oxidizing atmospheres/media

Very High Temperature Square Braided Pure Graphite Rope Plain / Wire Re-enforced / Carbon Corners				
Part Number	OD Size inch / mm	Feet per Spool Plain / Wire / Carbon	Feet per Pound Plain / Wire / Carbon	Price per Pound Plain / Wire / Carbon
R-GR-SQ-02-X	0.125 / 3.2	254 / 228 / N/A	127 / 114 / N/A	\$25.20 / \$27.99 / N/A
R-GR-SQ-03-X	0.187 / 4.7	114 / 102 / N/A	57 / 51 / N/A	\$25.20 / \$27.99 / N/A
R-GR-SQ-04-X	0.250 / 6	160 / 145 / N/A	32 / 29 / N/A	\$25.20 / \$27.99 / N/A
R-GR-SQ-05-X	0.312 / 8	102 / 93 / 110	20 / 18 / 22	\$25.20 / \$27.99 / \$117.90
R-GR-SQ-06-X	0.375 / 10	66 / 66 / 80	13 / 13 / 16	\$25.20 / \$27.99 / \$117.90
R-GR-SQ-07-X	0.437 / 11	54 / 49 / 60	10 / 9 / 12	\$25.20 / \$27.99 / \$107.21
R-GR-SQ-08-X	0.500 / 13	41 / 37 / 47	8 / 7 / 9	\$25.20 / \$27.99 / \$107.21
R-GR-SQ-09-X	0.562 / 14	65 / 59 / N/A	6.5 / 5.9 / N/A	\$25.20 / \$27.99 / N/A
R-GR-SQ-10-X	0.625 / 16	53 / 48 / 63	5.3 / 4.8 / 6.3	\$25.20 / \$27.99 / \$107.21
R-GR-SQ-12-X	0.750 / 19	36 / 33 / 44	3.6 / 3.3 / 4.4	\$25.20 / \$27.99 / \$98.71
R-GR-SQ-14-X	0.875 / 22	26 / 24 / 33	2.6 / 2.4 / 3.3	\$25.20 / \$27.99 / \$98.71
R-GR-SQ-16-X	1.000 / 25	20 / 18 / 26	2 / 1.8 / 2.6	\$25.20 / \$27.99 / \$98.71

For the "X" Value in the part number: Substitute "P" for Plain, "W" for Wire, "C" for Carbon

Available Full Spool and 1 Pound Increments



Vermiculite Coated Fiberglass Rope: Soft
1500°F / 815°C: FlameShield™ 1500 High Temperature & Heat Resistant



Vermiculite coated fiberglass rope is manufactured from texturized fiberglass yarns then coated with Vermiculite, a 100% inorganic dispersion.

Third party certified to meet the requirements of ASTM E 162, ASTM E 662 & SMP 800-C for surface flammability, smoke and toxic gas generation.

Vermiculite coated rope will withstand temperatures up to 1500°F / 815°C constant exposure with excursions to 2000°F / 1093°F. Also offers abrasion resistant stability.

Soft rope has an approximate compression of 50% when pressed with thumb pressure.

Suitable as an architectural rope for public venues seeking a nautical appearance with a fire rated product.

High insulation value & excellent personnel protection. Can be used as an alternative to sleeve and tapes when wrapped over hot pipes for burn protection.

- An alternative to asbestos and ceramic based textiles.
- Highly flexible and minimal shrinkage.
- Meets Federal Railroad Administration requirements for surface flammability and rate of smoke generation.

Very High Temperature & Heat Resistant Vermiculite Coated Fiberglass Knitted Rope: Soft			
Part Number	OD Size inch / mm / dash#	Feet / metres per Spool	Price per Foot / Metre
R-FG-VC-KS-M002-01*	0.062 / 1.6 / -01	2,500 / 762	\$ 0.44 / \$ 1.45
R-FG-VC-KS-M003-02	0.125 / 3 / -02	1,500 / 457	\$ 0.45 / \$ 1.48
R-FG-VC-KS-M005-03	0.187 / 5 / -03	2,100 / 640	\$ 0.46 / \$ 1.51
R-FG-VC-KS-M006-04	0.250 / 6 / -04	1,300 / 396	\$ 0.47 / \$ 1.55
R-FG-VC-KS-M010-06	0.375 / 10 / -06	750 / 228	\$ 0.64 / \$ 2.10
R-FG-VC-KS-M013-08	0.500 / 13 / -08	500 / 152	\$ 1.04 / \$ 3.42
R-FG-VC-KS-M016-10	0.625 / 16 / -10	300 / 91	\$ 1.12 / \$ 3.67
R-FG-VC-KS-M019-12	0.750 / 19 / -12	200 / 60	\$ 1.99 / \$ 6.53
R-FG-VC-KS-M022-14	0.875 / 22 / -14	150 / 45	\$ 2.44 / \$ 8.00
R-FG-VC-KS-M025-16	1.000 / 25 / -16	125 / 38	\$ 3.64 / \$ 11.94
R-FG-VC-KS-M032-20*	1.250 / 32 / -20	85 / 25	\$ 4.57 / \$ 14.99
R-FG-VC-KS-M038-24*	1.500 / 38 / -24	55 / 16	\$ 5.90 / \$ 19.35

This Product is Available By-The-Foot Except Where Indicated

Fiber Type:	E Glass	Specific Gravity:	2.54-2.69
Breaking Tenacity:	1.71 gf/TEX. Std. 1.71 gf/TEX Wet	Tensile Strength:	450,000-500,000 psi.
Breaking Elongation:	4.81% Std. 4.81% Wet	Elastic Recovery:	100%
Average Stiffness:	2824.3 cn/TEX		

Effect of Heat: Will not burn; Retains 75% tensile at 343°C; Softens at 732-877°C; Melts at 1121-1182°C
 Effect of Acids and Alkalis; Resistance to acids is fair. Good resistance to most alkalis.
 Effect of Bleaches and Solvents: Unaffected

Minimum Order for .5" OD and less is 20 feet. Minimum order for .625" OD and larger is 10 feet.

* These items are sold in full length spools only.



Vermiculite Coated Fiberglass Rope: Dense
1500°F / 815°C: FlameShield™ 1500: High Temperature & Heat Resistant



Vermiculite coated fiberglass rope is manufactured from texturized fiberglass yarns then coated with Vermiculite, a 100% inorganic dispersion.

Third party certified to meet the requirements of ASTM E 162, ASTM E 662 & SMP 800-C for surface flammability, smoke and toxic gas generation.

Vermiculite coated rope will withstand temperatures up to 1500°F / 815°C constant exposure with excursions to 2000°F / 1093°F. Also offers abrasion resistant stability.

Dense rope has an approximate compression of 25% when pressed with thumb pressure.

Suitable as an architectural rope for public venues seeking a nautical appearance with a fire rated product.

High insulation value & excellent personnel protection. Can be used as an alternative to sleeve and tapes when wrapped over hot pipes for burn protection.

- An alternative to asbestos and ceramic based textiles.
- Highly flexible and minimal shrinkage.
- Meets Federal Railroad Administration requirements for surface flammability and rate of smoke generation.

Very High Temperature & Heat Resistant Vermiculite Coated Fiberglass Knitted Rope: Dense

Part Number	OD Size inch / mm / -dash#	Feet per Spool	Price per foot
R-FG-VC-KD-M003-02	0.125 / 3 / -02	1,500	\$ 0.48
R-FG-VC-KD-M005-03	0.187 / 5 / -03	1,750	\$ 0.50
R-FG-VC-KD-M006-04	0.250 / 6 / -04	1,100	\$ 0.52
R-FG-VC-KD-M010-06	0.375 / 10 / -06	600	\$ 0.88
R-FG-VC-KD-M013-08	0.500 / 13 / -08	400	\$ 1.52
R-FG-VC-KD-M016-10	0.625 / 16 / -10	260	\$ 2.44
R-FG-VC-KD-M019-12	0.750 / 19 / -12	160	\$ 3.32
R-FG-VC-KD-M022-14	0.875 / 22 / -14	120	\$ 5.04
R-FG-VC-KD-M025-16	1.000 / 25 / -16	100	\$ 5.52
R-FG-VC-KD-M032-20 *	1.250 / 32 / -20	70	\$ 6.37
R-FG-VC-KD-M038-24 *	1.500 / 38 / -24	55	\$ 11.80
R-FG-VC-KD-M051-32 *	2.000 / 51 / -32	50	\$ 23.70
R-FG-VC-KD-M064-40 *	2.500 / 64 / -40	100	\$ 39.57
R-FG-VC-KD-M076-48 *	3.000 / 76 / -48	100	\$ 58.73
R-FG-VC-KD-M102-64 *	4.000 / 102 / -64	100	\$ 88.33

This Product is Available By-The-Foot Except Where Indicated

Fiber Type:	E Glass	Specific Gravity:	2.54-2.69
Breaking Tenacity:	1.71 gf/TEX. Std. 1.71 gf/TEX Wet	Tensile Strength:	450,000-500,000 psi.
Breaking Elongation:	4.81% Std. 4.81% Wet	Elastic Recovery:	100%
Average Stiffness:	2824.3 cn/TEX		

Effect of Heat: Will not burn; Retains 75% tensile at 343°C; Softens at 732-877°C; Melts at 1121-1182°C
 Effect of Acids and Alkalis; Resistance to acids is fair. Good resistance to most alkalis.
 Effect of Bleaches and Solvents: Unaffected

Minimum Order for .5" OD and less is 20 feet. Minimum order for .625" OD and larger is 10 feet.

* These items are sold in full length spools only.



Vermiculite Coated Fiberglass Rope: *Twisted*
1500°F / 815°C: FlameShield™ 1500 Very High Temperature & Heat Resistant



Vermiculite coated fiberglass rope is manufactured from fiberglass yarns which are then then coated with Vermiculite, a 100% inorganic dispersion.

Third party certified to meet the requirements of ASTM E 162, ASTM E 662 & SMP 800-C for surface flammability, smoke and toxic gas generation.

Vermiculite coated rope will withstand temperatures up to 1500°F / 815°C constant exposure with short excursions to 2000°F / 1093°F. Also offers abrasion resistant stability.

Suitable as an architectural rope for public venues seeking a nautical appearance with a fire rated product.

High insulation value & excellent personnel protection. Can be used as an alternative to sleeve and tapes when wrapped over hot pipes for burn protection.

- An alternative to asbestos and ceramic based textiles.
- Highly flexible and minimal shrinkage.
- High abrasion resistance and tensile strength.
- Meets Federal Railroad Administration requirements for surface flammability and rate of smoke generation.

Very High Temperature & Heat Resistant Vermiculite Coated Fiberglass Twisted Rope			
Part Number	OD Size inch / mm	Feet per Spool	Price per foot
R-FG-VC-T-M003-02	0.125 / 3 / -02	2,525	\$ 0.32
R-FG-VC-T-M006-04	0.250 / 6 / -04	1,275	\$ 1.20
R-FG-VC-T-M010-06	0.375 / 10 / -06	969	\$ 1.60
R-FG-VC-T-M013-08	0.500 / 13 / -08	523	\$ 2.88
R-FG-VC-T-M016-10	0.625 / 16 / -10	305	\$ 4.60
R-FG-VC-T-M019-12	0.750 / 19 / -12	168	\$ 8.36
R-FG-VC-T-M022-14	0.875 / 22 / -14	144	\$ 9.72
R-FG-VC-T-M025-16	1.000 / 25 / -16	114	\$ 12.32
R-FG-VC-T-M032-20*	1.250 / 32 / -20	77	\$ 16.33
R-FG-VC-T-M038-24*	1.500 / 38 / -24	50	\$ 32.47
R-FG-VC-T-M051-32*	2.000 / 51 / -32	27	\$ 69.47

This Product is Available By-The-Foot Except Where Indicated

Fiber Type:	E Glass	Specific Gravity:	2.54-2.69
Breaking Tenacity:	1.71 gf/TEX. Std. 1.71 gf/TEX Wet	Tensile Strength:	450,000-500,000 psi.
Breaking Elongation:	4.81% Std. 4.81% Wet	Elastic Recovery:	100%
Average Stiffness:	2824.3 cn/TEX		

Effect of Heat: Will not burn; Retains 75% tensile at 343°C; Softens at 732-877°C; Melts at 1121-1182°C
 Effect of Acids and Alkalis; Resistance to acids is fair. Good resistance to most alkalis.
 Effect of Bleaches and Solvents: Unaffected

*These items are sold in full length spools only.



Vermiculite Coated Fiberglass Braided Square Rope / Dry Packing 1500°F / 815°C: FlameShield™ 1500 Very High Temperature & Heat Resistant



Vermiculite coated fiberglass braided square rope is manufactured from texturized fiberglass yarns then coated with Vermiculite, a 100% inorganic dispersion.

Third party certified to meet the requirements of ASTM E 162, ASTM E 662 & SMP 800-C for surface flammability, smoke and toxic gas generation.

Vermiculite coated rope will withstand temperatures up to 1500°F / 815°C constant exposure with excursions to 2000°F / 1093°F. Also offers abrasion resistant stability.

Square rope is often used as a square dry packing. Suitable as an architectural rope for public venues seeking a nautical appearance with a fire rated product.

High insulation value & excellent personnel protection. Can be used as an alternative to sleeve and tapes when wrapped over hot pipes for burn protection.

- Highly flexible and minimal shrinkage. Meets Federal Railroad Administration requirements for surface flammability and rate of smoke generation.

Very High Temperature & Heat Resistant Vermiculite Coated Fiberglass Square Braided Rope – Square Dry Packing			
Part Number	OD Size inch / mm	Feet per Spool / Pound	Price per foot / pound (sold by pound)
R-FG-VC-SQ-0.250-M006	0.250 / 6	375 / 15	\$ 3.68 / \$ 51.26
R-FG-VC-SQ-0.312-M008	0.312 / 8	315 / 12.6	\$ 4.16 / \$ 52.46
R-FG-VC-SQ-0.375-M010	0.375 / 10	285 / 11.4	\$ 3.99 / \$ 45.55
R-FG-VC-SQ-0.437-M011	0.437 / 11	212 / 8.5	\$ 4.88 / \$ 41.50
R-FG-VC-SQ-0.500-M013	0.500 / 13	162 / 6.5	\$ 6.39 / \$ 41.58
R-FG-VC-SQ-0.562-M014	0.562 / 14	127 / 5.1	\$ 8.16 / \$ 41.61
R-FG-VC-SQ-0.625-M016	0.625 / 16	105 / 4.2	\$ 9.87 / \$ 41.47
R-FG-VC-SQ-0.750-M019	0.750 / 19	75 / 3	\$ 13.81 / \$ 41.43
R-FG-VC-SQ-0.875-M022	0.875 / 22	55 / 2.2	\$ 18.84 / \$ 41.44
R-FG-VC-SQ-1.000-M025	1.000 / 25	45 / 1.8	\$ 23.00 / \$ 41.41
R-FG-VC-SQ-1.250-M032 *	1.250 / 32	26 / 1.05	\$ 33.19 / \$ 37.86
R-FG-VC-SQ-1.500-M038 *	1.500 / 38	18 / 0.75	\$ 50.60 / \$ 37.95
R-FG-VC-SQ-2.000-M051 *	2.000 / 51	11 / .45	\$ 84.72 / \$ 38.12

This Product is Available By-The-Pound Except Where Indicated. Standard spool is 25 pounds

Fiber Type:	E Glass	Specific Gravity:	2.54-2.69
Breaking Tenacity:	1.71 gf/TEX. Std. 1.71 gf/TEX Wet	Tensile Strength:	450,000-500,000 psi.
Breaking Elongation:	4.81% Std. 4.81% Wet	Elastic Recovery:	100%
Average Stiffness:	2824.3 cn/TEX		

Effect of Heat: Will not burn; Retains 75% tensile at 343°C; Softens at 732-877°C; Melts at 1121-1182°C
 Effect of Acids and Alkalis; Resistance to acids is fair. Good resistance to most alkalis.
 Effect of Bleaches and Solvents: Unaffected

*These sizes are sold in full length spools only.



Silica Knitted Cord/Rope - Small Size

High Temperature, Heat, Direct Flame, Molten Metal & Weld Splatter Resistant

- Used as a welding hose and cable suspension/tie-off cord in ship building and other hot work locations due to its non-combustive properties.

1800°F / 982°C: InSiMax™

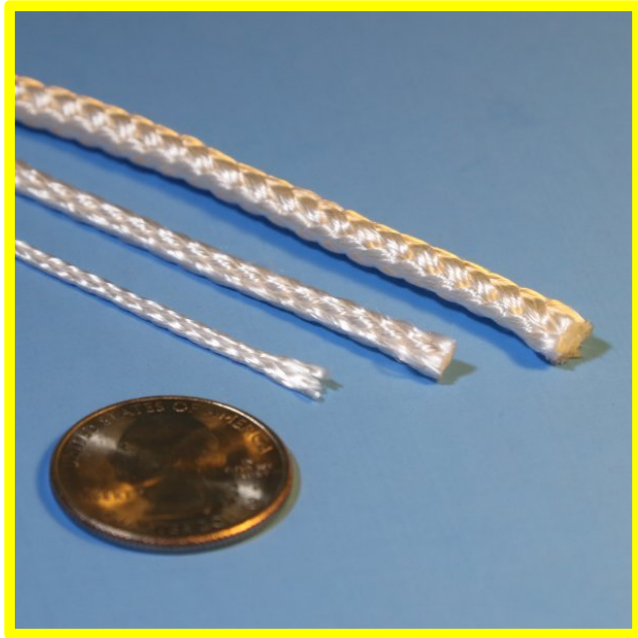

- An alternative to asbestos and ceramic based products.
- Highly flexible and minimal shrinkage.
- Good abrasion resistance and tensile strength.
- Melts above 3000°F / 1648°C.
- Produced from an extremely pure base fiber (SiO₂) and can survive harsh environments.
- Provides excellent burn-through protection from molten metal, direct flame and weld splatter.

InSiMax™ Extreme Temperature Heat & Direct Flame Resistant Knitted Silica Cord/Rope

Part Number	Size			Max Spool Length		Breaking Strength * N / kg / lbs	Price per Foot / Metre
	inch	mm	-dash	feet	metres		
R-S-KDC-M0015-01	.060	1.5	-01	650	200	70 / 7.1 / 15.7	\$ 0.21 / \$ 0.69
R-S-KDC-M003-02	.120	3	-02	650	200	90 / 9.2 / 20.2	\$ 0.34 / \$ 1.12
R-S-KDC-M006-04	.250	6	-04	650	200	110 / 11.2 / 24.7	\$ 1.40 / \$ 4.60

\$50.00 Minimum Order

This Product is Available By-The-Foot/Metre

* Breaking strength is only valid for new product at 72°F / 22°C. Strength decreases with increased temperature and with use.



Silica Knitted Rope: Dense; High Temperature, Heat, Flame, Molten Metal & Weld Splatter Resistant

1800°F / 982°C: InSiMax™ / 2000°F / 1093°C: InSiMax™ XT



- An alternative to asbestos and ceramic based products.
- Highly flexible and minimal shrinkage.
- High abrasion resistance and tensile strength.
- Melts above 3000°F / 1648°C.
- Produced from an extremely pure base fiber (SiO₂) and can survive harsh environments.
- Silica based materials provide burn-through protection from molten metal and weld splatter.

InSiMax™ & InSiMax™ XT Extreme Temperature Heat Flame Resistant Knitted Silica Rope							
Part Number	Size inch / mm / -dash			Length per Spool feet / metres		InSiMax™ Price per Foot / Metre	InSiMax™ XT Price per Foot / Metre
R-S-KD-M006-04-X	.250	6	-04	1138	346	\$ 2.16 / \$ 7.08	\$ 2.48 / \$ 8.14
R-S-KD-M010-06-X	.375	10	-06	625	190	\$ 2.40 / \$ 7.87	\$ 2.76 / \$ 9.05
R-S-KD-M013-08-X	.500	13	-08	375	114	\$ 2.88 / \$ 9.45	\$ 3.31 / \$ 10.87
R-S-KD-M016-10-X	.625	16	-10	250	76	\$ 4.04 / \$ 13.25	\$ 4.65 / \$ 15.24
R-S-KD-M019-12-X	.750	19	-12	205	62	\$ 4.88 / \$ 16.01	\$ 5.61 / \$ 18.41
R-S-KD-M022-14-X	.875	22	-14	138	42	\$ 6.24 / \$ 20.47	\$ 7.18 / \$ 23.54
R-S-KD-M025-16-X	1.000	25	-16	113	34	\$ 7.92 / \$ 25.98	\$ 9.11 / \$ 29.88
R-S-KD-M032-20-X*	1.250	32	-20	75	22	\$ 822.00 / spool	\$ 945.30 / spool
R-S-KD-M038-24-X*	1.500	38	-24	50	15	\$ 581.50 / spool	\$ 668.72 / spool

For the "X" value in the part number specify:

"IM" for 1800°F / 982°C InSiMax™

"XT" for 2000°F / 1093°C InSiMax™ XT

* These items are sold in full length spools only.
 Quantity per spool can be +/- 10%.

This Product is Available By-The-Foot Except Where Indicated



Silica Twisted Rope: High Temperature, Heat, Flame, Molten Metal & Weld Splatter Resistant
1800°F / 982°C: InSilMax™ / 2000°F / 1093°C: InSilMax™ XT
Extreme



- An alternative to asbestos and ceramic based textiles.
- Highly flexible and minimal shrinkage.
- High abrasion resistance and tensile strength.
- Melts above 3000°F / 1648°C.
- Produced from an extremely pure base fiber (SiO₂) and can be used at 2000°F / 1093°C continuously with excursions to 3000°F / 1650°C.
- Silica based materials provide burn-through protection from molten metal and weld splatter.

InSilMax™ & InSilMax™ XT Extreme Temperature Heat Flame Resistant Twisted Silica Rope						
Part Number	Size			Length per Spool feet / metres	InSilMax™ Price	InSilMax™ XT Price
	inch / mm / -dash					
R-S-T-M006-04-X*	.250	6	-04	100 / 30	\$ 387.00 / spool	\$ 445.05 / spool
R-S-T-M010-06-X*	.375	10	-06	100 / 30	\$ 591.00 / spool	\$ 679.65 / spool
R-S-T-M013-08-X*	.500	13	-08	100 / 30	\$ 762.00 / spool	\$ 876.30 / spool
R-S-T-M019-12-X*	.750	19	-12	100 / 30	\$ 1,373.00 / spool	\$ 1,578.95 / spool
R-S-T-M025-16-X*	1.000	25	-16	75 / 22	\$ 1,887.50 / spool	\$ 2,170.63 / spool

For the "X" value in the part number specify:

"IM" for 1800°F / 982°C InSilMax™

"XT" for 2000°F / 1093°C InSilMax™ XT

* These items are sold in full length spools only.
 Quantity per spool can be +/- 10%.

This Product is Available By-The-Foot Except Where Indicated



Square Braided Silica Rope: High Temperature, Heat, Flame, Molten Metal & Weld Splatter Resistant

1800°F / 982°C: InSilMax™ / 2000°F / 1093°C: InSilMax™ XT



- An alternative to asbestos and ceramic based textiles.
- Highly flexible and minimal shrinkage.
- High abrasion resistance and tensile strength.
- Melts above 3000°F / 1648°C.
- Produced from an extremely pure base fiber (SiO₂) and can be used at 2000°F / 1093°C continuously with excursions to 3000°F / 1650°C.
- Silica based materials provide burn-through protection from molten metal and weld splatter.
- Used as a square dry packing.

InSilMax™ & InSilMax™ XT Extreme High Temperature Heat Flame Resistant Square Braided Rope (Square Dry Packing Rope)						
Part Number	Size			Length per Spool feet / metres	InSilMax™ Price per foot	InSilMax™ XT Price per foot
	inch	mm	-dash			
R-S-SQ-M006-04-X*	.250	6	-04	825 / 251	\$ 3.13	\$ 3.60
R-S-SQ-M010-06-X*	.375	10	-06	415 / 126	\$ 5.43	\$ 6.25
R-S-SQ-M013-08-X*	.500	13	-08	250 / 76	\$ 6.76	\$ 7.78
R-S-SQ-M016-10-X*	.625	16	-10	135 / 41	\$ 11.13	\$ 12.80
R-S-SQ-M019-12-X*	.750	19	-12	105 / 32	\$ 15.20	\$ 17.48
R-S-SQ-M022-14-X*	.875	22	-14	75 / 22.8	\$ 19.40	\$ 22.31
R-S-SQ-M025-16-X*	1.000	25	-16	65 / 19.8	\$ 21.50	\$ 24.73
R-S-SQ-M032-20-X*	1.250	32	-20	42 / 12.8	\$ 39.83	\$ 45.81
R-S-SQ-M038-24-X*	1.500	38	-24	32 / 9.7	\$ 46.98	\$ 54.01
R-S-SQ-M051-32-X*	2.000	51	-32	19 / 5.7	\$ 113.13	\$ 130.10

-15% for Full Spool Purchase

For the "X" value in the part number specify:

"IM" for 1800°F / 982°C InSilMax™

"XT" for 2000°F / 1093°C InSilMax™ XT

*These items are sold in full length spools only. Quantity per spool can be +/- 10%.



Ceramic Fiber Braided Rope: Premium & Industrial Grade
2300°F / 1260°C: CerMax™ Extreme High Temperature, Heat & Flame Resistant



- A replacement and an alternative to asbestos. Highly flexible and minimal shrinkage.
- Melts above 3000°F / 1648°C.
- Produced from an extremely pure base fiber and can be used at 2300°F / 1260°C continuously with excursions to 3000°F / 1650°C.

CerMax™ Extreme High Temperature +Plus, Heat & Flame Resistant Ceramic Fiber Braided Rope: Premium & Industrial Grade									
Part Number	Size			Spool length		Price per spool		Price per foot	
	inch	mm	-dash	feet	metres	Premium	Industrial	Premium	Industrial
R-C-B-X-M006-04-Y	.250	6	-04	700	213	\$ 770.83 / \$ 616.66		\$ 1.72 / \$ 1.32	
R-C-B-X-M010-06-Y	.375	10	-06	370	112	\$ 957.88 / \$ 766.31		\$ 4.04 / \$ 3.11	
R-C-B-X-M013-08-Y	.500	13	-08	525	160	\$ 1129.16 / \$ 903.33		\$ 3.35 / \$ 2.58	
R-C-B-X-M016-10-Y	.625	16	-10	350	106	\$ 1146.79 / \$ 917.43		\$ 5.11 / \$ 3.93	
R-C-B-X-M019-12-Y	.750	19	-12	250	76	\$ 1151.71 / \$ 921.37		\$ 7.18 / \$ 5.52	
R-C-B-X-M022-14-Y	.875	22	-14	180	54	\$ 1178.29 / \$ 942.63		\$ 10.21 / \$ 7.85	
R-C-B-X-M025-16-Y	1.000	25	-16	125	38	\$ 1206.06 / \$ 964.85		\$ 15.04 / \$ 11.57	
R-C-B-X-M029-20-Y	1.250	32	-20	100	30	\$ 1224.01 / \$ 979.21		\$ 19.08 / \$ 14.68	
R-C-B-X-M032-24-Y	1.500	38	-24	75	22	\$ 1232.64 / \$ 986.11		\$ 25.64 / \$ 19.72	
R-C-B-X-M051-32-Y	2.000	51	-32	48	14	\$ 1243.23 / \$ 994.58		\$ 40.40 / \$ 31.08	

For the “X” value in the part number: use “P” to specify Premium grade
 use “I” to specify Industrial grade

For the “Y” value in the part number: use “SP” to specify full spool
 use “FT” to specify By-The-Foot

Minimum Order for this product is \$50.00 for By-The-Foot Lengths



Ceramic Twisted Fiber Rope: Premium & Industrial Grade
2300°F / 1260°C: CerMax™ Extreme High Temperature, Heat & Flame Resistant



- A replacement and an alternative to asbestos. Highly flexible and minimal shrinkage.
- Melts above 3000°F / 1648°C.
- Produced from an extremely pure base fiber and can be used at 2300°F / 1260°C continuously with excursions to 3000°F / 1650°C.

CerMax™ Extreme High Temperature +Plus, Heat & Flame Resistant Ceramic Fiber Twisted Rope: Premium & Industrial Grade							
Part Number	Size			Spool length		Price per spool	
	inch / mm / -dash			feet / metres		Premium / Industrial	Premium / Industrial
R-C-T-X-M006-04-Y	.250	6	-04	900	274	\$ 700.16 / \$ 560.13	\$ 1.21 / \$ 0.93
R-C-T-X-M010-06-Y	.375	10	-06	510	155	\$ 723.05 / \$ 578.44	\$ 2.21 / \$ 1.70
R-C-T-X-M013-08-Y	.500	13	-08	750	228	\$ 1196.71 / \$ 957.37	\$ 2.48 / \$ 1.91
R-C-T-X-M016-10-Y	.625	16	-10	500	152	\$ 1214.03 / \$ 971.22	\$ 3.78 / \$ 2.91
R-C-T-X-M019-12-Y	.750	19	-12	375	114	\$ 1235.59 / \$ 988.47	\$ 5.14 / \$ 3.95
R-C-T-X-M022-14-Y	.875	22	-14	275	83	\$ 1247.02 / \$ 997.61	\$ 7.07 / \$ 5.44
R-C-T-X-M025-16-Y	1.000	25	-16	225	68	\$ 1267.98 / \$ 1014.38	\$ 8.79 / \$ 6.76
R-C-T-X-M029-20-Y	1.250	32	-20	155	47	\$ 1279.66 / \$ 1023.73	\$ 12.88 / \$ 9.91
R-C-T-X-M032-24-Y	1.500	38	-24	110	33	\$ 1293.15 / \$ 1034.52	\$ 18.34 / \$ 14.11
R-C-T-X-M051-32-Y	2.000	51	-32	55	16	\$ 1306.48 / \$ 1045.18	\$ 37.08 / \$ 28.50

For the "X" value in the part number: use "P" to specify Premium grade
 use "I" to specify Industrial grade

For the "Y" value in the part number: use "SP" to specify full spool
 use "FT" to specify By-The-Foot

Minimum Order for this product is \$50.00 for By-The-Foot Lengths



Ceramic Fiber Square Braided Rope - Dry Packing Premium & Industrial Grade

2300°F / 1260°C: CerMax™ Extreme High Temperature, Heat & Flame Resistant



- A replacement and an alternative to asbestos. Highly flexible and minimal shrinkage.
- Melts above 3000°F / 1648°C.
- Produced from an extremely pure base fiber and can be used at 2300°F / 1260°C continuously with excursions to 3000°F / 1650°C.
- A rope with inconel wire insert is also available.

CerMax™ Extreme High Temperature, Heat & Flame Resistant Ceramic Fiber Square Braided Rope: Premium & Industrial Grade

Part Number	Size inch / mm / -dash			Spool length feet / metres		Price per spool Premium / Industrial		Price per foot Premium / Industrial	
	R-C-SQ-X-M006-04-Y	.250	6	-04	450	137	\$ 664.55 / \$ 531.64	\$ 2.30 / \$ 1.77	
R-C-SQ-X-M010-06-Y	.375	10	-06	240	73	\$ 697.30 / \$ 557.84	\$ 4.52 / \$ 3.48		
R-C-SQ-X-M013-08-Y	.500	13	-08	350	106	\$ 1209.22 / \$ 967.38	\$ 5.39 / \$ 4.15		
R-C-SQ-X-M016-10-Y	.625	16	-10	250	76	\$ 1200.26 / \$ 960.21	\$ 7.49 / \$ 5.76		
R-C-SQ-X-M019-12-Y	.750	19	-12	165	50	\$ 1216.93 / \$ 973.54	\$ 11.51 / \$ 8.85		
R-C-SQ-X-M022-14-Y	.875	22	-14	125	38	\$ 1226.84 / \$ 981.47	\$ 15.30 / \$ 11.77		
R-C-SQ-X-M025-16-Y	1.000	25	-16	100	30	\$ 1245.69 / \$ 996.55	\$ 19.42 / \$ 14.94		
R-C-SQ-X-M029-20-Y	1.250	32	-20	70	21	\$ 1264.53 / \$ 1011.62	\$ 28.18 / \$ 21.68		
R-C-SQ-X-M032-24-Y	1.500	38	-24	50	15	\$ 1277.41 / \$ 1021.93	\$ 39.86 / \$ 30.66		
R-C-SQ-X-M051-32-Y	2.000	51	-32	33	10	\$ 1284.09 / \$ 1027.27	\$ 60.69 / \$ 46.69		

For the "X" value in the part number: use "P" for Premium grade; use "I" to for Industrial grade

For the "Y" value in the part number: use "SP" for full spool; use "FT" to specify By-The-Foot

Minimum Order for this product is \$50.00 for By-The-Foot Lengths



Ceramic Fiber Square Braided Rope - Dry Packing - with Wire Insert
Premium & Industrial Grade
2300°F / 1260°C: CerMax™ Extreme High Temperature, Heat & Flame Resistant



- A replacement and an alternative to asbestos. Highly flexible and minimal shrinkage.
- Melts above 3000°F / 1648°C.
- Produced from an extremely pure base fiber and can be used at 2300°F / 1260°C continuously with excursions to 3000°F / 1650°C.
- Inconel wire insert for added dimensional stability and tensile strength enhancement.

CerMax™ Extreme High Temperature, Heat & Flame Resistant Ceramic Fiber Square Braided Rope: Wire Inserted - Premium & Industrial Grade						
Part Number	Size			Spool length		Price per spool Premium / Industrial
	inch	mm	-dash	feet	metres	
R-C-SQ-WI-X-M006-04	.375	10	-06	500	152	\$ 908.28 / \$ 726.63
R-C-SQ-WI-X-M013-08	.500	13	-08	300	91	\$ 908.28 / \$ 726.63
R-C-SQ-WI-X-M016-10	.625	16	-10	215	65	\$ 908.28 / \$ 726.63
R-C-SQ-WI-X-M019-12	.750	19	-12	150	45	\$ 908.28 / \$ 726.63
R-C-SQ-WI-X-M022-14	.875	22	-14	110	33	\$ 908.28 / \$ 726.63
R-C-SQ-WI-X-M025-16	1.000	25	-16	88	26	\$ 908.28 / \$ 726.63
R-C-SQ-WI-X-M029-20	1.250	32	-20	60	18	\$ 908.28 / \$ 726.63
R-C-SQ-WI-X-M032-24	1.500	38	-24	43	13	\$ 908.28 / \$ 726.63
R-C-SQ-WI-X-M051-32	2.000	51	-32	27	8	\$ 908.28 / \$ 726.63

For the "X" value in the part number: use "P" to specify Premium grade
 use "I" to specify Industrial grade

CerMax Rope Technical Data

CerMax is alumino-silicate based refractory fiber. White and odorless. Available with a fiberglass reinforcement. Some organic binder is present, and will smoke-off at elevated temperatures. Once the organics have smoked-off, the product will turn white again. If smoke free operation is required, then it should be heat treated before use.

Chemical & Physical Data: Total Al_2O_3 and SiO_2 > 97% (Al_2O_3 : 47%); Fe_2O_3 <1.1%. Weight Loss (1800°F) 8-10%; Refractory Fiber content >85%. Fiber diameter: 2 - 4 microns; Fiber length: 100 - 250 mm. Fiber shrinkage (1800°F, 3 hr) <3.5%

Thermal Conductivity: 570°F: 0.84 BTU/ft² °F/in (0.12 W/m °K). 1100°F: 0.91 BTU/ft² °F/in (0.13 W/m °K). 1800°F: 1.19 BTU/ft² °F/in (0.17 W/m °K).

Stainless Steel 304 Mesh Rope - Inconel 600 Mesh Rope
Stainless Maximum Temperature 1200°F / 648°C: Inconel 600 Maximum Temperature 2300°F / 1260°C



- **Excellent Compressability and pushback**
- **Excellent EMI / RFI Gasket**
- **Used as a bulb core material in tadpole tapes**
- **Available -by-the-foot**

304 Stainless Steel Mesh Rope					
OD Size inch / mm		Part Number	Price per Foot	Price per Carton	Feet per Carton
1/4"	6	R-SS-M006-04	\$ 3.05	\$ 2030.00	1000
5/16"	8	R-SS-M008-05	\$ 4.60	\$ 2300.00	1000
3/8"	10	R-SS-M010-06	\$ 5.14	\$ 3855.00	1500
1/2"	13	R-SS-M013-08	\$ 7.93	\$ 3930.00	1000
5/8"	16	R-SS-M016-10	\$ 11.54	\$ 4616.00	800
3/4"	19	R-SS-M019-12	\$ 14.74	\$ 4422.00	600
7/8"	22	R-SS-M022-14	\$ 24.54	\$ 4908.00	400
1"	25	R-SS-M025-16	\$ 29.46	\$ 4419.00	300
1 1/4"	32	R-SS-M032-20	\$ 44.14	\$ 5517.50	250
1 3/8"	35	R-SS-M035-22	\$ 51.40	\$ 3855.00	150
Inconel 600 Mesh Rope					
1/4"	6	R-IN-M006-04	\$ 9.60	\$ 4800.00	1000
3/8"	10	R-IN-M010-06	\$ 18.40	\$ 13800.00	1500
1/2"	13	R-IN-M013-08	\$ 20.66	\$ 10330.00	1000
5/8"	16	R-IN-M016-10	\$ 31.60	\$ 12640.00	800
3/4"	19	R-IN-M019-12	\$ 42.54	\$ 12762.00	600
7/8"	22	R-IN-M022-14	\$ 62.00	\$ 12400.00	400
1"	25	R-IN-M025-16	\$ 93.46	\$ 14019.00	300
1 1/4"	32	R-IN-M032-20	\$129.60	\$ 6480.00	100
1 3/8"	35	R-IN-M035-22	\$ 142.46	\$ 7123.00	100
1 7/8"	48	R-IN-M048-30	\$ 244.94	\$ 9185.25	75

Wire, Cable, Harness and Hose Overbraid Service Thermal Protection / Abrasion Protection / Organization

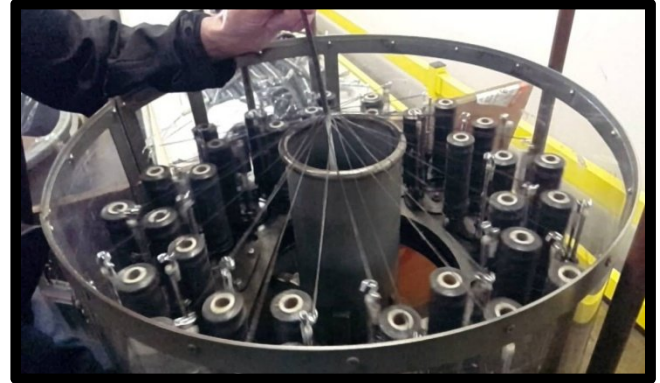

Our in-house braiding capability and experience allows us to provide exceptional quality and a timely response to protect your wiring, cables and hoses.

Available overbraid materials include e-fibreglass filament, Kevlar[®], Nomex[®], Nylon, PET, Polyester and Stainless wire

Please provide a description of your materials and sizing to allow us to provide an accurate quotation.

Kevlar[®] & Nomex[®] are trademarks of DuPont™

High Temperature, Heat, Flame, Fire, Molten Metal & Weld Splatter Protection Materials

Fax Orders: 610-340-9054 Telephone Orders: 610-906-3549 orders@abthermal.com

Fabric / Cloth / Fireblanket

FlameShield™ Silicone Rubber Sheeting	4-1
FlameShield™ SplashShield™ Silicone Rubber 1-Side Coated Fiberglass, Heavy Duty	4-2
FlameShield™ SplashShield™ Silicone Rubber 2-Side Coated Fiberglass, Light Duty	4-3
FlameShield™ SplashShield™ Silicone Rubber 2-Side Coated Fiberglass, Medium Duty	4-4
FlameShield™ SplashShield™ Silicone Rubber 2-Side Coated Fiberglass, Heavy Duty	4-5
Dual-Coat™ Heat Reflecting Silicone Rubber Sealed Fiberglass	4-6
Tuff-Flex™ Tacky Cloth Rubberized Fiberglass	4-7
Fiberglass with PTFE Coating	4-8
DeltaGlass™ Fiberglass with PTFE Resin Impregnation and Self Adhesive	4-9
DeltaGlass™ E-Glass Fiberglass: Plain, Heat Treated and Neoprene/Latex Coated	4-11
DeltaGlass™ E-Glass Fiberglass: Heat Treated and Neoprene/Latex Coated	4-12
DeltaGlass™ E-Glass Fiberglass: Weld Splatter Shield	4-13
DeltaGlass™ Fiberglass with Wire Reinforcement (HHP-31)	4-14
SteelTex™ Wire Reinforced Fiberglass Fabrics	4-15
DeltaGlass™ MIL Spec Heat Reflecting Fiberglass Fabrics with Aluminum Foil Coating	4-16
DeltaGlass™ Heat Reflecting Fabrics with Aluminum Coating	4-17
Heat Reflecting Fabric with Stainless Steel Foil Coating	4-20
Basalt Rock Fibre Fabric	4-21
DeltaMax™ S-Glass Fiberglass Fabric	4-22
Fiberglass Fabric with Vermiculite Coating	4-23
InSilMax™ Silica Fabric	4-24
InSilMax™ XT Silica Fabric	4-25
AluMax™ Alumina Fabric	4-26
Ceramic Paper & Fabric	4-27
CerMax™ Ceramic Fibre Fabric	4-28
Graphite Sheet & Roll & Laminated Sheet	4-29
Stainless Steel & Inconel Knitted Mesh Fabric	4-30

High Temperature, Heat, Flame, Fire, Molten Metal & Weld Splatter Protection Materials

Fax Orders: 610-340-9054 Telephone Orders: 610-906-3549 orders@abthermal.com



500F / 287C
Silicone Rubber Coated Fire
Blanket, Welding Blanket,
Curtain-Shield Fabric & Cloth
Page 4-1 – 4-2



550F / 287C
Rubberized Fiberglass
Tuff-Flex™ Tacky Cloth
Page 4-3



550F / 287C
Fiberglass with PTFE
Coating
Page 4-4



550F / 287C
Fiberglass with PTFE
Impregnation &
Self Adhesive
Page 4-5



1000F / 537C
Plain and Heat Treated
Fiberglass Fabric
Page 4-6



1000F / 537C
Fiberglass replacement
fabric for asbestos.
HHP31
Page 4-7



1000F / 537C
Fiberglass with wire
re-enforcement
Page 4-8

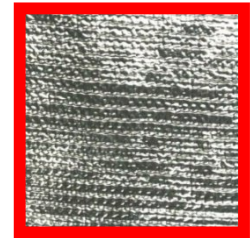

1000F/537C
Heat Reflecting
Fabrics. Aluminum &
Stainless Steel
Page 4-9 / 4-10

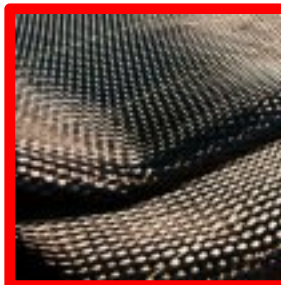

1200F / 648C
Basalt Rock Fiber
Fabric. Page 4-11



1400F / 760C
S-Glass Cloth Fabric
Page 4-12



1500F / 815C
Fiberglass with Vermiculite
Fabric. Page 4-13



1800F/982C –
2000F/1093C
InSilMax Silica Fabric.
Page 4-14 / 4-15



2300F/1260C
AluMax™ Fabric.
Page 4-16

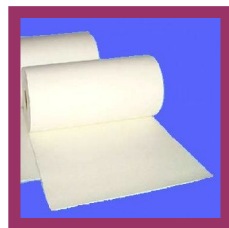

2300F / 1260C
Ceramic Paper /
Ceramic Fabric.
Page 4-17 / 4-19



950F/510C
5400F/2982C
Graphite Sheet & Roll
Page 4-20

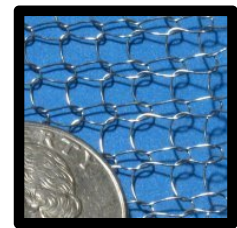

1200F/648C
Knit Mesh Fabrics.
Page 4-21



Silicone Rubber Square Sheeting – Ultra Grade
500°F / 260°C: FlameShield™ - High Temperature, Heat & Flame Resistant
Hot process protection



- Used as a heat resistant pad for hot process work.
- High thermal conductivity.
- High electrical resistance.
- Resistant to weld splatter, grinding sparks, solder drips, brazing.
- Can be used to fabricate large gaskets.
- Durometer of 50 +/- 5%. Elongation 350%. Tensile 725 psi. Color is Oxide-Red.
- Meets MIL-STD A-A-59588 Class 2A & 2B (ZZ-R-765)

FlameShield™ high temperature silicone rubber square sheet			
Part Number	Size	Thickness fraction / in / mm	Price
F-SR50-36-36-031	36" x 36"	1/32" / .031 / 0.79	\$ 113.76
F-SR50-36-36-062	36" x 36"	1/16" / .062 / 1.57	\$ 126.13
F-SR50-36-36-093	36" x 36"	3/32" / .093 / 2.36	\$ 203.15
F-SR50-36-36-125	36" x 36"	1/8" / .125 / 3.18	\$ 280.53
F-SR50-36-36-187	36" x 36"	3/16" / .187 / 4.75	\$ 335.22
F-SR50-36-36-250	36" x 36"	1/4" / .250 / 6.35	\$ 457.12
F-SR50-36-36-375	36" x 36"	3/8" / .375 / 9.52	\$ 552.68
F-SR50-36-36-500	36" x 36"	1/2" / .500 / 12.70	\$ 751.87

The color is oxide-red

This item is cut to size from our bulk rolls

These sheets can be easily used to make shields and covers that are assembled with mechanical fasteners. Easily punched or drilled for installation of grommets, or insertion of sheet metal screws or bolts.



Silicone Rubber Sheet Rolls – Premium Grade
500°F / 260°C: FlameShield™ - High Temperature, Heat & Flame Resistant
Hot process protection



- Used as a heat resistant pad for hot process work.
- High thermal conductivity.
- High electrical resistance.
- Resistant to weld splatter, grinding sparks, solder drips, brazing.
- Can be used to fabricate large gaskets.
- Durometer of 50 +/- 5%, 60 +/-5% or 70 +/- 5%. Elongation 350%. Tensile 725 psi. Color is Oxide-Red.
- Meets MIL-STD A-A-59588 Class 2A & 2B (ZZ-R-765)

FlameShield™ high temperature silicone rubber sheet				
Part Number	Durometer	Roll Size / Wt lbs	Thickness in / mm	Price / linear ft
F-SR50-36-062-X	50	36" x 50' / 61	1/16" / .062 / 1.57	\$ 22.23
F-SR50-36-093-X	50	36" x 50' / 92	3/32 / .093 / 2.36	\$ 33.20
F-SR50-36-125-X	50	36" x 50' / 122	1/8" / .125 / 3.18	\$ 44.86
F-SR50-36-250-X	50	36" x 50' / 244	1/4" / .250 / 6.35	\$ 89.70
F-SR50-48-250-X	50	48" x 50' / 326	1/4" / .250 / 6.35	\$ 120.90
F-SR60-36-062-X	60	36" x 50' / 61	1/16" / .062 / 1.57	\$ 22.23
F-SR60-36-125-X	60	36" x 50' / 122	1/8" / .125 / 3.18	\$ 44.86
F-SR60-36-250-X	60	36" x 50' / 244	1/4" / .250 / 6.35	\$ 89.70
F-SR60-48-062-X	60	48" x 50' / 82	1/16" / .062 / 1.57	\$ 29.56
F-SR60-48-125-X	60	48" x 50' / 163	1/8" / .125 / 3.18	\$ 59.66
F-SR60-48-250-X	60	48" x 50' / 326	1/4" / .250 / 6.35	\$ 120.90
F-SR70-36-062-X	70	36" x 50' / 61	1/16" / .062 / 1.57	\$ 22.23
F-SR70-36-093-X	70	36" x 50' / 92	3/32 / .093 / 2.36	\$ 33.20
F-SR70-36-125-X	70	36" x 50' / 122	1/8" / .125 / 3.18	\$ 44.86
F-SR70-36-250-X	70	36" x 50' / 244	1/4" / .250 / 6.35	\$ 89.70
F-SR70-48-062-X	70	48" x 50' / 82	1/16" / .062 / 1.57	\$ 29.56
F-SR70-48-093-X	70	48" x 50' / 122	3/32 / .093 / 2.36	\$ 44.13
F-SR70-48-125-X	70	48" x 50' / 163	1/8" / .125 / 3.18	\$ 59.66
F-SR70-48-250-X	70	48" x 50' / 326	1/4" / .250 / 6.35	\$ 120.90

- For the "X" value, Specify "F" for by-the-foot length, or "R" for full 50 foot.

Available by the linear foot. Full roll (50 feet) purchase is -10% pricing
 This item is normally stock

These materials can be easily used to make shields and covers that are assembled with mechanical fasteners. Easily punched or drilled for installation of grommets, or insertion of sheet metal screws or bolts.



Fiberglass Reinforced Silicone Rubber Sheet – AMS3320 & AMS3315
500°F / 260°C: FlameShield™ - High Temperature, Heat & Flame Resistant
Hot process protection



- Used as a gasket material due to excellent dimensional stability.
- Resistant to weathering and engine oil.
- Thicknesses of .032", .062", .093", .125", & .250". 36" and 48" roll widths.
- Resistant to weld splatter, grinding sparks, solder drips, brazing.
- Tensile 1300 psi.
- Fibreglass layer: 20x18 weave. .014" thickness. 12.5 oz/yd².
- Meets AMS3320 & AMS3315 for baffle sealing.
- Rolls lengths vary during production – please call for availability.
- Available slit into tapes for engine baffle use or precision cut to size for round, square or special shape gaskets.

FlameShield™ high temperature fibreglass reinforced silicone rubber sheet – Meets AMS3320 & AMS3315 Specifications				
Part Number	Durometer	Roll Width	Thickness in / mm	Price / linear yd
F-FGSR70-36-032-X	70	36"	1/32" / .032" / 0.79	\$ 106.10
F-FGSR70-36-062-X	70	36"	1/16" / .062" / 1.57	\$ 116.96
F-FGSR70-48-062-X	70	48"	1/16" / .062" / 1.57	\$ 155.96
F-FGSR70-36-093-X	70	36"	3/32" / .093" / 2.36	\$ 140.36
F-FGSR70-36-125-X	70	36"	1/8" / .125" / 3.18	\$ 175.46
F-FGSR70-48-125-X	70	48"	1/8" / .125" / 3.18	\$ 233.92
F-FGSR70-36-250-X	70	36"	1/4" / .250" / 6.35	\$ 327.50

- **For the "X" value, specify length in yards.**
 - **Minimum order is 2 yards**

These materials can be easily used to make shields and covers that are assembled with mechanical fasteners. Easily punched or drilled for installation of grommets, or insertion of sheet metal screws or bolts.

Can be easily slit by hand with a straight edge and knife into tapes for fitting engine baffles by hand. Rolls can also be machine slit.

The edges of this material may be sealed with liquid silicone or paste in order to seal the fiber ends to prevent wicking of liquids or contamination. See our part numbers US-ESD (liquid silicone) and US-ESP (paste silicone).



Silicone Thermal Transfer Insulator Pad Fabrics:
Fiberglass reinforced and polyimide reinforced
-150°F to 400°F / -100°C to 204°C: DeltaGlass™

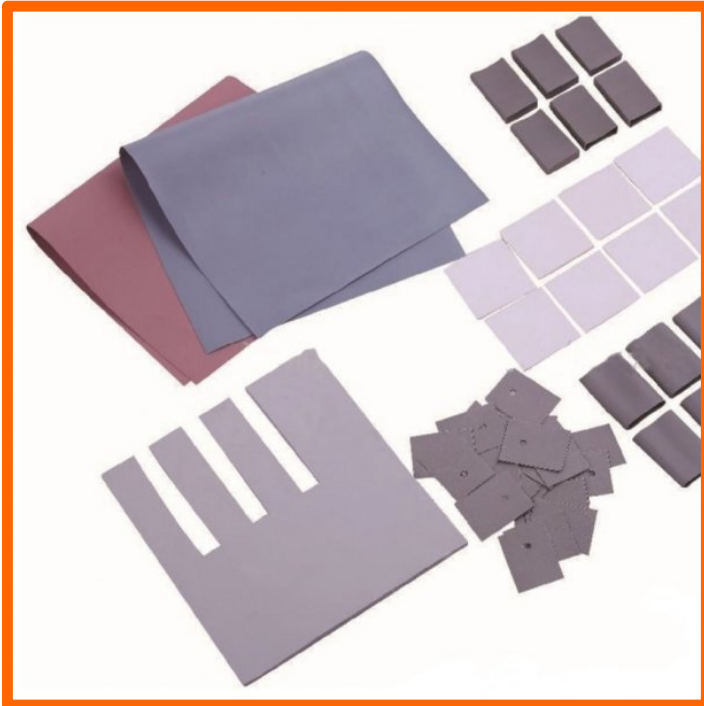

- Type 4500 fabric was designed for LED and Power semiconductor applications for maximum reliability.
- Fiberglass core or Kapton® core.
- This material resists heat, humidity and shock.
- Conforms to surface topography, maximizing contact area for uniform heat transfer.
- UL94 V-0 flame rating.
- 150°C RTI (Relative Thermal Index).
- Halogen free, RoHS compliant.
- Formulated for superior heat transfer characteristics.

Thermal Transfer Insulator Pad Fabric – Fiberglass core		
Property	Typical Value	Test Method
Color	Mauve or Gray	Visual Inspection
Thickness	7 to 20 mils / 0.18 – 0.51mm	ASTM D374
Construction	Supported	N/A
Supporting Material	Fiberglass	N/A
Hardness	77 Shore A	ASTM D2240
Tensile Strength	850 PSI / 5.9 MPa	ASTM D412
Elongation, machine direction	4%	ASTM D412
Elongation, 45 Warp and Fill	20%	ASTM D412
Thermal Conductivity	0.87 btu/(hr*ft*F) / 1.5 W/m-K	ASTM D5470
Thermal Impedance @ 40 PSI	0.3 in ² * C/W / 1.9e ⁻⁴ m ² * K/W	ASTM D5470
Glass Transition Temperature	-180F / -118C	ASTM D3418
Operating Range	-150 to 400F / -100 to 204C	N/A
Dielectric Strength, kVac	➤ 500 V/mil / > 19 kV/mm	ASTM D149
Flammability Rating	V-0	UL 94
RTI, Mechanical	300F / 150C	UL 746
RTI, Electrical	300F / 150C	UL 746
Hot Wire Ignition (HWI)	4 @ 7 mils / 3 @ 20 mils 4 @ 0.17mm / 3 @ 0.51mm	UL 746
High Current Arc Ignition (HAI)	3 @ 7 mils / 2 @ 20 mils 3 @ 0.17mm / 2 @ 0.51mm	UL746

Thermal Transfer Insulator Pad Fabric – Kapton® core		
Property	Typical Value	Test Method
Color	Mauve	Visual Inspection
Thickness	6 to 7.5 mils / 0.15 – 0.19mm	ASTM D374
Construction	Supported	N/A
Supporting Material	Kapton® MT, 1 mil	N/A
Hardness	77 Shore A	ASTM D2240
Elastic Modulus (< or = 1% strain)	38,900 PSI / 268 MPa	ABTG TMS A1
Shear Modulus (< or = 25% strain)	145 PSI / 1.0 MPa	ASTM D412
Elongation, 45 Warp and Fill	20%	ASTM D1002
Thermal Conductivity	0.87 btu/(hr*ft*F) / 1.5 W/m-K	ASTM D5470
Thermal Impedance @ 40 PSI	0.27 in ² * C/W / 1.8e ⁻⁴ m ² * K/W	ASTM D5470
Glass Transition Temperature	-180°F / -118°C	ASTM D3418
Operating Range	-150 to 400°F / -100 to 204°C	N/A
Dielectric Strength, kVac	➤ 1000 V/mil / > 39 kV/mm	ASTM D149
Flammability Rating	V-0	UL 94
RTI, Mechanical	300°F / 150°C	UL 746
RTI, Electrical	300°F / 150°C	UL 746
Hot Wire Ignition (HWI)	3	UL 746
High Current Arc Ignition (HAI)	2	UL746

Thermal Transfer Insulator Pad Fabrics			
16” roll width – 125 yards roll length			
Custom die cutting service available			
Part Number	Thickness, in.	Substrate	Price per Roll
F-FG-SR-4500-XX	.007 to .020	Fiberglass	\$ on request
F-KAP-SR-4500-XX	.006 to .0075	Kapton®	\$ on request

▪ The “XX” value is thickness measured in mils.

DuPont™ and Kapton® are trademarks or registered trademarks of the E.I. du Pont de Nemours Company



Fiberglass Fabric with Silicone Rubber Impregnation - Premium Grade
-100°F to 450°F / -73°C to 232°C: High Temperature Heat & Chemical Resistance
DeltaGlass™

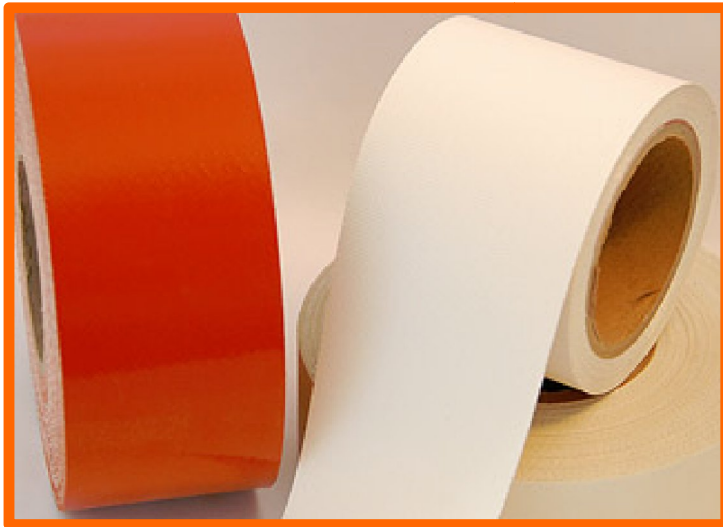

- e-fiberglass core.
- Silicone rubber coating.
- Excellent release properties.
- High dielectric factor.

This fabric offers higher temperature range with excellent resistance to almost all solvents, caustics and acids. Non-porous finish. Welding splatter, spark and molten splash resistant.

The base fabric is rated to 1200°F / 648°C.

Used as gaskets, safety curtains, conveyor belts. Rolls easily slit to specific widths to use as tapes.

450°F / 232°C continuous rating, high insulation value & excellent personnel protection

High Temperature, Heat & Chemical Resistance DeltaGlass™ E-glass Fiberglass Fabric with Silicone Rubber Coating – Premium Grade					
Part Number	Thickness, in.	Tensile warp lbs/in	Available width, in.	Weight oz/yd ²	Price per linear yard
F-FG-SR2-P-009339-10-W	.0093	74	39	10	\$ 76.70 ¹
F-FG-SR2-P-015039-16-R/W	.0150	229	39	16	\$ 69.85 ¹
F-FG-SR2-P-020339-22-R	.0203	263	38	22	\$ 72.20 ¹
F-FG-SR2-P-022039-22-R/W	.0220	285	39	22	\$ 108.15 ¹
F-FG-SR1-P-023037.5-24-R*	.0230	350	37.5	24	\$ 102.17 ¹
F-FG-SR2-P-029539-32-R	.0295	286	39	32	\$ 130.93 ²
F-FG-SR2-P-040039-41-W	.0400	410	39	41	\$ 137.73 ²

- * This fabric is coated with a saturation process that leave the reverse side fabric sealed but with no extra coverage over the base fabric.
- W at the end of the part number indicates white color. R indicates red color.
- Full roll lengths are available at 18 yards and 36 yards.
- ¹ Minimum order for cut lengths is 2 yards. ² Minimum order for cut lengths is 1 yards

This Product is Available By-The-Yard: Discounts for full roll purchases



Fiberglass Fabric with Silicone Rubber Impregnation - Premium Grade
FDA 21CFR177.1550 compliant for direct food contact
-100°F to 350°F / -73°C to 176°C: High Temperature Heat & Chemical Resistance
DeltaGlass™

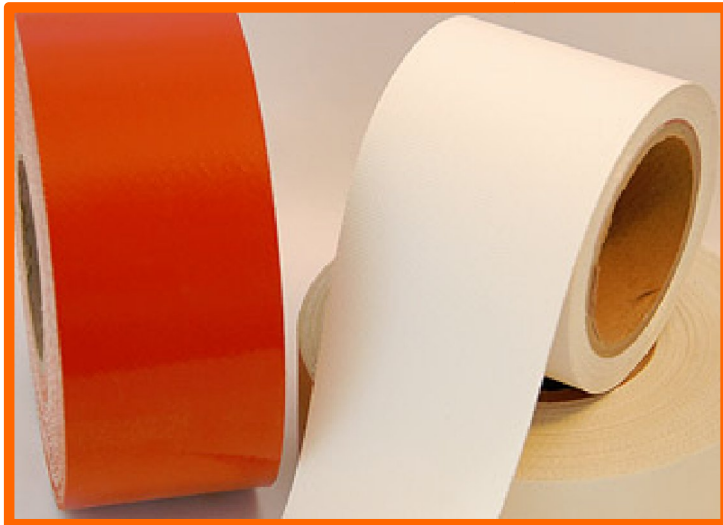

- e-fiberglass core
- silicone rubber coating both sides or PTFE one side and silicone rubber on the other side
- excellent release properties
- High dielectric factor

This fabric offers higher temperature range with excellent resistance to almost all solvents, caustics and acids. Non-porous finish.

The base fabric is rated to 1200°F / 648°C.

Used in food processing for baking and conveyor applications

450°F / 232°C continuous rating, high insulation value & excellent personnel protection

High Temperature, Heat & Chemical Resistance DeltaGlass™
E-glass Fiberglass Fabric with Silicone Rubber Coating – Premium Grade
FDA complaint 21CFR177.1550 for direct food contact

Part Number	Thickness, in.	Tensile warp lbs/in	Available width, in.	Weight oz/yd ²	Price per Roll
F-FG-SR2-FDA-009339-10-W	.0095	155	38	12.6	\$ on request

This Product is Available By-The-Yard: Discounts for full roll purchases



**One Side Silicone Rubber Coated Fiberglass Cloth:
Medium & Heavy Duty**

**500°F / 260°C: FlameShield™ High Temperature, Heat & Flame Resistant
Molten Metal SplashGuard™ / Fire Blanket / Welding Blanket / Curtains-Shields**

- Heavy Duty Coated One Side: Available 50 oz/yd² and 98 oz/yd²
- Molten Metal Splash, Welding Splatter & Grinding Spark Shields and Curtains
- Robotic welding arm and elbow covers & cable protectors



Medium-Heavy Duty 50 oz/yd².....
Coated 1 side



Heavy Duty 98 oz/yd²
Coated 1 side

500°F / 260°C continuous rating with weld splatter / molten metal splash protection.
2200°F / 1205°C for periods up to 15 minutes and short excursions to 3000°F / 1650°C.

FlameShield™ 1 side coated high temperature fiberglass fabric					
Part Number	Weight Linear foot / oz/yd²	Roll Width In / cm	Thickness In / mm	Price per Yard	Price per Metre
F-FG-SR1-12540-98	2.20 lbs / 98	40 / 101	0.125 / 3.175	\$ 217.64	\$ 238.01
F-FG-SR1-06336-50*	1.10 lbs / 50	36 / 91	0.063 / 1.60	\$ 124.76	\$ 135.99

The color of this fabric is oxide-red

-98 is available in 25 yard rolls; -50 is available in 50 yard rolls

* This material may be certified to MIL-I-24244 and meets NRC 1.36.

Heavy Duty 98 oz/yd² SplashGuard™ is an extreme duty fabric often fabricated into sleeves or other forms to protect hoses, cables and equipment from extreme industrial environments. Can be used to drape over moulds and forms during liquid metal pouring operations to slow the cooling rate of the ingot. Excellent molten metal splash protection.

Heavy Duty 50 oz/yd² and other lighter fabrics and 2 side coated fabrics are used as high temperature curtains and shields, weld splatter and pyro resistant sleeves and jackets, weather or spray-down / wash-down resistant high temperature fabric for making protective covers, sleeves, jackets. Very good molten metal splash protection.

All of these fabrics provide excellent cold temperature performance with flexibility to -76°C for refrigeration and cryogenic applications. These materials can be easily used to make shield and covers that are assembled with mechanical fasteners. Easily punched or drilled for installation of grommets, or insertion of sheet metal screws or bolts.

For applications requiring better anti-fray characteristics than the F-FG-SR1-12540-98 product, consider using F-FG-SR2-12540-92; which is a two sided version of the same base fabric; providing full molten splash protection at a slightly reduced weight but with superior anti-fray due to the two sided coating.

See website for more detailed photos of these fabrics.

**This Product is Available By-The-Yard / Metre: Discounts for full roll purchases
Custom Slitting to Any Width Available**

Two Side Coated Silicone Rubber Fiberglass Cloth: Light Duty
500°F / 260°C: FlameShield™ High Temperature, Heat & Flame Resistant
Molten Metal SplashGuard™ / Fire Blanket / Welding Blanket / Curtains-Shields

- *Light Duty Coated on Two Sides*
- *Water & Oil Resistant; Flame Retardant; Low Smoke; Easily Sewn*

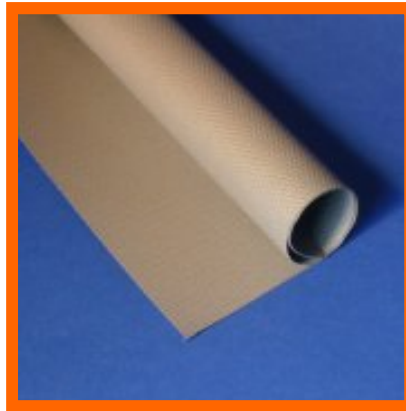

Light Duty 8.5 to 18 oz/yd²

500°F / 260°C continuous rating with weld splatter / molten metal splash protection.
 (700°F / 260°C for 100 hours results in strength loss of 50%)
 2200°F / 1205°C for periods up to 15 minutes and short excursions to 3000°F / 1650°C.

FlameShield™ 2 side silicone rubber coated high temperature fiberglass fabrics					
Light Duty					
Part Number	Weight oz/yd²	Roll Width In / cm	Thickness In / mm	Price per Yard	Price per Metre
TextureCoat™ Fabrics: Consistent coating thickness with light texture finish					
F-FG-SR2L-0960-8.5-SG	8.5	60 / 152	0.009 / 0.23	\$ 28.33	\$ 30.88
F-FG-SR2L-1460-15-SG	15	60 / 152	0.014 / 0.36	\$ 34.16	\$ 37.24
F-FG-SR2L-1560-18-SG	18	60 / 152	0.015 / 0.38	\$ 26.28	\$ 28.65
F-FG-SR2L-1560-18-OR	18	60 / 152	0.015 / 0.38	\$ 26.28	\$ 28.65

COLORS: OR = Oxide-Red / SG = Silver Grey. Other colors may available or custom fabricated.
 Available in lengths up to 150 feet / 50 Yards / 45 Metres.

These fabrics are used to fabricate sleeves and other shapes to protect hoses, cables and equipment from extreme industrial environments. Can be used to drape over moulds and forms during liquid metal pouring operations to slow the cooling rate of the ingot. Other lighter fabrics are used as high temperature curtains and shields, weld splatter and pyro resistant sleeves and jackets, weather or spray-down / wash-down resistant high temperature fabric for making protective covers, sleeves, jackets, expansion joints. All of these fabrics provide excellent cold temperature performance with flexibility to -76°C for refrigeration and cryogenic applications. Flame Resistance: All fabrics provide 1 second maximum Flame Out and Afterglow; test method FED 191/5903.2.

These fabrics are available By-The-Yard / Metre: Discounts for full roll purchases
Custom Slitting To Any Width is Available

Two Side Silicone Rubber Coated Fiberglass Cloth – Medium Duty
500°F / 260°C: FlameShield™ High Temperature, Heat & Flame Resistant
Molten Metal SplashGuard™ / Fire Blanket / Welding Blanket / Curtains-Shields

- **Medium Duty Coated on Two Sides**
- **Water & Oil Resistant; Flame Retardant; Low Smoke; Easily Sewn**

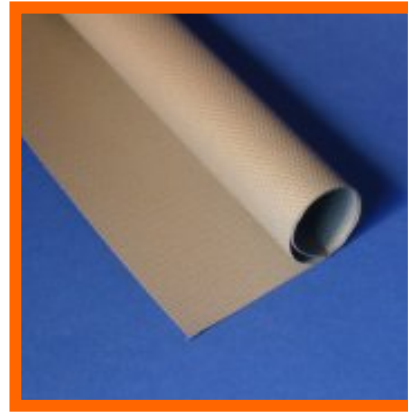

Medium Duty 18 to 26 oz/yd²

500°F / 260°C continuous rating with weld splatter / molten metal splash protection.
 (700°F / 260°C for 100 hours results in strength loss of 50%)
 2200°F / 1205°C for periods up to 15 minutes and short excursions to 3000°F / 1650°C.

FlameShield™ 2 side silicone rubber coated high temperature fiberglass fabrics					
Medium Duty					
Part Number	Weight oz/yd²	Roll Width In / cm	Thickness In / mm	Price per Yard	Price per Metre
TextureCoat™ Fabrics: Consistent coating thickness with texture finish					
F-FG-SR2M-1760-18-OR	18	60 / 152	0.018 / 0.43	\$ 38.61	\$ 42.09
F-FG-SR2M-1760-18-SG	18	60 / 152	0.018 / 0.43	\$ 38.61	\$ 42.09
F-FG-SR2M-1960-26-SG	26	60 / 152	0.019 / 0.46	\$ 61.94	\$ 67.51

COLORS: OR = Oxide-Red / SG = Silver Grey. Other colors may available or custom fabricated.
 Available in lengths up to 150 feet / 50 Yards / 45 Metres.

These fabrics are used to fabricate sleeves and other shapes to protect hoses, cables and equipment from extreme industrial environments. Can be used to drape over moulds and forms during liquid metal pouring operations to slow the cooling rate of the ingot. Other lighter fabrics are used as high temperature curtains and shields, weld splatter and pyro resistant sleeves and jackets, weather or spray-down / wash-down resistant high temperature fabric for making protective covers, sleeves, jackets, expansion joints. All of these fabrics provide excellent cold temperature performance with flexibility to -76°C for refrigeration and cryogenic applications. Flame Resistance: All fabrics provide 1 second maximum Flame Out and Afterglow; test method FED 191/5903.2.

F-FG-SR2M-1760-18-OR/SG is designed to meet the rigid requirements of aviation and nuclear applications. Meets UL214 / NFPA-701, NRC Guide 1.36 and MIL-I-24244. Tensile strength 325 lbs/inch warp minimum / 250 lbs/inch fill minimum (ASTM-D-5035); tear strength 60 lbs min warp and fill (ASTM-D-5587); burst strength 600 psi minimum (ASTM-D-3786); flame resistance char length 1/16" max, afterglow 1 second max, flame out 1 second max (ASTM D-6413 & FED 191/5903.2). Weight and thickness as per ASTM-D-3776 & ASTM-D-1777.

These fabrics are available By-The-Yard / Metre: Discounts for full roll purchases
Custom Slitting To Any Width is Available

Two Side Silicone Rubber Coated Fiberglass Cloth – Heavy Duty
Molten Metal SplashGuard™ / Fire Blanket / Welding Blanket / Curtains-Shields
500°F / 260°C: FlameShield™ High Temperature, Heat & Flame Resistant

- **Heavy Duty Coated on Two Sides**
- **Water & Oil Resistant; Flame Retardant; Low Smoke; Easily Sewn**

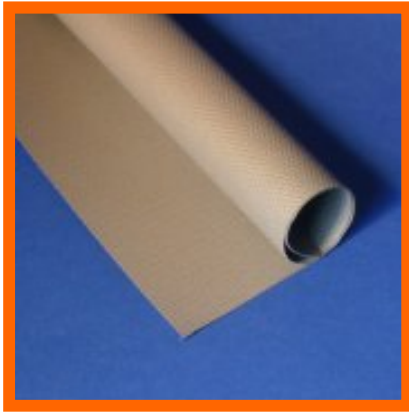

Heavy Duty 32 to 92 oz/yd²

500°F / 260°C continuous rating with weld splatter / molten metal splash protection.
 (700°F / 260°C for 100 hours results in strength loss of 50%)
 2200°F / 1205°C for periods up to 15 minutes and short excursions to 3000°F / 1650°C.

FlameShield™ 2 side silicone rubber coated high temperature fiberglass fabrics					
Heavy Duty					
Part Number	Weight oz/yd²	Roll Width In / cm	Thickness In / mm	Price per Yard	Price per Metre
TextureCoat™ Fabrics: Consistant coating thickness with texture finish					
F-FG-SR2H-3260-32-SG	32	60 / 152	0.032 / 0.81	\$ 108.16	\$ 117.89
F-FG-SR2H-3260-32-OR	32	60 / 152	0.032 / 0.81	\$ 108.16	\$ 117.89
ContourCoat™ Fabrics: Contour coating providing full protection while reducing total weight Excellent Molten Metal Splash Protection but better anti-fray compared to SR1 fabrics (previous page)					
F-FG-SR2H-6040-45-OR *	45	40 / 101	0.060 / 1.52	\$ 198.61	\$ 217.20
F-FG-SR2H-6060-45-OR *	45	60 / 152	0.060 / 1.52	\$ 217.34	\$ 237.68
F-FG-SR2H-7040-65-OR *	65	40 / 101	0.070 / 1.77	\$ 205.77	\$ 225.03
F-FG-SR2H-7060-65-OR *	65	60 / 152	0.070 / 1.77	\$ 225.55	\$ 246.66
F-FG-SR2H-12540-92-OR *	96	40 / 101	0.125 / 3.175	\$ 277.33	\$ 303.29

COLORS: OR = Oxide-Red / SG = Silver Grey. Other colors may available or custom fabricated.
 Available in lengths up to 150 feet / 50 Yards / 45 Metres. *Available in 25 yard rolls; other colors also available.

These fabrics are used to fabricate sleeves and other shapes to protect hoses, cables and equipment from extreme industrial environments. Can be used to drape over moulds and forms during liquid metal pouring operations to slow the cooling rate of the ingot. Other lighter fabrics are used as high temperature curtains and shields, weld splatter and pyro resistant sleeves and jackets, weather or spray-down / wash-down resistant high temperature fabric for making protective covers, sleeves, jackets, expansion joints. All of these fabrics provide excellent cold temperature performance with flexibility to -76°C for refrigeration and cryogenic applications. Flame Resistance: All fabrics provide 1 second maximum Flame Out and Afterglow; test method FED 191/5903.2.

These fabrics are available By-The-Yard / Metre: Discounts for full roll purchases
Custom Slitting To Any Width is Available



Heat Reflecting Silicone Rubber Sealed Fiberglass Fabric
500°F / 260°C: Dual-Coat™ Aluminum Film One Side / Silicone Rubber One Side
High Temperature & Radiant Heat Reflecting with Vapor Barrier



- Heat reflecting side is aluminum film. Perfect for applications involving movement or flexing, such as for bellows construction.
- Protection from intense radiant heat up to 3000°F.
- Reflects more than 95% of the radiant heat that contacts its surface.
- Silicone Rubber side provides excellent vapor barrier and protection from lubricating oils, wash down, contamination, etc.

Additional Technical Data

Tensile Strength: Warp: 200 lbs/inch 35.72 kg/cm
 Fill: 200 lbs/inch 35.72 kg/cm

Tear Strength: Warp: 20 lbs 9.07 kg
 Fill: 20 lbs 9.07 kg

Burst Strength: 450 psi / 31.5 kg/cm²

Flame Resistance: Char length 1" max
 Afterglow 20 seconds max
 Flame Out 10 seconds max

Dual-Coat™ Radiant Heat Reflective Protection Fabric				
Aluminum Film One Side / Silicone Rubber One Side				
Part Number	Weight oz/yd² / g/m²	Thickness in / mm	Roll width in / mm	Price per Linear Yard
F-FG-ALM-SR-1750-17	17 / 578	.017 / .432	50 / 1270	\$ 86.33

- Full rolls are 50 yards / 150 feet / 45.7 metres long
- This Product is Available By-The-Yard
- Discounts for full roll purchases
- Available as a tape - custom slitting to any width is available



White Rubber Coated Fiberglass Universal Gasket Fabric (tacky cloth) With or Without Wire Insert 550°F / 287°C: Tuff-Flex™ High Temperature Heat Resistant



This is a widely used and universal fabric for making gaskets, especially where a rough or uneven surface or flange exists. The fabric is a fiberglass base with a special white rubber formulation. The fabric is tacky, and has a plastic film surface covering that is removed before installation. The fabric will stick to itself once the film is removed.

To prevent sticking, a dusted 2-side version of the fabric is available.

For added lubrication, higher contact temperature workability a graphite coated version is available.

To facilitate installation instructions for end users, (for non symmetrical gaskets, etc.) the fabric is available with a Red/Black side (graphite on the black side).

Wire Inserted Version: The fill (widthwise) yarn for this version of the fabric has a twisted brass wired formed with it, providing additional strength and electrical conductivity/shielding.

550°F / 287°C continuous rating, excellent sealing properties as a gasket material

This fabric can be used to build shields for equipment panels, also providing high EMI/RFI shielding.

Tuff-Flex™ High Temperature White Rubber Coated Fiberglass Universal Gasket Fabric (Tacky Cloth)						
Part Number	Thickness in / mm	Feet / Metres per Roll	Price per Yard By Thickness: A / B / C / D			
			"A" Frictioned Tacky	"B" Dusted Both Sides	"C" Graphite Both Sides	"D" Red & Black
Gasket Cloth with Wire Insert						
F-FG-TC-W-06240-80-X	.0625 / 1.6	150 / 45	\$ 100.80	\$ 104.79	\$ 119.19	\$ 119.19
F-FG-TC-W-12540-160-X	.125 / 3.2	75 / 22	\$ 209.58	\$ 213.60	\$ 228.00	\$ 228.00
F-FG-TC-W-18740-240-X	.187 / 4.8	50 / 15	\$ 318.39	\$ 322.41	\$ 336.81	\$ 336.81
F-FG-TC-W-25040-320-X	.250 / 6.3	37.5 / 11	\$ 427.20	\$ 431.19	\$ 445.59	\$ 445.59
Gasket Cloth Without Wire Insert						
F-FG-TC-N-06240-80-X	.0625 / 1.6	150 / 45	\$ 82.80	\$ 92.55	\$ 101.40	\$ 101.40
F-FG-TC-N-12540-160-X	.125 / 3.2	75 / 22	\$ 172.11	\$ 173.55	\$ 190.68	\$ 190.68
F-FG-TC-N-18740-240-X	.187 / 4.8	50 / 15	\$ 258.12	\$ 260.34	\$ 276.69	\$ 276.69
F-FG-TC-N-25040-320-X	.250 / 6.3	37.5 / 11	\$ 344.19	\$ 347.16	\$ 362.73	\$ 362.73

- For the "X" value, Specify A, B, C or D in part number to correspond to the desired finish

Roll Width for all versions is 40"

Material weight is 80 oz/yd² for .0625 / 160 oz/yd² for .125 / 240 oz/yd² for .187 / 320 oz/yd² for .250

This Product is Available By-The-Yard: Discounts for full roll purchases

Curing: It is recommended that this material be cured in situ. This material must be heated to a minimum of 300°F within 60 minutes, then it must sit at 300°F or higher for 90 minutes for the rubber to fully cure.

Do not overtorque the material during this curing time or the rubber will be squeezed off of the base material.

If the material is not fully cured, the rubber will drip from the material causing voids. After curing the material can be exposed to a lower operational temperature.



Fiberglass Fabric with PTFE Coating

550°F / 287°C: High Temperature Heat & Chemical Resistance



- Fiberglass base fabric with PTFE Coating

This fabric offers the advantage of a non-asbestos material with higher temperature range and with excellent resistance to almost all solvents, caustics and acids.

The base fabric is rated to 1000°F / 537°C.

PTFE melting point is 620°F / 327°C.

This fabric is a dull white color.

550°F / 287°C continuous rating, high insulation value & excellent personnel protection

High Temperature, Heat & Chemical Resistance Fiberglass Fabric with PTFE Coating				
Part Number	Weight oz/yd ²	Roll Width In / cm	Thickness In / mm	Price per yard
F-FG-PT-6040-24N	24	40 / 101	.060 / 1.52	\$ 116.40
F-FG-PT-6060-24W	24	60 / 152	.060 / 1.52	\$ 216.00
F-FG-PT-6540-30N	30	40 / 101	.065 / 1.65	\$ 131.28
F-FG-PT-6560-30W	30	60 / 152	.065 / 1.65	\$ 266.40
F-FG-PT-7540-36N	36	40 / 101	.075 / 1.91	\$ 141.96
F-FG-PT-7540-36W	36	60 / 152	.075 / 1.91	\$ 228.24
F-FG-PT-9040-40N	40	40 / 101	.090 / 2.29	\$ 152.88
F-FG-PT-9060-40W	40	60 / 152	.090 / 2.29	\$ 271.92
F-FG-PT-12540-64N	64	40 / 101	.125 / 3.18	\$ 282.08
F-FG-PT-12560-64W	64	60 / 152	.125 / 3.18	\$ 470.40

Roll length is 50 yards / 45 Metres. Please call for pricing on fabric with PSA

This Product is Available By-The-Yard: Discounts for full roll purchases

The PTFE is applied to the rope by a proprietary sinterization process. The rope is soaked repeatedly in a PTFE dispersion, dried, and then baked. The result is a PTFE coating on the rope which is soft, robust and flexible; however, it can be abrasively removed from the rope with aggressive fingernail scraping, resulting in a thinner and thinner layer of ptfе remaining with each pass. The PTFE also causes the yarns to be sealed and the small gaps between the yarns filled, resulting in an almost air-tight / liquid-tight rope.



Fiberglass Fabric with PTFE Resin Impregnation and Self Adhesive Backing - Premium Grade

550°F / 287°C: High Temperature Heat & Chemical Resistance DeltaGlass™

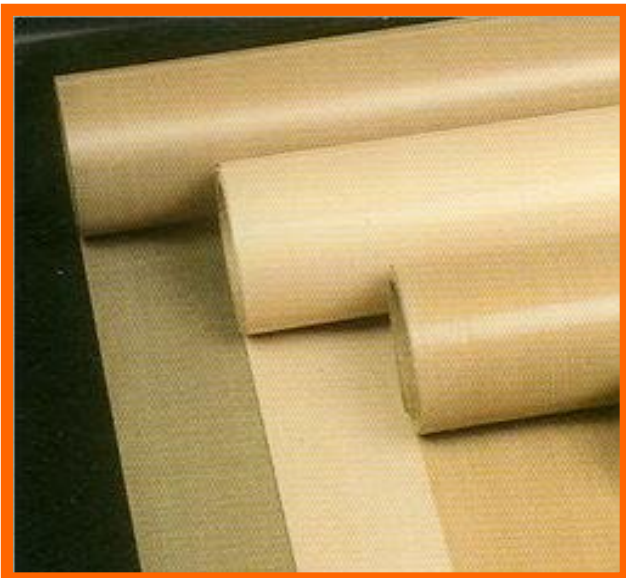

- PTFE Resin Impregnation.
- Silicone or Acrylic Adhesive with backing paper
- Roll width is 39". May be slit to narrower widths.

This fabric offers higher temperature range with excellent resistance to almost all solvents, caustics and acids. Very smooth and non-porous PTFE finish. High Temperature self adhesive backing with peel-off protection layer to reveal the adhesive. Will not cold flow under heavy loads.

The base fabric is rated to 1000°F / 537°C. PTFE melting point is 620°F / 327°C.

Used in packaging as a release surface on heat sealers, blister and form-fill sealing equipment. Also used as a lining on guide rails, chutes and slides.

550°F / 287°C continuous rating, high insulation value & excellent personnel protection

High Temperature, Heat & Chemical Resistance DeltaGlass™ Fabric with PTFE Impregnation and Self Adhesive - Premium				
Part Number	Total Thickness incl adhesive, in.	Fabric with Coating Thickness, in.	Adhesion to steel oz/in	Price per Roll
F-FG-PTRI-P-PSA-004739-X	.0047	.0030	45	\$ 2034.72
F-FG-PTRI-P-PSA-006739-X	.0067	.0050	55	\$ 2859.12
F-FG-PTRI-P-PSA-007739-X	.0077	.0060	55	\$ 3245.04
F-FG-PTRI-P-PSA-017739-X	.0177	.0100	60	\$ 3818.16
Tensile Strength Warp / Fill (lbs/in)	Silicone: .003: 95 / 55. .005: 140 / 130. .006: 150 / 115. .010: 325 / 235 Acrylic: .003: 95 / 55. .005: 125 / 130. .006: 150 / 150. .010: 325 / 235			
Tear Strength Warp / Fill (lbs)	Silicone: .003: 1.5 / 0.9. .005: 2.2 / 1.7. .006: 2.1 / 1.8. .010: 7.5 / 4.0 Acrylic: .003: 1.5 / 0.9. .005: 1.8 / 1.7. .006: 2.1 / 1.7. .010: 7.5 / 4.0			

- Adhesive Thickness is .0017 on all products. Elongation at break is less than 5%.
- Roll length is 36 yards. 18 yard rolls are available at -30% of the price shown.
- Available in Industrial and Premium grades. Premium grade has an almost perfectly smooth surface while on Industrial grade the surface profile follows the weave pattern of the underlying base fabric.
- For the "X" value specify "A" or "S" in the part number to correspond to the desired adhesive. A = Acrylic S = Silicone. -5% off price for acrylic adhesive coating.

This Product is Available By-The-Yard: Discounts for full roll purchases

The PTFE resin is applied to the fabric in a hot process and under pressure, causing a total impregnation of the base fabric. The surface of the resin is smooth and it takes considerable and aggressive force to scratch the PTFE surface to remove it from the fabric with fingernail scraping.



Fiberglass Fabric with PTFE Resin Impregnation and Self Adhesive Backing - Industrial Grade

550°F / 287°C: High Temperature Heat & Chemical Resistance DeltaGlass™

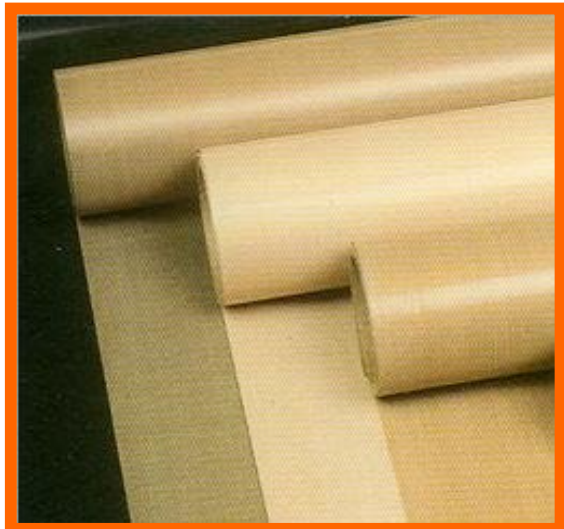

- PTFE Resin Impregnation.
- Silicone or Acrylic Adhesive with backing paper
- Roll width is 39". May be slit to narrower widths.

This fabric offers higher temperature range with excellent resistance to almost all solvents, caustics and acids. Very smooth and non-porous PTFE finish. High Temperature self adhesive backing with peel-off protection layer to reveal the adhesive. Will not cold flow under heavy loads.

The base fabric is rated to 1000°F / 537°C. PTFE melting point is 620°F / 327°C.

Used in packaging as a release surface on heat sealers, blister and form-fill sealing equipment. Also used as a lining on guide rails, chutes and slides.

550°F / 287°C continuous rating, high insulation value & excellent personnel protection

High Temperature, Heat & Chemical Resistance DeltaGlass™ Fabric with PTFE Impregnation and Self Adhesive - Industrial				
Part Number	Total Thickness incl adhesive, in.	Fabric with Coating Thickness, in.	Adhesion to steel oz/in	Price per Roll
F-FG-PTRI-I-PSA-004739-X	.0047	.0030	45	\$ 1695.60
F-FG-PTRI-I-PSA-006739-X	.0067	.0050	55	\$ 2382.48
F-FG-PTRI-I-PSA-007739-X	.0077	.0060	55	\$ 2704.32
F-FG-PTRI-I-PSA-017739-X	.0177	.0100	60	\$ 3181.68
F-FG-PTRI-I-PSA-015739-X	.0157	.0140	65	\$ 4881.60
Tensile Strength Warp / Fill (lbs/in)	Silicone: .003: 100 / 50 .005: 135 / 120 .006: 150 / 140 .010: 325 / 235 .014: 440 / 250 Acrylic: .003: 90 / 50 .005: 135 / 120 .006: 150 / 140 .010: 250 / 155 .014: 440 / 250			
Tear Strength Warp / Fill (lbs)	Silicone: .003: 1.7 / 0.9 .005: 2.3 / 1.5 .006: 2.0 / 1.5 .010: 4.9 / 3.0 .014: 7.0 / 5.0 Acrylic: .003: 1.7 / 0.9 .005: 1.8 / 1.5 .006: 2.0 / 1.5 .010: 6.0 / 3.0 .014: 7.0 / 5.0			

- Adhesive Thickness is .0017 on all products. Elongation at break is less than 5%.
- Roll length is 36 yards. 18 yard rolls are available at -30% of the price shown.
- Available in Industrial and Premium grades. Premium grade has an almost perfectly smooth surface while on Industrial grade the surface profile follows the weave pattern of the underlying base fabric.
- For the "X" value specify "A" or "S" in the part number to correspond to the desired adhesive. A = Acrylic S = Silicone. -5% off price for acrylic adhesive coating.

This Product is Available By-The-Yard: Discounts for full roll purchases

The PTFE resin is applied to the fabric in a hot process and under pressure, causing a total impregnation of the base fabric. The surface of the resin is smooth and it takes considerable and aggressive force to scratch the ptfе surface to remove it from the fabric with fingernail scraping.

Fiberglass Fabric with PTFE Resin Impregnation
FDA Compliant - 21CFR177.1550 for direct food contact
500°F / 260°C: High Temperature Heat & Chemical Resistance DeltaGlass™

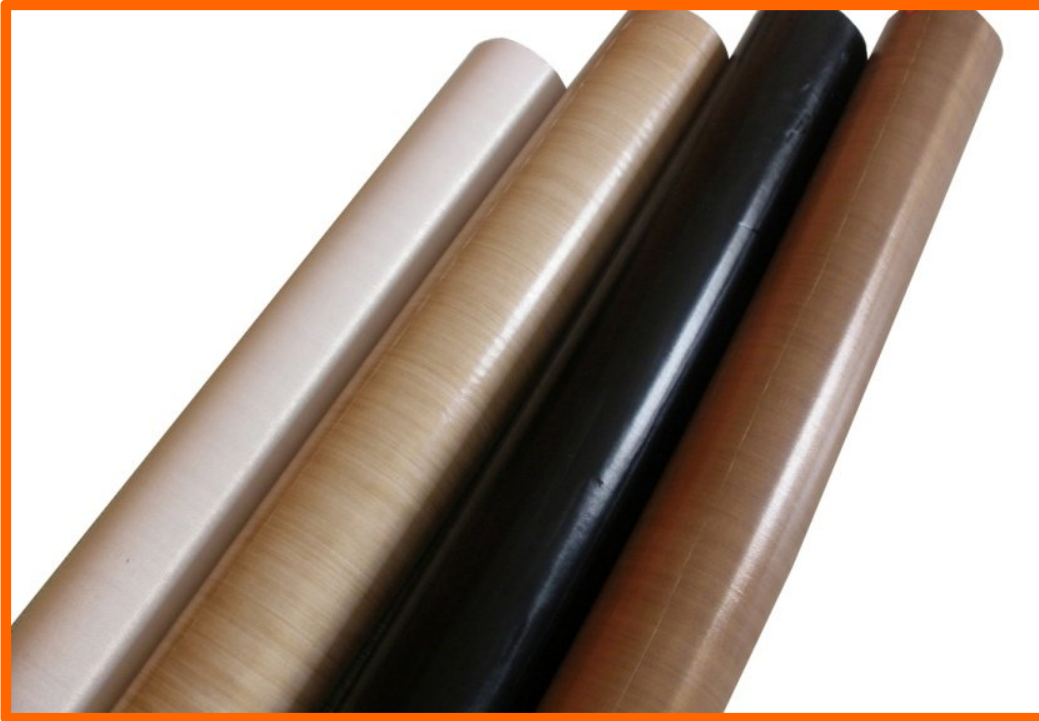

- Meets FDA 21CFR177.1550 for direct food contact - popular for pan liners and conveyors for baking applications
- PTFE Resin Impregnation.
- May be slit to narrower widths.

This fabric offers higher temperature range with excellent resistance to almost all solvents, caustics and acids. Very smooth and non-porous PTFE finish.

The base fabric is rated to 1000°F / 537°C. PTFE melting point is 620°F / 327°C.

Used in packaging as a release surface on heat sealers, blister and form-fill sealing equipment. Also used as a lining on guide rails, chutes and slides.

Fiberglass Fabric with PTFE Resin Impregnation (Continued)
FDA Compliant - 21CFR177.1550 for direct food contact
500°F / 260°C: High Temperature Heat & Chemical Resistance DeltaGlass™

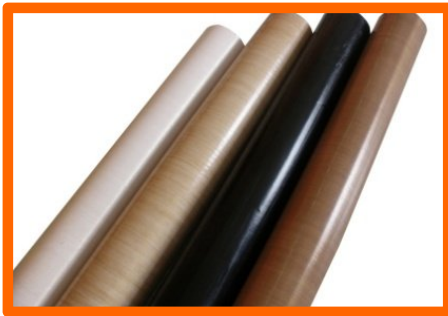

500°F / 260°C continuous rating

High Temperature, Heat & Chemical Resistance DeltaGlass™ Fabric with PTFE Impregnation – FDA Compliant						
Part Number	Overall Thickness, in.	Tensile warp/fill lbs/yd²	Available width, in.	Weight oz/yd²	Dielectric volts/mil	Price per Roll
Premium Grade – Superior fabric for pan liners and belts for food processing						
Highest PTFE-to-substrate ratio / Superior release and extended life						
F-FG-PT-FDA-P-0029XX-4.2	.0029	105 / 75	38, 50, 60	4.2	1350	\$
F-FG-PT-FDA-P-0049XX-8	.0049	170 / 160	40, 50, 60	8	1100	\$
F-FG-PT-FDA-P-0060XX-9.4	.0060	175 / 160	40, 50, 60	9.4	1200	\$
F-FG-PT-FDA-P-0095XX-16	.0095	325 / 180	37.5, 50, 60	16	850	\$
F-FG-PT-FDA-P-0105XX-17	.0105	300 / 175	44	17	700	\$
F-FG-PT-FDA-P-0140XX-23	.0140	450 / 275	37.5	23	550	\$
F-FG-PT-FDA-P-0250XX-32	.0250	410 / 600	110	32	225	\$
Standard Grade – Release sheet applications for heat sealing & laminating						
Smooth surface with superior non-stick properties / economical						
F-FG-PT-FDA-S-0026XX-3.8	.0026	100 / 75	38, 50, 60	3.8	1350	\$
F-FG-PT-FDA-S-003638-5.6	.0036	150 / 75	38	5.6	1450	\$
F-FG-PT-FDA-S-0045XX-7	.0045	160 / 150	40, 50, 60	7	1000	\$
F-FG-PT-FDA-S-0055XX-9	.0055	170 / 165	40, 50, 60	9	1200	\$
F-FG-PT-FDA-S-0090XX-15	.0090	310 / 175	37.5, 50, 60	14.	810	\$
F-FG-PT-FDA-S-013537-22	.0135	500 / 300	37	22	550	\$
F-FG-PT-FDA-S-0245XX-28	.0245	425 / 500	110, 189	28	210	\$

- Roll length is 36 yards. 18 yard rolls are available at -30% of the price shown.
- For "XX", specify applicable roll width from table

This Product is Available By-The-Yard: Discounts for full roll purchases

The PTFE resin is applied to the fabric in a hot process and under pressure, causing a total impregnation of the base fabric. The surface of the resin is smooth and it takes considerable and aggressive force to scratch the PTFE surface to remove it from the fabric with fingernail scraping. The surface is smooth and does not take on any patterning from the substrate fabric.

Very High Temperature & Heat Resistant Fiberglass Cloth Fabric:
Premium Grade
1200°F / 648°C: DeltaGlass™



- Manufactured of fiberglass yarns, has a 1200°F / 648°C continuous rating while providing high insulation value & excellent personnel protection.
- Good abrasion resistance and tensile strength. Filament and Texturized versions available.
- A high-performance very high temperature fabric, used in almost all industries for heat protection.
- Also available with coatings such as Vermiculite, PTFE, Aluminum foil/film, Neoprene/Latex. Also available with wire insert.

1200°F / 648°C continuous rating, high insulation value & excellent personnel protection

DeltaGlass™ Very High Temperature & Heat Resistant Plain Cloth Roll Fabric – Premium Grade				
Part Number	Weight oz/yd²	Roll Width In / cm	Thickness In / mm	Price per Yard / Metre
F-FG-P-0760-6	6	60 / 152	.007 / .18	\$ 13.77 / \$ 15.06
F-FG-P-0960-9	9	60 / 152	.009 / .23	\$ 22.47 / \$ 24.49
F-FG-P-6040-24	24	40 / 101	.060 / 1.52	\$ 26.85 / \$ 29.27
F-FG-P-6060-24	24	60 / 152	.060 / 1.52	\$ 37.23 / \$ 40.58
F-FG-P-6540-30	30	40 / 101	.065 / 1.65	\$ 30.18 / \$ 32.90
F-FG-P-6560-30 **	30	60 / 152	.065 / 1.65	\$ 42.36 / \$ 46.17
F-FG-P-7540-36	36	40 / 101	.075 / 1.91	\$ 32.64 / \$ 35.58
F-FG-P-7560-36	36	60 / 152	.075 / 1.91	\$ 60.60 / \$ 66.05
F-FG-P-9040-40	40	40 / 101	.090 / 2.29	\$ 35.16 / \$ 38.32
F-FG-P-9060-40	40	60 / 152	.090 / 2.29	\$ 62.52 / \$ 68.15
F-FG-P-12540-64	64	40 / 101	.125 / 3.18	\$ 71.32 / \$ 77.74
F-FG-P-12560-64 #	64	60 / 152	.125 / 3.18	\$ 117.60 / \$ 128.18
F-FG-P-25060-100	100	60 / 152	.250 / 6.36	call

Roll length is 150 Feet / 50 yards / 45 Metres. Please call for pricing on fabric with PSA

**** Note: This fabric has MSHA-BC-109 Approval and is Marked as such.**

* Note: On fabrics with PSA, the PSA will burn off at temperatures above 400°F and should be used only to facilitate installation. Material with PSA should not be used in confined areas at elevated temperatures without ventilation until all of the PSA has vaporized.

These Products are Available By-The-Yard / Metre: Discounts for full roll purchases



Heat Treated Fiberglass Cloth Fabric: Premium Grade
1200°F / 648°C: DeltaGlass™ Very High Temperature & Heat Resistant



- Manufactured of fiberglass yarns, has a 1200°F / 648°C continuous rating while providing high insulation value & excellent personnel protection.
- Good abrasion resistance and tensile strength.
- Heat Treated fabrics have impurities removed, resulting in a very clean fabric which meets marine requirements.
- Meets MIL-C-20079 Type I, Class 9
- PN F-FG-P-HT-1860-8.5 Meets MIL-C-20079 Type I, Class 3
- Designed for shipboard/marine lagging and as a jacketing material for use over insulation.
- Designed to replace asbestos materials grades UG, AA, AAA and AAA-M on turbine blankets, fittings. Flange covers, engine exhaust pipes and pipe and duct lagging.
- Available red dyed to comply with Federal Standard 595A color chip 31158.

1200°F / 648°C continuous rating, high insulation value & excellent personnel protection

DeltaGlass™ Very High Temperature & Heat Resistant Heat Treated Cloth Roll Fabric Meets USCG 164.009, MIL-C-20079F Type 1, Class 3 & MIL-I-24244B				
Part Number	Weight oz/yd ²	Roll Width In / cm	Thickness In / mm	Price per Yard / Metre
F-FG-P-HT-1860-8.5	8.5	60 / 152	.018 / .457	\$ 17.43 / \$ 19.07
F-FG-P-HT-3240-18	18	40 / 101	.032 / .81	\$ 20.16 / \$ 21.97
F-FG-P-HT-3260-18	18	60 / 152	.032 / .81	\$ 26.24 / \$ 28.60

Roll length is 150 Feet / 50 yards / 45 Metres. Please call for pricing on fabric with PSA

These Products are Available By-The-Yard / Metre: Discounts for full roll purchases



Weld Splatter Shield Fiberglass Cloth Fabric: Premium Grade
1100°F / 593°C: DeltaGlass™ Very High Temperature & Heat Resistant



- Manufactured of fiberglass yarns, has a 1100°F / 593°C continuous rating while providing high insulation value & excellent personnel protection.
- Good abrasion resistance and tensile strength.
- A neoprene/latex coating provides good weld splatter resistance.
- Can be easily cut to shape and has very good fray resistance.
- Due to the coating, this fabric has a stiffness similar to thick bristol board or a thinner cardboard, allowing it to be placed into temporary positions with its inherent stiffness holding it in place – good for applications such as assembly line brazing, or as an easy installed and removed protection shield for plumbing/welding.

1100°F / 593°C continuous rating, high insulation value & excellent personnel protection

DeltaGlass™ Very High Temperature & Heat Resistant Weld Splatter Shield Cloth Roll Fabric				
Part Number	Weight oz/yd²	Roll Width In / cm	Thickness In / mm	Price per Yard / Metre
F-FG-WS-3040-24	24	40 / 101	.030 / .79	\$ 22.53 / \$ 24.56
F-FG-WS-3060-24	24	60 / 152	.030 / .79	\$ 31.83 / \$ 34.69

Roll length is 150 Feet / 50 yards / 45 Metres. Please call for pricing on fabric with PSA

These Products are Available By-The-Yard / Metre: Discounts for full roll purchases

HHP31 Asbestos Replacement Fabric:
1200°F / 648°C: DeltaGlass™ Very High Temperature & Heat Resistant Fiberglass
Fabric with Stainless Steel Wire Insert



Fig 1 – Fabric Roll

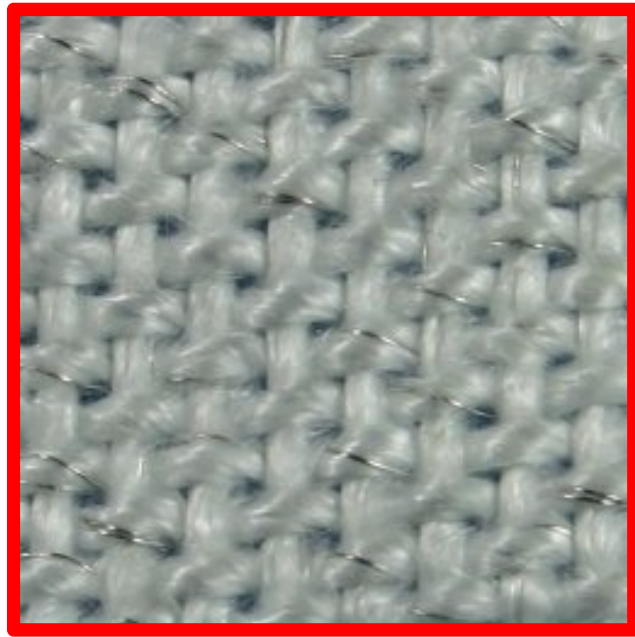

Figure 2 – Close up view

- Meets HHP31 F TY1
- Certification upon request

This fabric strengthened with an interwoven stainless steel wire which accounts for 10% of the fabric's weight. Each yarn is composed of 3 fiberglass filaments, interwoven with 2 wires, each 304 Stainless Steel (.0045" diameter), all twisted together. This provides a very dense and strong very high temperature wire mesh / fiberglass fabric with excellent tensile strength of 225 lbs Warp and 125 lbs Fill.

1100°F / 648°C continuous rating, high insulation value & excellent personnel protection

Used extensively as a gasket material for its reinforcement and high strength. This fabric can also used to build complex covers and shields for equipment panels, providing high EMI/RFI shielding. Also used for large stage proscenium fire-curtains due to the high strength of this fabric. This fabric replaces asbestos versions of HHP-31-TY 1, such as NSN 5330-00-027-2535

DeltaGlass™ Very High Temperature & Heat Resistant HHP-31 Asbestos Replacement Fabric				
Part Number	Weight oz/yd²	Roll Width In / cm	Thickness In / mm	Price per Yard / Metre
F-FG-HHP31-4160-24	24	60 / 152	.041 / 1.04	\$ 146.28 / \$ 159.45

Roll length is 150 Feet / 50 Yards / 45 Metres. Please call for pricing on fabric with PSA

Fiberglass Fabrics with Wire Inserts 1100°F / 593°C to 1300°F / 704°C: SteelTex™ Very High Temperature & Heat Resistant



- Reinforced fabrics offer dimensional stability and additional support for fabrications such as expansion joints.
- Available with 304SS Stainless Steel wire or Inconel.
- Additional surface treatments have been added to extend the temperature range of the base fabric

SteelTex™ Very High Temperature & Heat Resistant Fabric with Reinforcement Wire				
Part Number	Weight oz/yd ²	Roll Width In / cm	Thickness In / mm	Price per Yard / Metre
F-FG-WI-2550-18	18	50 / 127	.025 / .635	call
F-FG-WI-4160-24	24	60 / 152	.041 / 1.04	\$ 128.28 / \$ 139.82
F-FG-WI-8060-40	40	60 / 152	.080 / 2.03	\$ 86.70 / \$ 94.50
F-FG-WI-7060-35	35	60 / 152	.070 / 1.78	\$ 119.47 / \$ 130.22

SteelTex™ 2550-18 is a light weight fiberglass with 304 stainless steel wire re-enforcement. 1000°F / 537°C service temperature.

SteelTex™ 4160-24 is a medium weight fiberglass with 304 stainless steel wire re-enforcement similar to HHP31 but without the certification. 1000°F / 537°C service temperature.

SteelTex™ 8060-40 is a medium weight fiberglass and has a 304 stainless steel wire reinforcement in one direction. It also has a heat reflective aluminum flake coating on one side. Excellent for expansion joints, heat shields, gaskets. 1100°F / 593°C service temperature.

SteelTex™ 7060-35 is a medium weight fiberglass and has an inconel wire reinforcement in one direction. Perfect for expansion joints. Has a proprietary treatment which increases the service temperature to 1300°F / 704°C: stays soft and flexible even at high temperature.

Roll length is 150 Feet / 50 Yards / 45 Metres. Some products may be available by-the-yard.

Please call for pricing on fabric with PSA

Aluminum Film Coated Aramid Fabric / Cloth 750°F / 399°C: AraMax™ Poly-Layered High Temperature & Radiant Heat Reflecting

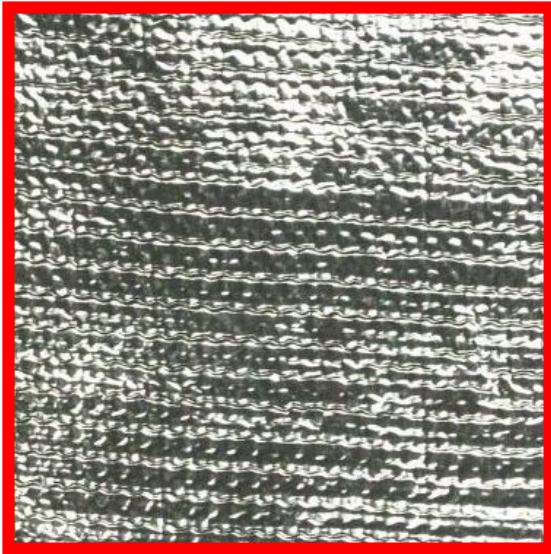

- Radiant heat reflecting fabrics based on a poly-layered aluminum film structure laminated to aramid base substrates. Excellent long-term flexibility.
- Protection from intense radiant heat up to 3000°F.
- Reflects more than 95% of the radiant heat that contacts its surface.
- Spun and Core Spun Aramid base materials.
- Excellent radiant heat protection from sources such as super-hot metal slabs, proximity to liquid metal, infrared heaters, open flame / plasma or engine exhaust manifolds is a concern.
- Suitable for work wear fabrication.

Poly-layered AraMax™ fabric offers protection when radiant heat from infrared sources such as super-hot metal slabs, proximity to liquid metal, open flame/plasma or engine exhaust manifolds is a concern. Constructed from a high-temperature aramid fiber base fabric which is then coated with heat reflective poly-layered aluminum film. The base fabric is rated to 750°F / 399°C while the radiant capability if the fabric is 3000°F.

AraMax™ Poly-Layered Aluminized Film on Aramid Fabric Radiant Heat Reflective Protection				
Part Number	Weight oz/yd² / g/sq m	Thickness in / mm	Roll width in / mm	Price Linear Yard
F-AK-ALM-2360-10 (twill 50x44 spun)	10 / 340	.023 / 0.60	60 / 1524	\$ 144.70
F-AK-ALM-5740-19 (plain x core spun)	19 / 645	.057 / 1.45	40 / 1016	\$ 77.22
F-AK-ALM-6340-24 (plain 21x12 core spun)	24 / 746	.063 / 1.63	40 / 1016	\$ 89.66

- **Full rolls are 50 yards / 150 feet / 45.7 metres long**
- **This Product is also available By-The-Yard**
- **Discounts apply at 10 yards and full roll purchases**



Aluminum Foil Coated High Temperature & Radiant Heat Reflective Fabric / Cloth: MIL Spec & Standard
300°F / 149°C DeltaGlass™ Continuous Standard Grade and 500°F / 260°C Continuous (600°F / 315°C Intermittent) High Temperature Grade



- Base material is partially heat treated to remove organics, set the weave dimensionally and reduce fray and loose fibers.
- Meets USCG 164.009 due to low adhesive content.
- Protection from radiant heat. One side is coated with a 1 mil (.001”) thickness aluminum foil. Reflects more than 95% of the radiant heat that contacts its surface. Excellent radiant heat protection from sources such as super-hot metal slabs, proximity to liquid metal, infrared heaters, open flame / plasma or engine exhaust manifolds.
- Available in two temperature ratings based on type of laminating adhesive.
- Used in Marine and nuclear applications as a flange shield material due to its excellent vapor barrier and water/oil resistance.

Meets MIL-C-20079G Type 1 Class 10
Meets MIL-I-24244B / USCG 164.009 / NRC Guide 1.36

The aluminum coating melts at 1220°F / 660°C, however it does take some time for the aluminum to absorb enough heat to melt – thereby it can withstand short exposure to higher temperatures. The base fabric has a rating of 1000°F continuous and higher short term exposure. The 300°F / 149°C Continuous Standard Grade and 500°F / 260°C Continuous (600°F / 315°C Intermittent) High Temperature Grade rating is set by the limit of the laminating adhesive, which will smoke off above the limit. **For applications not requiring the MIL spec material, our most popular Standard grade aluminized fabric is highlighted in yellow in the table below.**

DeltaGlass™ Mil Spec Aluminized Radiant Heat Reflective Protection Fabric				
Part Number	Weight oz/yd²	Thickness in inches	Roll width in inches	Price per Linear Yard
DeltaGlass Aluminum Foil Coated Fiberglass MIL Spec 300°F / 149°C				
F-FG-AL-MIL-2636-20	19.5	.026	36	\$ 38.33
F-FG-AL-MIL-2648-20	19.5	.026	48	\$ 42.71
F-FG-AL-MIL-2660-20	19.5	.026	60	\$ 49.33
DeltaGlass Aluminum Foil Coated Fiberglass MIL Spec 500°F / 260°C				
F-FG-AL-MIL-HT-2636-20	19.5	.026	36	\$ 44.91
F-FG-AL-MIL-HT-2648-20	19.5	.026	48	\$ 49.37
F-FG-AL-MIL-HT-2660-20	19.5	.026	60	\$ 57.64
DeltaGlass Aluminum Foil Coated Fiberglass Standard Grade: 1 yard minimum				
F-FG-AL-RHR-3060-21	21	.030	60	\$ 47.07
F-FG-AL-RHR-6040-35	35	.060	40	\$ 35.88
F-FG-AL-RHRHD-7560-42*	42	.075	60	\$ 66.71

- Full rolls are 50 yards / 150 feet / 45.7 metres long
- Minimum purchase for MIL spec is 15 yards.
- * HD fabric has 3mil thick aluminum foil: our heaviest heat reflective fabric
- PSA adhesive on the back side is available by special order



Aluminum Film Coated Fiberglass Fabric / Cloth

1000°F / 537°C: AluMax™ Poly-Layered High Temperature & Radiant Heat Reflecting



- Comprehensive line of radiant heat reflecting fabrics based on a poly-layered alu structure laminated to fiberglass base substrates. Excellent long-term flexibility.
- Protection from intense radiant heat up to 3000°F.
- Reflects more than 95% of the radiant heat that contacts its surface.
- 3 filament and 3 texturized base materials.
- Excellent radiant heat protection from sources such as super-hot metal slabs, proximity to liquid metal, infrared heaters, open flame / plasma or engine exhaust manifolds is a concern.
- Suitable for workwear fabrication with or without liner materials.

Poly-layered AluMax™ fabric offers protection when radiant heat from infrared sources such as super-hot metal slabs, proximity to liquid metal, open flame/plasma or engine exhaust manifolds is a concern. Constructed from a high-temperature base fabric which is then coated with heat reflective poly-layered aluminum. The base fabric is rated to 1000°F while the radiant capability of the fabric is 3000°F.

AluMax™ Poly-Layered Aluminized Film Radiant Heat Reflective Protection Fabric				
Part Number	Weight oz/yd²	Thickness in inches	Roll width in inches	Price per Linear Yard
Filament Fiberglass Base (plain & satin weave)				
F-FG-ALM-0960-8 (plain weave)	8	.009	60	\$ 56.70
F-FG-ALM-0860-11 (satin weave)	11	.008	60	\$ 61.96
F-FG-ALM-1760-15 (satin weave)	15	.017	60	\$ 62.30
Texturized Fiberglass Base (plain weave)				
F-FG-ALM-2560-12.5 (plain weave)	12.5	.025	60	\$ 49.40
F-FG-ALM-4060-22 (plain weave)	22	.040	60	\$ 52.19
F-FG-ALM-6040-26 (plain weave)	26	.060	40	\$ 57.07

- Full rolls are 50 yards / 150 feet / 45.7 metres long
- This Product is Available By-The-Yard Except Where Indicated
- Discounts for full roll purchases
- PSA adhesive coated on the back side is available

Aluminum Film Coated Fabric Cloth for Protective Clothing Fabrication 750°F / 398°C to 1000°F / 537°C: AluMax™ Poly-Layered High Temperature & Radiant Heat Reflecting



- Comprehensive line of radiant heat reflecting fabrics based on a poly-layered alu structure laminated to aramid, silica, OPAN-Aramid, PBI-Aramid and Carbon fleece base substrates. Excellent long-term flexibility.
- Protection from intense radiant heat up to 3000F.
- Reflects more than 95% of the radiant heat that contacts its surface.
- Excellent radiant heat protection from sources such as super-hot metal slabs, proximity to liquid metal, infrared heaters, open flame / plasma or engine exhaust manifolds is a concern.
- Suitable for workwear fabrication.

Poly-layered AluMax™ fabric offers protection when radiant heat from infrared sources such as super-hot metal slabs, proximity to liquid metal, open flame/plasma or engine exhaust manifolds is a concern. Constructed from a high-temperature base fabric which is then coated with heat reflective poly-layered aluminum. The base fabric has various thermal ratings while the radiant reflecting capability of the fabric is 3000°F.

AluMax™ Aluminized Radiant Heat Reflective Protection Fabric					
Part Number (Base Material)	Base Fabric Temp	Weight oz/yd²	Thickness in inches	Roll width in inches	Price per Linear Yard
F-RHR-5260-13-K (Kove-Aramid) **	750°F / 398°C	13	.052	60	\$ Call
F-RHR-2560-11-PBIK (PB-Aramid)	800°F / 426°C	7.5	.022	60	\$ Call
F-RHR-6560-13-C (Pav-Carbon)	600°F / 315°C	13	.065	60	\$ Call
F-RHR-3960-11-C (Carbon Fleece)	750°F / 398°C	11	.039	60	\$ Call
F-RHR-2560-11-CK (OP-Aramid)	800°F / 426°C	11	.025	60	\$ Call
F-RHR-3038-19-S (Silica) *	1800°F / 982°C	19	.030	38	\$ Call

- ** UL rated for PPE Gloves and other apparel. Meets AATCC-22 & AATCC-35
- This Product is Available By-The-Yard Except Where Indicated
- Discounts for full roll purchases
- * Full 50 yard Rolls Only



Aluminum Flake Impregnated Fiberglass Heat Reflecting Fabric 1000°F / 537°C: AluFlake™ High Temperature & Radiant Heat Reflecting

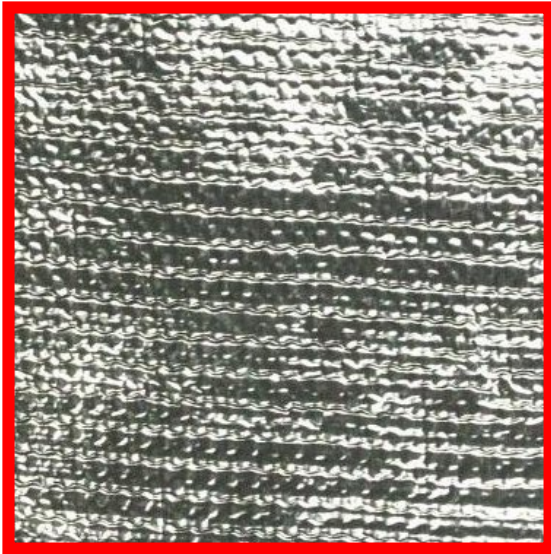

- Radiant heat reflecting fabrics based on an aluminum flake impregnation. Does not crack like aluminum foil coated fabrics and has a higher continuous exposure temperature than aluminum film coated fabrics.
- Protection from intense radiant heat up to 3000°F.
- Reflects more than 95% of the radiant heat that contacts its surface.
- Excellent radiant heat protection from sources such as super-hot metal slabs, proximity to liquid metal, infrared heaters, open flame / plasma or engine exhaust manifolds is a concern.

AluFlake™ Aluminum Impregnated Fiberglass Fabric Radiant Heat Reflective Protection

Part Number	Weight oz/yd ² / g/sq m	Thickness in / mm	Roll width in / mm	Price Linear Yard
F-FG-ALF-1458-12	12 / 340	.014 / 0.60	58 / 1524	\$ 184.68
F-FG-ALF-1258-9	9 / 645	.012 / 1.45	58 / 1016	\$ 103.29
F-FG-ALF-1238-9	9 / 746	.012 / 1.63	38 / 1016	\$ 69.27

- Full rolls are 50 yards / 150 feet / 45.7 metres long
- This Product is also available By-The-Yard
- Discounts apply at 5, 10, 25 and 50 yard purchases

Stainless Steel Coated Fiberglass High Temperature & Radiant Heat Reflective Fabric

1000°F / 537°C: DeltaGlass™



- Protection from intense radiant heat.
- Reflects more than 95% of the radiant heat that contacts its surface.
- A tougher corrosion resistant protection surface than aluminum coated products. Excellent molten splash, weld splatter and grinding spark protection.
- Flexible but much stiffer than aluminum coated fiberglass: sleeves and sleeves with Velcro crease and retain a bent shape when forced into a curve to follow a hose or cable path. Multiple shorter overlapping sections of sleeve reduces the amount of forced bending that may be required.
- Excellent radiant heat protection from sources such as super-hot metal slabs, proximity to liquid metal, infrared heaters, open flame / plasma or engine exhaust manifolds is a concern.

The Stainless Steel foil is calendared to the fiberglass substrate with an adhesive. The temperature limit of this laminate composite fabric is due to the limit of the adhesive material.

DeltaGlass™ Stainless Steel Foil Coated Fiberglass Fabric Radiant Heat Reflective Protection				
Part Number	Weight oz/yd ²	Thickness in inches	Roll width in inches	Price per Yard
F-FG-SS-RHR-3036-34	34	.030	36	\$ 142.03

Call for pricing for sleeve, sleeve with Velcro and tape fabricated from this material.

Maximum continuous temperature exposure for this laminate is 500°F / 260°C, with short term higher exposures. Excellent corrosion resistance. Stainless Steel Foil Thickness: 0.002"

Specifications

Weight:	34/oz/yd ² - 1156 g/m ² (+/- 10%)	ASTM-D-3776-96
Thickness:	0.030 +/- .001" - 0.762 mm +/- .025 mm	ASTM-D-1777-96
Tensile Strength:	Warp 250 lbs/in (44.72 kg/cm) Fill 200 lbs/in (35.72 kg/cm)	ASTM-D-5035-95
Tear Strength:	Warp 50 lbs (22.68 kg) Fill 50 lbs/in (22.68 kg)	ASTM-D-5587-96
Burst Strength	850 psi (59.5 kg/cm ²)	ASTM-D-3786-87
Flame Resistance	Char length 1/16 in max (0.159cm max) Afterglow 1 sec max Flame Out 0 sec max	FED 191/5903.2



Basalt Rock Fiber Cloth Fabric: Premium Grade
1200°F / 648°C: Very High Temperature & Heat Resistant

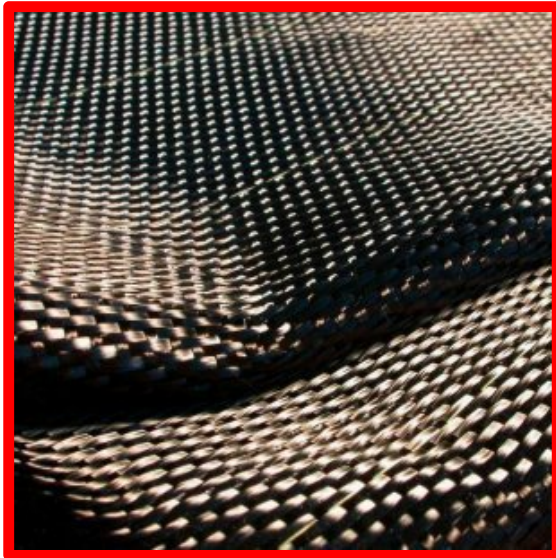

- Manufactured of basalt rock fiber: has a 1200°F / 648°C continuous rating while providing high insulation value & excellent personnel protection.
- Good abrasion resistance and tensile strength.
- Can replace aramid, fiberglass and carbon fibre fabrics.
- Used for many performance auto and motorsport applications due to its ability to handle high exhaust and turbo charger temperatures.
- Has a very shiny black gloss snakeskin appearance.

1200°F / 648°C continuous rating, high insulation value & excellent personnel protection

Very High Temperature & Heat Resistant Basalt Rock Fibre Cloth Roll Fabric				
Part Number	Weight oz/yd ²	Roll Width In / cm	Thickness In / mm	Price per Yard / Metre
F-BRF-00850-6	6	50 / 127	.008 / .20	\$ 70.97 / \$ 77.39
F-BRF-2550-19	19	50 / 127	.025 / .64	\$ 104.90 / \$ 114.34
F-BRF-2550-20	20	50 / 127	.025 / .64	\$ 123.70 / \$ 134.83

Roll length is 150 Feet / 50 yards / 45 Metres. Please call for pricing on fabric with PSA

These Products are Available By-The-Yard / Metre: Discounts for full roll purchases

Silica/Fiberglass Blend Fabrics: *Premium Grade*
ProSil™ Plain fabric and ProSilMax™ Wire re-enforced fabric
1350°F / 723°C: Very High Temperature & Heat Resistant

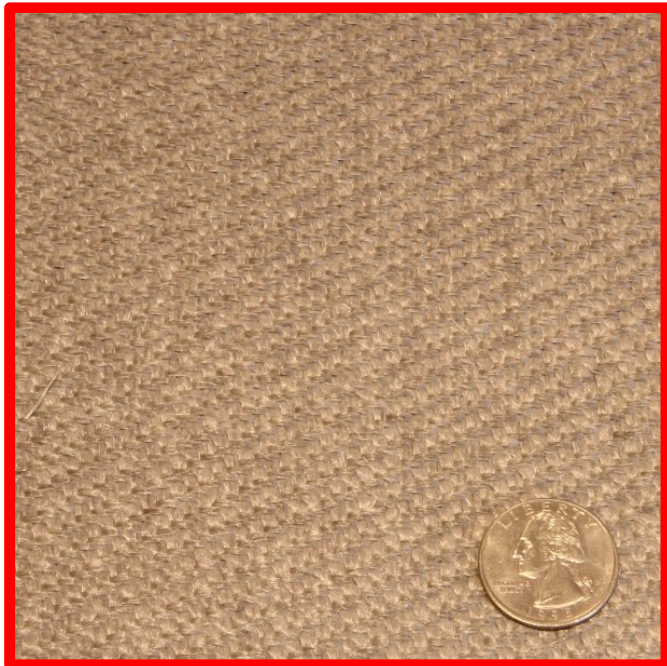

- Fabric has a 1350°F / 723°C continuous rating while providing high insulation value & excellent personnel protection.
- Very good abrasion resistance and tensile strength.
- ProSilMax version is Inconel wire reinforced.
- Remains soft, and pliable and conformable at temperatures where fiberglass materials become brittle.

1350°F / 723°C continuous rating, high insulation value & excellent personnel protection

Very High Temperature & Heat Resistant HTC Fiberglass Cloth Roll Fabric				
Part Number	Weight oz/yd²	Roll Width In / cm	Thickness In / mm	Price per Yard / Metre
F-PROSIL-3236-18	18	36 /	.032 / 0.81	\$ 30.16 / \$ 98.92
F-PROSIL-3260-18	18	60 / 152	.032 / 0.81	\$ 41.63 / \$ 136.54
F-PROSIL-4560-26	26	60 / 152	.045 / 1.14	\$ 56.50 / \$ 185.32
F-PROSILMAX-7060-35	35	60 / 152	.070 / 1.77	\$ 71.63 / \$ 234.94

Roll length is 150 Feet / 50 yards / 45 Metres. Please call for pricing on fabric with PSA

These Products are Available By-The-Yard / Metre:

Discounts at 5, 10, 25 and 50 yard purchases

S-Glass Fiberglass: Premium Grade

1400°F / 760°C: Very High Temperature & Heat Resistant



- S-Glass Fiberglass has a 1400°F / 760°C continuous rating while providing high insulation value & excellent personnel protection.
- Very good abrasion resistance and tensile strength.
- S-Glass is a stronger and stiffer version of E-Glass and a higher modulus of elasticity (improved impact resistance over E-glass).
- S-Glass fabric is a very bright white color.

1400°F / 760°C continuous rating, high insulation value & excellent personnel protection

Very High Temperature & Heat Resistant S-Glass Fiberglass Cloth Roll Fabric				
Part Number	Weight oz/yd ²	Roll Width In / cm	Thickness In / mm	Price per Yard / Metre
F-SFG-3260-19	19	60 / 152	.032 / .81	\$ 171.63 / \$ 187.08

Roll length is 150 Feet / 50 yards / 45 Metres. Please call for pricing on fabric with PSA

These Products are Available By-The-Yard / Metre:

Discounts at 5, 10, 25 and 50 yard purchases



Vermiculite Coated Fiberglass Cloth Fabric (Fireblanket)
1500°F / 815°C: FlameShield™ 1500 VC Very High Temperature & Heat Resistant



Manufactured of texturized fiberglass yarns, this fabric has a 1500°F / 815°C continuous rating while providing high insulation value & excellent personnel protection. Coated with vermiculite for higher temperature performance and added abrasion resistance.

Certified to meet the requirements of ASTM E 162, ASTM E 662 & SMP 800-C for surface flammability, smoke and toxic gas generation. Meets Federal Railroad Administration requirements for surface flammability and rate of smoke generation

Good abrasion resistance and tensile strength.

Available with PSA (pressure sensitive adhesive*).

1500°F / 815°C continuous rating, high insulation value & excellent personnel protection

A high-performance extreme-temperature fabric, used in almost all industries for the highest heat protection available

DeltaGlass™ VC Very High Temperature & Heat Resistant Vermiculite Coated Fiberglass Cloth / Fabric / Fireblanket				
Part Number	Weight oz/yd²	Roll Width In / cm	Thickness In / mm	Price per yard
F-FG-VC-2060-10	10	60 / 152	.020 / 0.51	\$ 23.71
F-FG-VC-6040-24	24	40 / 101	.060 / 1.52	\$ 38.88
F-FG-VC-6060-24	24	60 / 152	.060 / 1.52	\$ 54.00
F-FG-VC-6540-30	30	40 / 101	.065 / 1.65	\$ 43.74
F-FG-VC-6560-30	30	60 / 152	.065 / 1.65	\$ 63.56
F-FG-VC-7540-36	36	40 / 101	.075 / 1.91	\$ 47.31
F-FG-VC-7560-36	36	60 / 152	.075 / 1.91	\$ 84.83
F-FG-VC-9040-40	40	40 / 101	.090 / 2.29	\$ 50.94
F-FG-VC-9060-40	40	60 / 152	.090 / 2.29	\$ 90.63
F-FG-VC-12540-64	64	40 / 101	.125 / 3.18	\$ 98.72
F-FG-VC-12560-64	64	60 / 152	.125 / 3.18	\$ 164.64
** F-FG-VC-3560-20	20	60 / 152	.035 / 0.89	\$40.50

Roll length is 50 yards / 45 Metres. Please call for pricing on fabric with PSA

**VCFCB cloth has a very high vermiculite content (10 to 12%). Allows for short term exposure to 2000°F and exceptional abrasion resistance.

* Note: The PSA will burn off at temperatures above 400°F and should be used to facilitate installation. Material with PSA should not be used in confined areas at elevated temperatures without ventilation until all of the PSA has vaporized.

This Product is Available By-The-Yard: Discounts for full roll purchases



Silica Cloth with one side silicone rubber coating: Medium duty
1800°F / 982°C: InSilMax™ with 500°F / 260°C: FlameShield™ Silicone Rubber
Coating - High Temperature, Heat & Flame Resistant
Molten Metal SplashGuard™ / Fire Blanket / Welding Blanket / Curtains-Shields



- *Coated on one side: total weight 50 oz/yd²*
- *Makes excellent molten metal splash, welding splatter, plasma spray & grinding spark shields and curtains*
- *Robotic welding arm and elbow covers & cable protectors*
- *Plasma cutting head splatter protection*
- *Silicone rubber coating provides anti-fray and mounting/fastening options. Use with silicone coating side mounted towards splatter/splash source but mounted away from higher dry heat source for longer product life.*

InSilMax™ one side silicone rubber coated high temperature Silica fabric					
Part Number	Weight Linear foot / oz/yd²	Roll Width In / cm	Thickness In / mm	Price per Yard	Price per Metre
F-S-SR1-6336-50*	1.10 lbs / 50	36 / 91	0.063 / 1.60	\$ 144.41	\$ 157.84

The color of this fabric is oxide-red
 available in 50 yard rolls

Heavy Duty 50 oz/yd² and other lighter fabrics and 2 side coated fabrics are used as high temperature curtains and shields, weld splatter and pyro resistant sleeves and jackets, weather or spray-down / wash-down resistant high temperature fabric for making protective covers, sleeves, jackets. Very good molten metal splash protection.

Coated fabrics provide excellent cold temperature performance with flexibility to -76°C for refrigeration and cryogenic applications. These materials can be easily used to make shield and covers that are assembled with mechanical fasteners. Easily punched or drilled for installation of grommets, or insertion of sheet metal screws or bolts.

This Product is Available By-The-Yard / Metre: Discounts for full roll purchases
Custom Slitting to Any Width Available

Silica Cloth Fabric FireBlanket-weld protection blanket 1800°F / 982°C: InSilMax™ Extreme High Temperature, Heat, Flame, Molten Metal & Weld Splatter / Slag / Spark Resistant



- An alternative to asbestos and ceramic based textiles.
- Highly flexible and minimal shrinkage.
- High abrasion resistance and tensile strength.
- Melts above 3000°F / 1648°C.
- Produced from an extremely pure base fiber and can be used at 1800°F / 982°C continuously with excursions to 3000°F / 1650°C.
- InSilMax provides burn-through protection from molten metal and weld splatter/slag/sparks.
- A high-performance extreme-temperature fabric, used in almost all industries for the highest heat protection available.

1800°F / 982°C continuous rating, high insulation value & excellent personnel protection

InSilMax™ Extreme Temperature Silica Cloth Fabric				
Part Number	Weight oz/yd²	Roll Width In / cm	Thickness In / mm	Price per yard / metre
F-S-2836-18	18	36 / 91	.028 / .71	\$ 35.13 / \$ 38.29
F-S-3036-18 (satin weave)	18	36 / 91	.030 / .76	\$ 39.00 / \$ 42.51
F-S-3060-18 (satin weave)	18	60 / 152	.030 / .76	\$ 72.12 / \$ 78.61
F-S-5436-36 (satin weave)	36	36 / 91	.054 / 1.4	\$ 68.48 / \$ 74.64
F-S-5460-36 (satin weave)	36	60 / 152	.054 / 1.4	\$ 123.20 / \$ 134.29
F-S-6540-32	32	40 / 101	.065 / 1.6	\$ 128.60 / \$ 140.17
F-S-8540-38	38	40 / 101	.085 / 2.2	\$ 151.13 / \$ 164.74
F-S-9038-40	40	38 / 96	.090 / 2.3	\$ 96.08 / \$ 104.73
F-S-9060-40	40	60 / 152	.090 / 2.3	\$ 136.24 / \$ 148.50
F-S-11540-50	50	40 / 101	.115 / 2.9	\$ 139.70 / \$ 152.27

InSilMax™ Extreme Temperature Silica Cloth Fabric with Vermiculite Coating – Sold Full Roll Only				
Part Number	Weight oz/yd²	Roll Width In / cm	Thickness In / mm	Price per yard / metre
F-S-VC-2840-18 *	18	40 / 101	.028 / 0.71	\$ 38.63 / \$ 42.11
F-S-VC-6540-33	33	40 / 101	.065 / 1.65	\$ 146.37 / \$ 159.54
F-S-VC-9540-42	42	40 / 101	.095 / 2.4	\$ 168.97 / \$ 184.17
F-S-VC-12540-55	55	40 / 101	.125 / 3.2	\$ 184.78 / \$ 201.40

Vermiculite coating adds abrasion resistance and adds significantly to the fabric's durability.
 * Coating on this item is light duty.

These products are available in 150 foot / 50 yard / 45.8 metre rolls

Items highlighted in yellow are FM Approval Class 4950 – Meets MIL-I-24244 & MIL-C-24576(SH) specifications

**These Products are Available By-The-Yard / Metre Except as Indicated
 Discounts for full roll purchases**



Silica Cloth Fabric – Fireblanket

1900°F / 1037°C: InSilMax™ XT Extreme High Temperature, Heat, Flame, Molten Metal & Weld Splatter Resistant



- An alternative to asbestos and ceramic based textiles.
- Highly flexible and minimal shrinkage.
- High abrasion resistance and tensile strength.
- Melts above 3000°F / 1648°C.
- Produced from an extremely pure base fiber and can be used at 1900°F / 1037°C continuously with excursions to 3000°F / 1650°C.
- InSilMax provides burn-through protection from molten metal and weld splatter.
- A high-performance extreme-temperature fabric, used in almost all industries for the highest heat protection available

1900°F / 1037°C continuous rating, high insulation value & excellent personnel protection

InSilMax™ XT Extreme Temperature Silica Cloth Fabric				
Part Number	Weight oz/yd²	Roll Width In / cm	Thickness In / mm	Price per yard / metre
F-S-XT-2836-18	18	36 / 91	.028 / .71	\$ 40.40 / \$ 44.03
F-S-XT-3036-18	18	36 / 91	.030 / .76	\$ 44.85 / \$ 48.89
F-S-XT-3060-18	18	60 / 152	.030 / .76	\$ 82.94 / \$ 90.40
F-S-XT-5436-24	24	36 / 91	.054 / 1.4	\$ 78.75 / \$ 85.84
F-S-XT-5460-24	24	60 / 152	.054 / 1.4	\$ 141.68 / \$ 154.43
F-S-XT-6540-32	32	40 / 101	.065 / 1.6	\$ 147.89 / \$ 161.19
F-S-XT-8540-38	38	40 / 101	.085 / 2.2	\$ 173.80 / \$ 189.45
F-S-XT-9038-40	40	38 / 96	.090 / 2.3	\$ 110.49 / \$ 120.44
F-S-XT-9060-40	40	60 / 152	.090 / 2.3	\$ 156.68 / \$ 170.78
F-S-XT-11540-50	50	40 / 101	.115 / 2.9	\$ 160.67 / \$ 175.11

InSilMax™ XT Extreme Temperature Silica Cloth Fabric with Vermiculite Coating – Sold Full Roll Only				
Part Number	Weight oz/yd²	Roll Width In / cm	Thickness In / mm	Price per yard / metre
F-S-XT-VC-2840-18 *	18	40 / 101	.028 / 0.71	\$ 44.43 / \$ 48.42
F-S-XT-VC-6540-33	33	40 / 101	.065 / 1.65	\$ 168.32 / \$ 183.47
F-S-XT-VC-9540-42	42	40 / 101	.095 / 2.4	\$ 194.32 / \$ 211.80
F-S-XT-VC-12540-55	55	40 / 101	.125 / 3.2	\$ 267.30 / \$ 291.35

Vermiculite coating adds abrasion resistance and adds significantly to the fabric's durability.
 * Coating on this item is light duty.

These products are available in 150 foot / 50 yard / 45.8 metre rolls

**These Products are Available By-The-Yard / Metre Except as Indicated
 Discounts for full roll purchases**

Alumina Cloth Fabric

2300°F / 1260°C: AluMax™ Extreme High Temperature, Heat, Flame, Molten Metal & Weld Splatter Resistant



- An alternative to asbestos and ceramic based textiles.
- Highly flexible and minimal shrinkage.
- High abrasion resistance and tensile strength.
- Melts above 3000°F / 1648°C.
- Produced from an extremely pure base fiber and can be used at 2300°F / 1260°C continuously with excursions to 3000°F / 1650°C.
- AluMax provides burn-through protection from molten metal and weld splatter.
- A high-performance extreme-temperature fabric, used in almost all industries for the highest heat protection available

2300°F / 1260°C continuous rating, high insulation value & excellent personnel protection

AluMax™ Extreme Temperature Fabric Alumina Cloth Blanket				
Part Number	Weight oz/yd²	Roll Width In / cm	Thickness In / mm	Price per yard / metre
F-ALUMINA-1940-14	14	40 / 101	.019 / .48	\$ 521.44 / \$ 568.37
F-ALUMINA-3840-20	20	40 / 101	.038 / .96	\$ 488.74 / \$ 532.73

These products are available in 150 foot / 50 yard / 45.8 metre rolls

Full roll purchase only



Ceramic Fiber Paper

2000°F / 1093°C: CerMax™ Extreme High Temperature, Heat & Flame Resistant: Premium Grade



- An alternative to asbestos.
- Light-weight, flexible, good handling strength
- Low thermal conductivity, good dielectric strength
- Excellent corrosion resistance
- Can be die-cut or stamped
- Produced from an extremely pure aluminosilicate ceramic fiber non woven fabric.
- Can be used at 2000°F / 1093°C continuously, with peaks to 2300°F / 1260°C. Melts above 3000°F.

2000°F / 1093°C continuous rating, high insulation value & excellent personnel protection

CerMax™ Extreme High Temperature, Heat & Flame Resistant Ceramic Fiber Compressed Mat Paper: Premium Grade					
Part Number	Thickness in / mm		Feet per Roll	Roll Width in / cm	Price per yard
F-C-CMP-03124	.031	0.8	200	24 / 60.9	\$ 18.72
F-C-CMP-06224	.062	1.6	100	24 / 60.9	\$ 21.17
F-C-CMP-06248	.062	1.6	125	48 / 121.9	\$ 31.68
F-C-CMP-12548	.125	3.2	62.5	48 / 121.9	\$ 49.44
F-C-CMP-25048	.250	6.4	33	48 / 121.9	\$ 57.48

Technical Specifications

Density: 10 lb/cu ft
 Chemical Composition: Al₂O₃ 47%; Total Al₂O₃ and SiO₂ > 97% Fe₂O₃ <1.0%
 Tensile Strength: 25 lbs
 Thermal Conductivity: 500°F: 0.38 (0.05); 1000°F: 0.61 (0.09); 1500°F: 0.94 (0.14);
 BTU in/hr ft² (w/m²*k) 2000°F: 1.40 (0.20)

Resistant to most chemicals except hydrofluoric, phosphoric acids and concentrated alkalis.

This product may have some minor edge compression extending to a few inches due to shipping shift and handling. This is normal and unavoidable due to the low relative tensile strength of this product.

**The 48 inch wide products are available By-The-Yard
 Discounts for full roll purchases**

Ceramic Fibre Cloth Fabric
2300°F / 1260°C: CerMax™ Extreme Temperature Premium Grade



- An alternative to asbestos based textiles.
- Highly flexible and minimal shrinkage.
- High abrasion resistance and tensile strength.
- Melts above 3000°F / 1648°C.
- Highest purity ceramic fibre.

This is a high-performance extreme-temperature fabric, used in almost all industries for the highest heat protection available.

2300°F / 1260°C continuous rating, high insulation value & excellent personnel protection

CerMax™ Extreme High Temperature +Plus, Heat & Flame Resistant Premium Ceramic Fibre Blanket Cloth Fabric				
Part Number	Weight oz/yd²	Roll Width In / cm	Thickness In / mm	Price per roll
1/16" / .0625" / 1.6mm Thick				
F-C-P-06236-22-1-IWI*	22	36 / 91	.0625 / 1.6	\$ 1593.21
F-C-P-06236-21-1-FGI**	21	36 / 91	.0625 / 1.6	\$ 1442.67
1/8" / .125" / 3.2mm Thick				
F-C-P-12536-43-2-IWI*	43	36 / 91	.125 / 3.2	\$ 2233.00
F-C-P-12536-41-2-FGI**	41	36 / 91	.125 / 3.2	\$ 2046.25

* This material contains an inconel wire insert
 ** This material contains a glass filament insert

This product is available in 16.6 yard / 50 foot rolls

This Product is NOT Available By-The-Yard: Discounts for full roll purchases



Ceramic Fibre Cloth Fabric: *Industrial Grade*
2300°F / 1260°C: CerMax™ Extreme Temperature +Plus



- An alternative to asbestos based textiles.
- Highly flexible and minimal shrinkage.
- High abrasion resistance and tensile strength.
- Melts above 3000°F / 1648°C.

This is a high-performance extreme-temperature fabric, used in almost all industries for the highest heat protection available.

2000°F / 1260°C continuous rating, high insulation value & excellent personnel protection

CerMax™ Extreme High Temperature +Plus, Heat & Flame Resistant Premium Ceramic Fibre Blanket Cloth Fabric					
Part Number	Weight oz/yd²	Roll Width In / cm	Thickness In / mm	Price per roll	Price per yard
1/16" / .0625" / 1.6mm Thick					
F-C-I-06236-22-1-IWI*	22	36 / 91	.0625 / 1.6	\$ 806.25	\$ 67.16
F-C-I-06236-21-1-FGI**	21	36 / 91	.0625 / 1.6	\$ 925.66	\$ 77.08
1/8" / .125" / 3.2mm Thick					
F-C-I-12536-43-2-IWI*	43	36 / 91	.125 / 3.2	\$ 1067.50	\$ 88.91
F-C-I-12536-41-2-FGI**	41	36 / 91	.125 / 3.2	\$ 1083.30	\$ 90.25

This product is available in 33 yard / 99 foot rolls

- * This material contains an inconel wire insert
- ** This material contains a glass filament insert

This Product is Available By-The-Yard

CerMax Fabric Technical Data

CerMax is alumino-silicate based refractory fiber. White and odorless. Available with either a fiberglass or wire re-inforcement. Some organic binder is present, and will smoke-off at elevated temperatures. Once the organics have smoked-off, the product will turn white again. If smoke free operation is required, then it should be heat treated before use.

Chemical & Physical Data: Total Al_2O_3 and SiO_2 > 97% (Al_2O_3 : 47%); Fe_2O_3 <1.1%. Weight Loss (1800°F) 8-10%; Refractory Fiber content >85%. Fiber diameter: 2 - 4 microns; Fiber length: 100 - 250 mm. Fiber shrinkage (1800°F, 3 hr) <3.5%

Thermal Conductivity: 570°F: 0.84 BTU/ft² °F/in (0.12 W/m °K). 1100°F: 0.91 BTU/ft² °F/in (0.13 W/m °K). 1800°F: 1.19 BTU/ft² °F/in (0.17 W/m °K).



Flexible Graphite Sheets and Rolls 950°F / 510°C to 5400°F / 2982°C: GraphTek™



- Plain or reinforced sheets, laminates and rolls.
- Available with 316 Stainless Steel Foil Insert, Tang Insert, 316 Stainless Steel Wire Insert, Mylar Insert
- Flexible Graphite is 99% Carbon, providing extreme heat protection, thermal dissipation, lubrication but not electrical conductivity. Made from mineral (flake) graphite it is non metallic, but thermally and electrically conductive just like metals.
- Sheets are 39.4 inches x 39.4 inches and are cut from roll material.
- Premium grade has low sulphur content.

Service temperature range depends on surrounding conditions. Useable to 950°F / 510°C in an oxidizing atmosphere (standard air). Useable to 1500°F / 815°C in mild oxidizing or steam atmosphere and useable to 5400°F / 2982°C in non-oxidizing conditions.

GraphTek™ Flexible Homogeneous Graphite Sheet Roll					
Part Number	Thickness in inches/mm	"A" 39.4" x 108' roll	"B" 39.4" x 39.4" Sheet	"C" 60" x 200' roll	"D" 5" x 108' roll
F-GR-005-X	.005 / .127	\$ 182.50	\$ 56.25	NA	NA
F-GR-010-X	.010 / .254	\$ 221.25	\$ 63.75	NA	NA
F-GR-015-X	.015 / .381	\$ 260.00	\$ 73.75	\$ 635.00	NA
F-GR-020-X	.020 / .508	\$ 338.75	\$ 85.00	\$ 1005.00	\$ 48.75
F-GR-030-X	.030 / .762	\$ 492.50	\$ 107.50	NA	\$ 68.75
F-GR-040-X	.040 / 1.016	\$ 595.00	\$ 131.25	NA	NA

GraphTek Flexible Homogeneous Graphite Sheet Roll Premium Grade					
F-GR-P-015-X	.015 / .381		\$ 607.50	NA	NA
F-GR-P-0625-X	.0625 / 1.587		\$ 1316.25	NA	NA

GraphTek Flexible Graphite Laminate Sheet: 39.4" x 39.4"					
F-GR-316SS Foil		NA	\$ Call	NA	NA
F-GR-316SS-Tang		NA	\$ Call	NA	NA
F-GR-316SS-Wire		NA	\$ Call	NA	NA
F-GR-Mylar		NA	\$ Call	NA	NA
F-GR-Carbon Steel		NA	\$ Call	NA	NA

For the "X" value, Specify A, B, C or D in part number to correspond to the desired size

Due to the nature of graphite sheet materials, additional protective packaging is required for shipping. A \$15.00 special packaging fee is charged for all GraphTek products. Sheet products also incur an extra oversize fee from UPS when shipped (typically \$8.00).

Knitted Stainless Mesh Fabric 1200°F / 648°C & 2300°F / 1260°C 304 Stainless Steel & Inconel

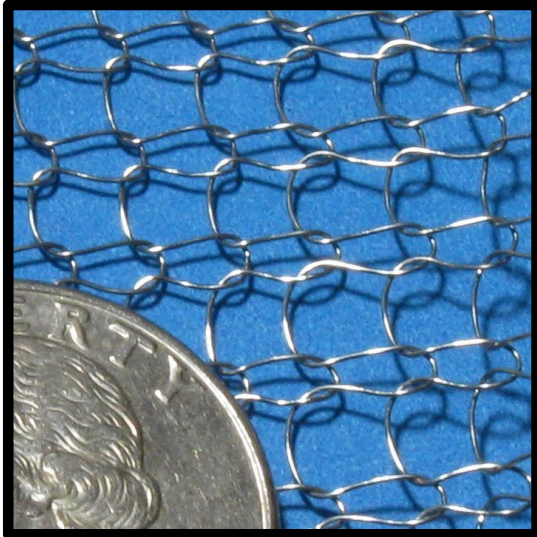

- 304 Stainless Steel Knitted Mesh. Fabricated from using .011" diameter wire.
- Inconel Knitted Mesh is fabricated from .008" diameter wire.
- Used to support needed insulation blanket and felt in fabricated exhaust system removable blankets or to overwrap into place other high temperature blankets to hold in place onto a vessel or pipe.
- Many other uses where a guard or other protective aperture is required in hot applications.
- Knit Mesh allows two way stretch; unlike woven mesh.

Stainless Steel Knit Mesh is useable to 1200°F / 648°C.
 Inconel Knit Mesh is useable to 2300°F/1260°C.

Knitted Mesh Fabric: 304 Stainless Steel & Inconel				
Part Number	Material	Weight oz/yd ²	Roll width in inches	Price per Yard
F-SSMF-30	Stainless Steel	11	30"	\$ 27.67
F-SSMF-42	Stainless Steel	11	42"	\$ 32.48
F-ISMF-30	Inconel	10	30"	\$ 193.57

Rolls are produced as 50 pound roll: Approximately 13 sq ft/pound.
 Roll Length is approx 43 yards for 30" wide roll and 30 yards for 42" wide roll.

This knitted mesh is produced as a tubular sleeve: and when rolled flat it is therefore a "double layer" of mesh, which users typically cut open to use as a single layer in their applications. The 30" width when cut open is 60" wide and the 42" roll when cut open is 84" wide.

Other knit mesh materials are available by special order: Plain Steel, Galvanized Steel, Aluminum, Copper, Tinned Copper, Inconel, Monel, Tungsten, Tantalum, Platinum, Gold Alloy, Gold Plated Copper, Silver Plated Copper, Polypropylene, Polyethylene, Nylon.

Insulation Materials

DeltaMax™ Silicone Foam Insulation Substitute	5-1
PyroTecton™ Needled Nomex® Insulation Felt	5-2
PyroTecton™ Needled Kevlar® Insulation Felt	5-3
DeltaMax™ Needled Fiberglass Felt / Batt	5-4
InSilMax™ Needled Silica Felt / Batt	5-5
InSilMax™ XT Needled Silica Felt / Batt	5-6
InSilSafe™ Needled Vitreous Silicate Felt / Batt	5-7
Needled Ceramic Fiber Felt / Batt	5-8



High Temperature
DeltaMax™ Silicone Foam
Insulation Page 5-1



High Temperature DeltaMax™
Meta & Para Aramid Insulation Felts
Page 5-2

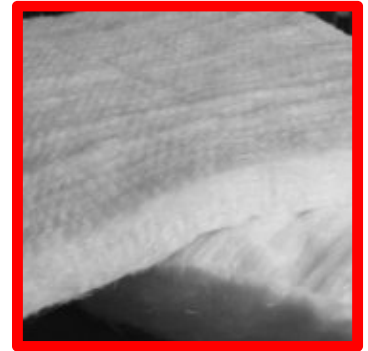

Very High Temperature
DeltaMax™ Needed
Fiberglass Insulation Page 5-4

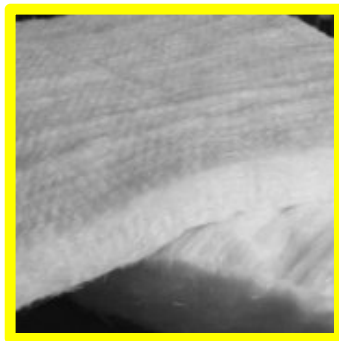

InSiMax™ Extreme Temperature
Silica Insulation. Page 5-5



InSiMax™ XT Extreme Temperature
Silica Insulation. Page 5-6



Extreme Temperature
CerMax™ Fibre Insulation
Page 5-7



InSiSafe™ XT Extreme Temperature
Vitreous Silicate Insulation. Page 5-8



Silicone Sponge Foam - Closed Cell - Roll & Sheet
Low Thermal Conductivity Insulation
428°F / 220°C: DeltaMax™ High Temperature & Heat Resistant

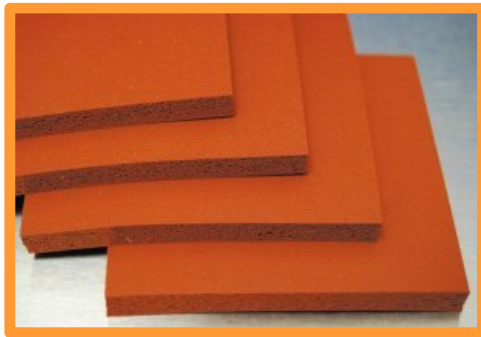

- Thermal insulation sponge. Available in .250" and .500" thick (+/- .025).
- General purpose sponge is red in color. UL94 V-0 flame resistant is grey in colour.
- Compression deflection at 25% is 12.5 psi.
- Water absorption is 5% maximum, typically 1% measured.
- Thermal conductivity 0.110 W/mK.
- Specific Gravity 0.5
- Operating temperature -50°C to 230°C
- Compression set at 100°C (22 hours) - <20%
- Tensile Strength >100psi
- Elongation - >300%
- Ply adhesion to > 3 lbs/in
- Total mass loss, 125°C, 24 hrs, vacuum - <1%
- Tensile strength retention (250°C 3 days) - >70%
- Elongation retention (250°C 3 days) - >30%

Silicone Sponge Rubber Foam - General Purpose and also UL94 V-0 rated								
Part Number	Thickness		Color	Roll Width *		Roll Length		Price per yard
	in	mm		in	cm	ft	m max	
IM-SSR-R-4	.250	6.35	Red	46	116.84	150	45.72	\$ 324.43
IM-SSR-R-8	.500	12.7	Red	42	106.68	120	36.57	\$ 447.37
IM-SSR-G-UL94-4	.250	6.35	Grey	46	116.84	150	45.72	\$ 403.64
IM-SSR-G-UL94-8	.500	12.7	Grey	42	106.68	120	36.57	\$ 517.17

Minimum order is 3 yards. -5% for roll lengths of 10, 20 or 30 yards. -15% for 50 yards

* Useable width is typically 2 inches less than roll width

Meta Aramid Nomex[®] Insulation Felt 450°F / 230°C PyroTection[™] High Temperature Insulation and Protection Heat Resistant Nomex[®]



- Can be used as an insulation.
- Can be used for filtration.
- Can be as a protection pad in hot processes to prevent marking of products.
- Coatings and PSA's available.
- Resin impregnated available to increase stiffness.
- Roll lengths up to 100metres / 328 feet available on thinner materials. Shorter roll length on thicker materials.

These needed pads can be used as insulation or protection in hot processes to prevent marking of products as they exit various drying/curing ovens.

PyroTection [™] Felts - High Temperature & Flame Resistant Nomex [®]								
230°C / 450°F Operating Temperature - 400°C / 750°C decomposition temperature								
Part Number	Thickness in / mm		Weight oz/yd ² / g/m ²		Roll Width in / cm		Roll Length Yards	Price per yard / metre
Nomex [®] - color is off white								
IM-N-F-8082-10	.080	2.0	10	339	82	208	109	\$ 45.28
IM-N-F-8082-14	.080	2.0	14	474	82	208		Call
IM-N-F-11082-6.5	.110	2.8	6.5	220	82	208	109	\$ 67.20
IM-N-F-16082-7.5	.160	4.1	7.5	254	82	208		Call
IM-N-F-25082-14	.250	6.3	14	474	82	208		Call
IM-N-F-50072-53	.500	12.7	53	1797	72	182		Call
With Resin Stiffener								
IM-N-F-7082-14R	.070	1.7	14	474	82	208		Call
IM-N-F-11082-15R	.110	2.8	15	508	82	208		Call
IM-N-F-19072-28R	.190	4.8	28	949	72	182	55	\$ 180.37
IM-N-F-30072-53R	.300	7.6	53	1797	72	182	55	\$ 316.15

Para Aramid Kevlar® Insulation Felt
840°F / 450°C PyroTection™ High Temperature Insulation and Protection
Heat Resistant Kevlar®



- Can be used as an insulation.
- Can be as a protection pad in hot processes to prevent marking of products.
- Coatings and PSA's available.
- Resin impregnated available to increase stiffness.
- Roll lengths up to 100metres / 328 feet available on thinner materials. Shorter roll length on thicker materials.

These needed pads can be used as insulation or protection in hot processes to prevent marking of products as they exit various drying/curing ovens.

PyroTection™ Felts - High Temperature & Flame Resistant Kevlar® / Kevlar-Nomex Blend / Kevlar-Polyester Layered 450°C / 840°F Operating Temperature - 525°C / 975°C decomposition temperature								
Part Number	Thickness in / mm		Weight oz/yd ² / g/m ²		Roll Width in / cm		Roll Length yards	Price per yard
Kevlar® - color is yellow								
IM-K-F-0440-3.2	.04	1.0	3.2	108	40	101		Call
IM-K-F-0563-5.5	.05	1.3	5.5	186	63	160	109	\$ 40.23
Kevlar - Nomex Blend								
IM-K/N-F-16066-32	.16	4.1	32	1084	66	167	109	\$ 192.26
With Resin Stiffener								
IM-K-F-19083-38R	.190	4.8	38	1288	83	210	109	\$ 416.27
IM-K-F-48079-95R	.480	12.2	95	3221	79	200	44	\$ 1146.20

Needed Fiberglass Insulation Felt / Matt / Batt
1200°F / 648°C: DeltaMax™ Very High Temperature, Heat and Flame Resistant
Premium Grade



- Excellent insulation for sandwiching between front and rear (hot and cold side) layers of blankets & curtains.
- Non-flammable.
- Conforms to MIL-I-16411 Type II.
- Meets US Coast Guard 164.009 for incombustible materials.
- Meets MIL-I-24244 for corrosiveness.
- Thermal conductivity of .43 at 500°F and .53 at 649°F.

1200°F / 648°C continuous rating, high insulation value

Needed fiberglass insulation felt / matt / batt is manufactured from 100% non-woven E-type fiberglass textile fibers. It is used in a variety of applications and specifically designed for use in aerospace, automotive, construction and industrial applications due to its low corrosiveness (meeting MIL-I-24244).

Used extensively in the production of removable pads for welding stress relieving, furnace and oven wall gap insulation, removable pipe insulation, gas and steam turbine power generating equipment blankets, etc.

Very High Temperature, Heat and Flame Resistant Needed Fiberglass Insulation Felt / Matt / Batt: Premium Grade									
Part Number	Thickness		Density		Roll Width		Roll Length		Price per Yard / Metre
	in	mm	lbs/ft ³	kg/m ³	in	cm	ft	m	
IM-FG-NEEDED-0.25	¼	7	9	144	60	152	150	45.7	\$ 25.20 / \$ 27.47
IM-FG-NEEDED-0.50	½	13	9	144	60	152	75	22.8	\$ 35.40 / \$ 38.59
IM-FG-NEEDED-0.75	¾	19	11	176	60	152	45	13.7	\$ 42.69 / \$ 46.67
IM-FG-NEEDED-1.00	1	25	11	176	60	152	45	13.7	\$ 49.98 / \$ 54.48

Weight: 0.25 = 3oz/ft²; 0.50 = 6oz/ft²; 0.75 = 12oz/ft²; 1.00 = 15oz/ft²

This Product is Available By-The-Yard / Metre

Silica Insulation Felt / Matt / Batt - Industrial Grade
1800°F / 982°C: InSilMax™ Extreme High Temperature
Heat Flame Resistant



- An alternative to asbestos and ceramic based insulation materials.
- Highly flexible and minimal shrinkage.
- Melts above 3000°F / 1648°C.
- Produced from an extremely pure base fiber (SiO₂) and can be used at 2000°F / 1093°C continuously with excursions to 3000°F / 1650°C.

This Insulation is a needled blanket manufactured from amorphous silica. This material is an excellent alternative to Refractory Ceramic Fiber (RCF) or asbestos.

It is used in a variety of applications and specifically designed for use in aerospace, automotive, construction and industrial applications. Specific applications include: removable pads, furnace and oven insulation, pipe insulation, power generating equipment plus many more.

InSilMax™ Extreme High Temperature Heat & Flame Resistant Insulation									
Part Number	Thickness in / mm		Density lbs/ft ³ / kg/m ³		Roll Width in / cm		Roll Length ft / m		Price per roll
IM-S-NEEDED-M003-02	1/8	3	8	144	36	91	130	39	\$ 1437.00
IM-S-NEEDED-M007-04	¼	7	10	180	36	91	99	30	\$ 1738.00
IM-S-NEEDED-M013-08	½	13	10	180	36	91	49	15	\$ 1732.00
IM-S-NEEDED-M025-16	1	25	10	180	36	91	25	7.6	\$ 1761.40

PRICING NOTE: DUE TO VOLATILITY IN RAW MATERIAL COSTS THE PRICING ON THIS PRODUCT MAY INCUR A SURCAHRGE AT TIME OF ORDERING

This Product is NOT Available By-The-Foot – Full Roll Only

Silica Insulation Felt / Matt / Batt - Premium High Purity
2000°F / 1093°C: InSilMax™ XT Extreme High Temperature
Heat Flame Resistant



- An alternative to asbestos and ceramic based insulation materials.
- Highly flexible and minimal shrinkage.
- Melts above 3000°F / 1648°C.
- Produced from an extremely pure base fiber (SiO₂) and can be used at 2000°F / 1093°C continuously with excursions to 3000°F / 1650°C.

This Insulation is a needled blanket manufactured from amorphous silica. This material is an excellent alternative to Refractory Ceramic Fiber (RCF) or asbestos.

It is used in a variety of applications and specifically designed for use in aerospace, automotive, construction and industrial applications. Specific applications include: removable pads, furnace and oven insulation, pipe insulation, power generating equipment plus many more.

InSilMax™ XT Extreme High Temperature Heat & Flame Resistant Insulation									
Part Number	Thickness in / mm		Density lbs/ft ³ / kg/m ³		Roll Width in / cm		Roll Length ft / m		Price per roll
IM-S-XT-N-M003-02	1/8	3	8	144	36	91	130	39	\$ 1556.00
IM-S-XT-N-M007-04	¼	7	10	180	36	91	99	30	\$ 1910.00
IM-S-XT-N-M013-08	½	13	10	180	36	91	49	15	\$ 1903.20
IM-S-XT-N-M025-16	1	25	10	180	36	91	25	7.6	\$ 1937.50

PRICING NOTE: DUE TO VOLATILITY IN RAW MATERIAL COSTS THE PRICING ON THIS PRODUCT MAY INCUR A SURCAHRGE AT TIME OF ORDERING

This Product is NOT Available By-The-Foot – Full Roll Only

Vitreous Silicate Insulation Felt / Matt / Batt

1800°F / 982°C: InSilSafe™ Extreme High Temperature Heat Flame Resistant



- Bio-soluble, organic free, vitreous silicate mineral fibre.
- An alternative to asbestos, silica and ceramic based insulation materials.
- Highly flexible and minimal shrinkage.
- Melts above 3000°F / 1648°C.
- Produced from a mineral fibre that can be used at 1800°F / 982°C continuously with excursions to 3000°F / 1650°C.

This Insulation is a needled blanket manufactured from Vitreous Silicate Fibre. This material is an excellent alternative to Refractory Ceramic Fiber (RCF), asbestos or Silica.

It is used in a variety of applications and specifically designed for use in aerospace, automotive, construction and industrial applications. Specific applications include: removable pads, furnace and oven insulation, pipe insulation, power generating equipment plus many more.

InSilSafe™ Extreme High Temperature Heat & Flame Resistant Insulation									
Part Number	Thickness		Density		Roll Width		Roll Length		Price per roll
	in	mm	lbs/ft ³	kg/m ³	in	cm	ft	m	
IM-IS-24-M007-04	¼	7	10	180	24	91	100	30	\$ 223.00
IM-IS-24-M013-08	½	13	10	180	24	91	50	15	\$ 175.67
IM-IS-24-M025-16	1	25	10	180	24	91	25	7.6	\$ 183.49
IM-IS-48-M007-04	¼	7	10	180	48	121	100	30	\$ 447.33
IM-IS-48-M013-08	½	13	10	180	48	121	50	15	\$ 351.33
IM-IS-48-M025-16	1	25	10	180	48	121	25	7.6	\$ 366.98
IM-IS-54-M007-04	¼	7	10	180	54	137	100	30	\$ 504.00
IM-IS-54-M013-08	½	13	10	180	54	137	50	15	\$ 396.00
IM-IS-54-M025-16	1	25	10	180	54	137	25	7.6	\$ 414.00
IM-IS-60-M007-04	¼	7	10	180	60	152	100	30	\$ 559.66
IM-IS-60-M013-08	½	13	10	180	60	152	50	15	\$ 439.71
IM-IS-60-M025-16	1	25	10	180	60	152	25	7.6	\$ 459.45

Ceramic Fiber Insulation: Premium Grade 2000°F / 1093°C: CerMax™ Extreme Temperature



- An alternative to asbestos based insulation materials.
- Highly flexible and minimal shrinkage.
- Melts above 3000°F / 1648°C.
- Produced from an extremely pure base fiber (SiO₂) and can be used at 2000°F / 1093°C continuously with excursions to 3000°F / 1650°C.
- This ceramic fiber insulation is a needled blanket manufactured from ceramic fiber and is an excellent alternative or replacement for asbestos.

It is used in a variety of applications and specifically designed for use in aerospace, automotive, construction and industrial applications. Specific applications include: removable pads, furnace and oven insulation, pipe insulation, power generating equipment plus many more.

CerMax Extreme High Temperature +Plus, Heat & Flame Resistant Ceramic Fiber Insulation									
Part Number	Thickness in / mm		Density lbs/ft ³ / kg/m ³		Roll Width in / cm		Roll Length ft / m		Price per roll
IM-C-6-8-24*	.50	13	6	96	24	60	25	7.6	\$ 163.33
IM-C-6-8-48	.50	13	6	96	48	121	25	7.6	\$ 163.33
IM-C-8-8-24*	.50	13	8	128	24	60	25	7.6	\$ 183.33
IM-C-8-8-48	.50	13	8	128	48	121	25	7.6	\$ 183.33
IM-C-6-16-24	1	25	6	96	24	60	25	7.6	\$ 161.67
IM-C-6-16-48	1	25	6	96	48	121	25	7.6	\$ 323.33
IM-C-8-16-24	1	25	8	128	24	60	25	7.6	\$ 180.00
IM-C-8-16-48	1	25	8	128	48	121	25	7.6	\$ 360.00
IM-C-6-32-24	2	51	6	96	24	60	12.5	3.8	\$ 160.83
IM-C-6-32-48	2	51	6	96	48	121	12.5	3.8	\$ 321.67
IM-C-8-32-24	2	51	8	128	24	60	12.5	3.8	\$ 176.67
IM-C-8-32-48	2	51	8	128	48	121	12.5	3.8	\$ 356.67
IM-C-8-16-02**	1	25	8	128	2	5	25	7.6	\$ 198.33 / box
IM-C-8-16-03***	1	25	8	128	3	7.6	25	7.6	\$ 198.33 / box

* Minimum order 2 rolls ** 12 rolls per box / *** 8 rolls per box

Thermal Conductivity: BTU•in./hr•ft²•°F (w/mK)

8 LB Density: @500°F (260°C) 0.44 (0.06); @1000°F (538°C) 0.87 (0.12); @1500°F (816°C) 1.45 (0.21)
@1800°F (982°C) 1.83 (0.26); @2000°F (1093°C) 2.09 (0.30)

6 LB Density: @500°F (260°C) 0.47 (0.07); @1000°F (538°C) 1.01 (0.15); @1500°F (816°C) 1.73 (0.25)
@1800°F (982°C) 2.19 (0.32)

Rigid Mineral Wool Insulation Board - Marine Approved

- For Decks and Bulkheads requiring up to A-60 rating
- US Coast Guard / Transport Canada / Lloyds Register Approved
- Meets latest IMO 2010 FTP Code

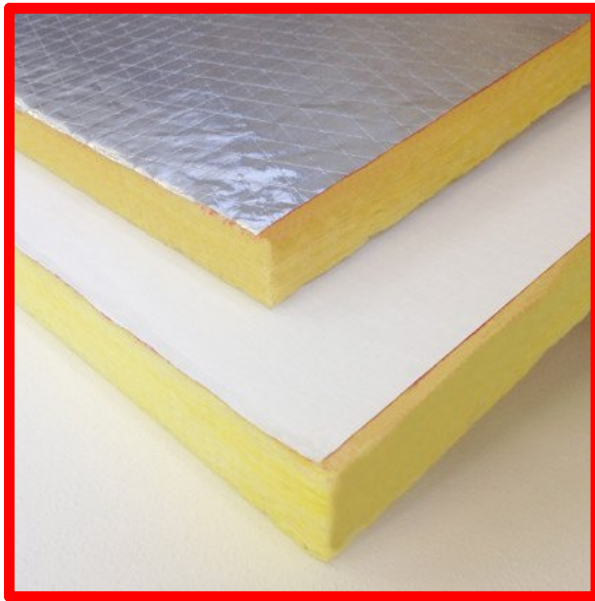

- Suitable for A-30 Steel Bulkhead, A-30 Steel Deck, A-60 Steel Bulkhead, A-60 Steel Bulkhead (restricted) and A-60 Steel Deck.
- Non combustible and fire resistant.
- Hydrophobic.
- Reinforced aluminum foil facing on one side. Also available plain (no facing) or with white fiberglass cloth one side.
- 6 lb/ ft³ density.
- Operating temperature up to 1200°F / 650°C and withstanding flame exposure to 2150°F / 1177°C without melting.

- Flame spread Index = 0, Smoke development index = 0. ASTM E84 (UL 723), CAN/ULC S102
- Thermal resistance: R-value/inch 75°F: 4.1 hr.ft²/BTU (0.72m²K/W)
- Thermal conductivity: .24 (BTU.in/hr.ft².°F) at 75°F
- Water absorption: <1% Weight
- Suitable for steel pin or wire mesh support installation. Easily cut to size.

Mineral Wool Insulation Board - Aluminum Foil Faced - Marine Approved								
Part Number	Thickness in / mm		Density	Board Width in / cm		Board Length in / cm		Price per Panel
	IM-MWR-AL--50	2"		51	6 lb/ft ²	24	60.9	

US Coast Guard Certificate of Approval: 164.107/16/0, 164.107/17/0, 164.109/26/0, 164.112/142/0

Transport Canada Certificate of Approval: LRTC 10-60002, LRTC 10-60001, LRTC 10-60004

Lloyds Register Certificate of Approval: SAS F090281, SAS F090280, SAS F090283

Abrasion Protection Sleeve & Spiral Wrap

Nylon Abrasion Resistant Braided Sleeve - .020 monofilament	6-1
Nylon Abrasion Resistant Braided Sleeve - .050 monofilament	6-2
Nylon Abrasion Resistant Braided Sleeve, woven	6-3
Nylon Abrasion Protection Sleeve A-A-59301 & MIL-C-572	6-4
Nylon Abrasion Protection Sleeve A-A-59301 & MIL-C-572: Heavy Wall	6-5
Heavy Wall Hi-Flex, .045 Wall	6-6
Heavy Wall Pro Hi-Flex, .080 Wall	6-7
Nylon, Nylon HD and Nylon/PVC Abrasion Protection Sleeve with Velcro	6-8
Nylon HD Abrasion Protection Sleeve with Velcro Hook Loop closure	6-9
Nylon HD Abrasion Protection Sleeve with Velcro Hook Loop closure – Custom Size	6-10
PET Flexible Wrappable Split Braid Sleeve	6-11
Polyester Flexible Wrappable Split Woven Sleeve	6-12
Polyester Flexible Wrappable Split Woven Sleeve with Hook One Side	6-13
Hydraulic Blowout Protection Sleeve	6-14
Hard Shell Hose and Cable Protection Spiral Wrap	6-15
HDPE Spiral Wrap Hard Shell Hose and Cable Protection	6-16
Mine Approved Hard Shell Hose and Cable Protection MSHA IC-271	6-17
Spiral Wrap with Wear Indicating Layer for Hose & Cable Protection	6-18



Nylon Abrasion
Protection Sleeve
Page 6-1



Small Size Abrasion
Protection Sleeve. Page 6-2



Abrasion Protection Sleeve
with Velcro. Page 6-3



Tuff-Wrap™ Hard Shell
Abrasion Protection
Spiral Wrap Page 6-10

Abrasion & Wear Resistant Nylon 6-6 Braided Sleeve .020" Monofilament Construction Very High Abrasion Resistance for Hose, Wire and Cable Protection



- Abrasion and wear resistant protection sleeve for hoses, wires and cables.
- Made from 20 mil (.020") monofilament Nylon 6-6 – provides a tight weave and smooth surface resists abrasive wear. Wall thickness .04"
- Expandable for ease of installation. Easily cut to length with heat knife.
- Nylon 6-6 provides excellent UV protection.
- Minimum temperature: -76°F / -60°C. Maximum continuous 302°F / 150°C (MIL-I-23053). Melting temperature 509°F / 265°C.
- 2500 abrasion cycle rated

- Tensile strength - yarn: 19 lbs (ASTM D-2265).



Scuff-Sleeve™ Braided Nylon Expandable Protection Sleeve fabricated from .020" Monofilament elements. Wall thickness .04"				
Part Number	Nominal Size	Range	Spool Size & Price	
			Bulk Spool	Shop Spool
S-NY-APS-ES20-M006-04-X	0.25"	0.25 – 0.50	500 ft / \$ 210.00	100 ft / \$ 52.00
S-NY-APS-ES20-M013-08-X	0.50"	0.50 – 1.00	250 ft / \$ 160.00	100 ft / \$ 72.00
S-NY-APS-ES20-M019-12-X	0.75"	0.75 – 1.25	250 ft / \$ 185.00	50 ft / \$ 47.00
S-NY-APS-ES20-M025-16-X	1.00"	1.00 – 1.50"	250 ft / \$ 220.00	50 ft / \$ 54.00
S-NY-APS-ES20-M032-20-X	1.25"	1.25 – 2.00	250 ft / \$ 240.00	50 ft / \$ 58.00
S-NY-APS-ES20-M044-28-X	1.75"	1.75 – 2.75	100 ft / \$ 130.00	25 ft / \$ 42.50
S-NY-APS-ES20-M057-36-X	2.25"	2.25 – 3.00	100 ft / \$ 172.00	25 ft / \$ 53.00

For the "X" value in the part number: specify "B" for Bulk Spool or "S" for Shop Spool



Abrasion & Wear Resistant Nylon 6-6 Braided Sleeve
.050 Flattened Monofilament Construction
Extremely high abrasion resistance for Hose, Wire and Cable Protection



- Abrasion and wear resistant protection sleeve for hoses, wires and cables.
- Made from flattened 50 mil (.050") monofilament nylon 6-6 – provides a tight weave and smooth surface resists abrasive wear.
- Expandable.
- Nylon 6 provides excellent UV protection.
- Easily cut to length with heat knife.
- Minimum temperature: -76°F / -60°C. Maximum continuous 302°F / 150°C (MIL-I-23053). Melting temperature 509°F / 265°C.
- 4400 abrasion cycle rated



Scuff-Sleeve™ Braided Nylon Expandable Protection Sleeve Fabricated from Flattened .050 Monofilament				
Part Number	Nominal Size	Range	Spool Size & Price	
			Bulk Spool	Shop Spool
S-NY-APS-ES50-M013-08-X	0.50"	0.375 – 0.625	500 ft / \$ 365.00	100 ft / \$ 83.00
S-NY-APS-ES50-M019-12-X	0.75"	0.625 – 1.00	250 ft / \$ 230.50	50 ft / \$ 56.10
S-NY-APS-ES50-M025-16-X	1.00"	0.975 – 1.25"	250 ft / \$ 269.00	50 ft / \$ 63.80
S-NY-APS-ES50-M032-20-X	1.25"	1.00 – 1.50	250 ft / \$ 333.50	50 ft / \$ 76.70
S-NY-APS-ES50-M044-28-X	1.75"	1.50 – 2.00	100 ft / \$ 163.00	25 ft / \$ 50.76
S-NY-APS-ES50-M057-36-X	2.00"	1.75 – 2.75	100 ft / \$ 204.60	25 ft / \$ 61.16

For the "X" value in the part number: specify "B" for Bulk Spool or "S" for Shop Spool



Nylon Abrasion & Wear Protection Sleeve

375°F / 190°C: Abrasion & Wear Resistant Scuff-Sleeve™: for Hose, Wire and Cable Protection



- Abrasion, wear, puncture and cut resistant protection sleeve for hoses, wires and cables.
- Exceeds the new “Line of Sight” operator protection regulations EN982 ISO norm 833 EN414 for hose blowout.
- Ultra tight weave provides leak containment.
- Tight weave and smooth surface resists abrasive wear.
- Less bulky than older cordura sleeves.
- Nylon 6 provides excellent UV protection.
- MSHA approved.
- Exceeds ISO 6945 abrasion standard and ISO 8031 conductivity standard.
- Easily cut to length or cut with heat knife.
- Useable -60°F to +375°F.
- Also available as a Sleeve with Velcro for easy retrofit onto wires, cables or hoses that are already in place.

Helps to organize and bundle hoses and cables, while proving heat resistance to a maximum of 375°F continuous duty, and provides excellent abrasion, scuff and wear resistance.

Scuff-Sleeve™ Nylon Abrasion Protection Sleeve				
Part Number	ID Size			Price per Foot / Metre
	inch	mm	-dash	
S-NY-APS-0.67-M017-11	0.67	17	-11	\$ 1.52 / \$ 4.98
S-NY-APS-0.79-M020-13	0.79	20	-13	\$ 1.57 / \$ 5.15
S-NY-APS-0.91-M023-15	0.91	23	-15	\$ 1.62 / \$ 5.31
S-NY-APS-0.98-M024-16	0.98	24	-16	\$ 1.79 / \$ 5.87
S-NY-APS-1.06-M026-17	1.06	26	-17	\$ 1.88 / \$ 6.17
S-NY-APS-1.22-M030-20	1.22	30	-20	\$ 1.97 / \$ 6.46
S-NY-APS-1.42-M036-23	1.42	36	-23	\$ 2.13 / \$ 6.99
S-NY-APS-1.57-M039-26	1.57	39	-26	\$ 2.28 / \$ 7.48
S-NY-APS-1.73-M043-28	1.73	43	-28	\$ 2.43 / \$ 7.97
S-NY-APS-1.85-M047-30	1.85	47	-30	\$ 2.74 / \$ 8.98
S-NY-APS-2.17-M055-35	2.17	55	-35	\$ 3.16 / \$ 10.37
S-NY-APS-2.36-M059-38	2.36	59	-38	\$ 3.43 / \$ 11.25
S-NY-APS-2.62-M066-42	2.62	66	-42	\$ 3.81 / \$ 12.49
S-NY-APS-2.87-M072-46	2.87	72	-46	\$ 4.67 / \$ 15.32
S-NY-APS-3.14-M080-48	2.95	80	-48	\$ 5.12 / \$ 16.79
S-NY-APS-3.66-M092-59	3.66	92	-59	\$ 5.80 / \$ 19.03
S-NY-APS-3.94-M100-63	3.94	100	-63	\$ 8.20 / \$ 26.89
S-NY-APS-4.41-M112-70	4.41	112	-70	\$ 9.54 / \$ 31.29
S-NY-APS-4.94-M125-80	4.94	125	-80	\$ 9.77 / \$ 32.05
S-NY-APS-5.75-M146-92	5.75	146	-92	\$ 12.62 / \$ 41.39

- Sold in standard lengths of 75, 150 and 300 feet. Other lengths may be available: please enquire. This sleeve is non-expandable – please measure your application carefully.



Nylon Abrasion & Wear Protection Sleeve – MIL Spec
375°F / 190°C: Abrasion & Wear Resistant Scuff-Sleeve™: for Hose, Wire and Cable Protection – Meets A-A-59301 & MIL-C-572 Specifications



- Abrasion, wear, puncture and cut resistant protection sleeve for hoses, wires and cables.
- Conforms to Commercial Item Description (CID) A-A-59301 and specification MIL-C-572.
- Tight weave and smooth surface resists abrasive wear.
- Nylon 6 provides excellent UV protection.
- Easily cut to length or cut with heat knife.
- Useable -60°F to +375°F.
- For heavier wall see part number S-NY-APS-MILHD.

Helps to organize and bundle hoses and cables, while proving heat resistance to a maximum of 375°F continuous duty, and provides excellent abrasion, puncture, cut, scuff and wear resistance.

Scuff-Sleeve™ Nylon Abrasion & Wear Protection Sleeve					
Meets A-A-59301 and MIL-C-572 Specifications					
Part Number	ID Size inch / mm / -dash			Wall Thickness	Spool Feet / Spool Price
S-NY-APS-MIL-M002-01	1/16	1.58	-01	.027	500 / \$ 227.87
S-NY-APS-MIL-M003-02	1/8	3.17	-02	.027	500 / \$ 326.63
S-NY-APS-MIL-M005-03	3/16	4.76	-03	.026	500 / \$ 404.25
S-NY-APS-MIL-M006-04	1/4	6.35	-04	.025	500 / \$ 611.25
S-NY-APS-MIL-M008-05	5/16	7.93	-05	.025	500 / \$ 722.13
S-NY-APS-MIL-M010-06	3/8	9.52	-06	.024	250 / \$ 399.69
S-NY-APS-MIL-M011-07	7/16	11.12	-07	.024	250 / \$ 460.25
S-NY-APS-MIL-M013-08	1/2	12.7	-08	.024	250 / \$ 505.06
S-NY-APS-MIL-M016-10	5/8	15.87	-10	.033	150 = \$ 536.70 / 250 = \$ 894.50
S-NY-APS-MIL-M019-12	3/4	19.05	-12	.037	150 = \$ 697.13 / 250 = \$ 1161.87
S-NY-APS-MIL-M022-14	7/8	22.22	-14	.036	100 = \$ 544.27 / 250 = \$ 1360.68
S-NY-APS-MIL-M025-16	1	25.4	-16	.040	100 = \$ 603.90 / 250 = \$ 1509.87
S-NY-APS-MIL-M029-18	1 1/8	28.57	-18	.040	100 = \$ 965.60 / 250 = \$ 2414.00
S-NY-APS-MIL-M032-20	1 1/4	31.75	-20	.048	100 = \$ 1054.35 / 250 = \$ 2635.87
S-NY-APS-MIL-M038-24	1 1/2	38.10	-24	.044	100 / \$ 1221.65
S-NY-APS-MIL-M045-28	1 3/4	44.45	-28	.045	100 / \$ 1311.37
S-NY-APS-MIL-M051-32	2	50.8	-32	.047	100 / \$ 1402.47

- Other lengths may be available: please enquire.
- This sleeve is non-expandable – please measure your application carefully.



**Nylon Abrasion & Wear Protection Sleeve – MIL Spec Heavy Duty
 375°F / 190°C: Abrasion & Wear Resistant Scuff-Sleeve™: for Hose, Wire and
 Cable Protection Meets A-A-59301 & MIL-C-572 Specifications**



- Heavy Wall version of S-NY-APS-MIL sleeve.
- Abrasion, wear, puncture and cut resistant protection sleeve for hoses, wires and cables.
- Conforms to A-A-59301 and MIL-C-572 specifications.
- Tight weave and smooth surface resists abrasive wear.
- Nylon 6 provides excellent UV protection.
- Easily cut to length or cut with heat knife.
- Useable -60°F to +375°F.

Helps to organize and bundle hoses and cables, while proving heat resistance to a maximum of 375°F continuous duty, and provides excellent abrasion, scuff and wear resistance.

Scuff-Sleeve™ Nylon Abrasion & Wear Protection Sleeve – Heavy Wall Meets A-A-59301 and MIL-C-572 Specifications					
Part Number	ID Size inch / mm / -dash			Wall Thickness	Spool Feet / Spool Price
S-NY-APS-MILHD-M005-03	3/16	4.76	-03	.029	500 / \$ 548.25
S-NY-APS-MILHD-M006-04	1/4	6.35	-04	.030	500 / \$ 729.37
S-NY-APS-MILHD-M008-05	5/16	7.93	-05	.030	500 / \$ 911.87
S-NY-APS-MILHD-M010-06	3/8	9.52	-06	.032	250 / \$ 533.56
S-NY-APS-MILHD-M011-07	7/16	11.12	-07	.032	250 / \$ 577.12
S-NY-APS-MILHD-M013-08	1/2	12.7	-08	.034	250 / \$ 617.94
S-NY-APS-MILHD-M016-10	5/8	15.87	-10	.038	150 = \$ 613.54 / 250 = \$ 1022.56
S-NY-APS-MILHD-M019-12	3/4	19.05	-12	.042	150 = \$ 742.46 / 250 = \$ 1237.44
S-NY-APS-MILHD-M022-14	7/8	22.22	-14	.042	100 = \$ 661.05 / 250 = \$ 1652.63
S-NY-APS-MILHD-M025-16	1	25.4	-16	.047	100 = \$ 815.85 / 250 = \$ 2039.63

- Other lengths may be available: please enquire.
- This sleeve is non-expandable – please measure your application carefully.



Nylon Abrasion & Wear Protection Sleeve – Heavy Wall
375°F / 190°C: Abrasion & Wear Resistant Scuff-Sleeve™: Heavy Wall Hi-Flex
Protection for Hose, Wire and Cable Protection



- .045" Wall Thickness .
- Excellent abrasion & wear resistant sleeve for hoses, wires and cables.
- Conforms to ISO 6945 and MSHA standards. Protection from hose rupture.
- Tight weave and smooth surface resists abrasive wear.
- Nylon 6 provides excellent UV protection.
- Easily cut to length or cut with heat knife.
- Useable -60°F to +375°F.
- High wear resistant sleeve with 3500 abrasion cycle rating

Scuff-Sleeve™ Heavy Wall Hi-Flex Nylon Abrasion & Wear Protection Sleeve – .045" Heavy Wall Thickness					
Part Number	Size inch / mm / -dash			Spool Size & Price	
				Bulk Spool	Shop Spool
S-NY-APS-HD45-0.71-M018-11-X	0.71	18	-11	100 ft / \$ 112.00	50 ft / \$ 66.00
S-NY-APS-HD45-0.83-M021-13-X	0.83	21	-13	100 ft / \$ 117.80	50 ft / \$ 68.90
S-NY-APS-HD45-0.92-M023-15-X	0.92	23	-15	100 ft / \$ 118.80	50 ft / \$ 69.40
S-NY-APS-HD45-1.00-M025-16-X	1.00	25	-16	100 ft / \$ 119.40	50 ft / \$ 69.70
S-NY-APS-HD45-1.13-M029-18-X	1.13	29	-18	100 ft / \$ 128.40	50 ft / \$ 74.20
S-NY-APS-HD45-1.25-M032-20-X	1.25	32	-20	100 ft / \$ 143.20	50 ft / \$ 81.60
S-NY-APS-HD45-1.34-M034-22-X	1.34	34	-22	100 ft / \$ 159.20	50 ft / \$ 89.60
S-NY-APS-HD45-1.59-M040-25-X	1.59	40	-25	100 ft / \$ 167.20	50 ft / \$ 93.60
S-NY-APS-HD45-1.75-M044-28-X	1.75	44	-28	100 ft / \$ 172.00	50 ft / \$ 96.00
S-NY-APS-HD45-2.07-M053-33-X	2.07	53	-33	100 ft / \$ 205.00	50 ft / \$ 112.50
S-NY-APS-HD45-2.38-M060-38-X	2.38	60	-38	100 ft / \$ 256.00	50 ft / \$ 138.00
S-NY-APS-HD45-2.54-M065-41-X	2.54	65	-41	100 ft / \$ 294.00	50 ft / \$ 157.00
S-NY-APS-HD45-2.86-M073-46-X	2.86	73	-46	100 ft / \$ 332.60	50 ft / \$ 176.30
S-NY-APS-HD45-3.34-M085-53-X	3.34	85	-53	50 ft / \$ 186.60	25 ft / \$ 103.16
S-NY-APS-HD45-3.66-M093-59-X	3.66	93	-59	50 ft / \$ 195.80	25 ft / \$ 107.70

For the "X" value in the part number: specify "B" for Bulk Spool or "S" for Shop Spool

This sleeve is non-expandable – please measure your application carefully.

Helps to organize and bundle hoses and cables, while proving heat resistance to a maximum of 375°F continuous duty, and provides excellent abrasion, scuff and wear resistance.



Nylon Abrasion & Wear Protection Sleeve – Pro Heavy Duty
375°F / 190°C: Abrasion & Wear Resistant Scuff-Sleeve™: PRO Heavy Wall Hi-Flex Protection for Hose, Wire and Cable



- .080" Wall Thickness.
- Excellent abrasion & wear resistant sleeve for hoses, wires and cables.
- Conforms to ISO 6945 and MSHA standards. Protection from hose rupture.
- Tight weave and smooth surface resists abrasive wear. Smooth inner wall surface.
- Nylon 6 provides excellent UV protection.
- Easily cut to length or cut with heat knife.
- Useable -60°F to +375°F.
- Our highest wear resistant sleeve with 13,000 abrasion cycle rating.

Helps to organize and bundle hoses and cables, while proving heat resistance to a maximum of 375°F continuous duty, and provides excellent abrasion, scuff and wear resistance.

Scuff-Sleeve™ PRO Heavy Wall Hi-Flex Nylon Abrasion & Wear Protection Sleeve – .080" Heavy Wall Thickness					
Part Number	Size inch / mm / -dash			Spool Size & Price	
				Bulk Spool	Shop Spool
S-NY-APS-HD80-0.75-M019-12-X	0.75	19	-12	100 ft / \$ 177.40	50 ft / \$ 98.70
S-NY-APS-HD80-0.93-M024-15-X	0.93	24	-15	100 ft / \$ 207.20	50 ft / \$ 113.60
S-NY-APS-HD80-1.13-M029-18-X	1.13	29	-18	100 ft / \$ 250.80	50 ft / \$ 135.40
S-NY-APS-HD80-1.25-M032-20-X	1.25	32	-20	100 ft / \$ 283.00	50 ft / \$ 151.50
S-NY-APS-HD80-1.35-M034-22-X	1.35	34	-22	100 ft / \$ 288.80	50 ft / \$ 154.40
S-NY-APS-HD80-1.43-M036-23-X	1.43	36	-23	100 ft / \$ 315.00	50 ft / \$ 167.50
S-NY-APS-HD80-1.63-M041-26-X	1.63	41	-26	100 ft / \$ 345.00	50 ft / \$ 182.50
S-NY-APS-HD80-1.81-M046-29-X	1.81	46	-29	100 ft / \$ 408.60	50 ft / \$ 214.30
S-NY-APS-HD80-2.19-M056-35-X	2.19	56	-35	100 ft / \$ 467.60	50 ft / \$ 243.80
S-NY-APS-HD80-2.63-M067-42-X	2.63	67	-42	100 ft / \$ 612.60	50 ft / \$ 316.30
S-NY-APS-HD80-2.88-M073-46-X	2.88	73	-46	100 ft / \$ 685.80	50 ft / \$ 352.90
S-NY-APS-HD80-3.13-M080-50-X	3.13	80	-50	50 ft / \$ 367.40	25 ft / \$ 193.60
S-NY-APS-HD80-3.38-M086-54-X	3.38	86	-54	50 ft / \$ 399.20	25 ft / \$ 209.56
S-NY-APS-HD80-3.63-M092-58-X	3.63	92	-58	50 ft / \$ 426.20	25 ft / \$ 223.06
S-NY-APS-HD80-4.00-M102-64-X	4.00	102	-64	50 ft / \$ 471.80	25 ft / \$ 245.70

For the "X" value in the part number:
 specify "B" for Bulk Spool or "S" for Shop Spool

This sleeve is non-expandable – please measure your application carefully.



Abrasion & Wear Protection Sleeve with Velcro® Hook & Loop Closure for Wires, Cables and Hoses: 1050 Denier Ballistic Nylon -60°F / -51°C to 275°F / 135°C Temperature Range



- Abrasion resistance for hoses, wire and cables.
- Sleeve with Velcro hook and loop for easy retrofit.
- Several fabric types available for particular applications.
- Not recommended for welding environments.
- Used on mobile equipment and CE approved equipment for operator protection from hose failure.

This sleeve is made from 1050 denier ballistic nylon which has a 1.7mil urethane coating for repelling surface moisture. 13.5oz/yd² material weight. Temperature range -60°C to +275°F. Very good UV protection. This is our most popular abrasion protection sleeve.

Helps to organize and bundle hoses and cables; excellent abrasion, scuff and wear resistance.

Scuff-Sleeve™ VCL: 1050 Ballistic Nylon Abrasion & Wear Protection Sleeve with Velcro Closure for wire, cable and hose						
Part Number	ID Size inch / mm / -dash			Price		
				150 foot roll	50 foot roll	Per Foot
*S-NY1050-VCL-1.000-M025-16-X	1.00	25	-16	\$ 745.20	\$ 262.20	\$ 5.52
*S-NY1050-VCL-1.300-M033-21-X	1.30	33	-21	\$ 847.80	\$ 298.30	\$ 6.28
*S-NY1050-VCL-1.500-M038-24-X	1.50	38	-24	\$ 899.10	\$ 316.35	\$ 6.67
S-NY1050-VCL-1.750-M044-28-X	1.75	44	-28	\$ 1123.20	\$ 395.20	\$ 8.32
S-NY1050-VCL-2.000-M051-32-X	2.00	51	-32	\$ 1150.20	\$ 404.70	\$ 8.52
S-NY1050-VCL-2.380-M060-38-X	2.38	60	-38	\$ 1225.80	\$ 431.30	\$ 9.08
S-NY1050-VCL-2.500-M064-40-X	2.50	64	-40	\$ 1285.20	\$ 452.20	\$ 9.52
S-NY1050-VCL-2.750-M070-44-X	2.75	70	-44	\$ 1417.50	\$ 498.75	\$ 10.50
S-NY1050-VCL-3.000-M076-48-X	3.00	76	-48	\$ 1428.30	\$ 502.55	\$ 10.58
S-NY1050-VCL-3.250-M083-52-X	3.25	83	-52	\$ 1433.70	\$ 504.45	\$ 10.62
S-NY1050-VCL-3.500-M089-56-X	3.50	89	-56	\$ 1441.80	\$ 507.30	\$ 10.68
S-NY1050-VCL-4.000-M102-64-X	4.00	102	-64	\$ 1717.20	\$ 604.20	\$ 12.72
S-NY1050-VCL-4.500-M114-72-X	4.50	114	-72	\$ 1725.30	\$ 607.05	\$ 12.78
S-NY1050-VCL-5.000-M127-80-X	5.00	127	-80	\$ 1736.10	\$ 610.85	\$ 12.86
S-NY1050-VCL-6.000-M152-96-X	6.00	152	-96	\$ 2316.60	\$ 815.10	\$ 17.16
S-NY1050-VCL-7.000-M178-112-X	7.00	165	-104	\$ 2408.40	\$ 847.40	\$ 17.84
S-NY1050-VCL-8.000-M203-128-X	8.00	203	-128	\$ 2592.00	\$ 912.00	\$ 19.20
S-NY1050-VCL-9.000-M228-144-X	9.00	228	-144	\$ 2778.30	\$ 977.55	\$ 20.58
S-NY1050-VCL-10.000-M241-152-X	10.00	254	-160	\$ 3534.30	\$ 1243.55	\$ 26.18
S-NY1050-VCL-11.000-M241-152-X	11.00	279	-176	\$ 3688.20	\$ 1297.70	\$ 27.32
S-NY1050-VCL-12.000-M305-192-X	12.00	305	-192	\$ 3920.40	\$ 1379.40	\$ 29.04

For the "X" value in the part number:
 "FOOT" for By-The-Foot, "150ROLL" for 150 foot roll "50ROLL" for 50 foot roll
 Width of the Velcro is 1.5" except part numbers indicated with (*) which is .75".
 THIS PRODUCT IS AVAILABLE IN ANY ID SIZE – PLEASE ASK FOR A QUOTE

Enhanced Abrasion & Wear Protection Sleeve with Velcro® Hook & Loop Closure for Wires, Cables and Hoses: HD Nylon

-60°F / -51°C to 275°F / 135°C Temperature Range



- Enhanced abrasion resistance for hoses, wire and cables.
- Sleeve with Velcro hook and loop for easy retrofit.
- Not recommended for welding environments.
- Heavy urethane coating provides low coefficient of friction.
- Meets MIL-C-83489, FED-STD-191A, MIL-STD-810F

This sleeve is made from 1000 denier nylon which has a 5mil urethane coating for repelling surface moisture. 13.5oz/yd² material weight. Temperature range -60°C to +275°F. Very good UV protection.

Helps to organize and bundle hoses and cables; excellent abrasion, scuff and wear resistance.

Scuff-Sleeve™ VCL: HD Nylon / Enhanced Abrasion & Wear Protection Sleeve with Velcro Closure for wire, cable and hose						
Part Number	ID Size inch / mm / -dash			Price		
				150 foot roll	50 foot roll	Per Foot
*S-NY5601-VCL-1.000-M025-16-X	1.00	25	-16	\$ 918.00	\$ 323.00	\$ 6.80
*S-NY5601-VCL-1.300-M033-21-X	1.30	33	-21	\$ 1043.55	\$ 367.17	\$ 7.73
*S-NY5601-VCL-1.500-M038-24-X	1.50	38	-24	\$ 1107.00	\$ 389.50	\$ 8.20
S-NY5601-VCL-1.750-M044-28-X	1.75	44	-28	\$ 1386.45	\$ 487.83	\$ 10.27
S-NY5601-VCL-2.000-M051-32-X	2.00	51	-32	\$ 1421.55	\$ 500.18	\$ 10.53
S-NY5601-VCL-2.380-M060-38-X	2.38	60	-38	\$ 1507.95	\$ 530.58	\$ 11.17
S-NY5601-VCL-2.500-M064-40-X	2.50	64	-40	\$ 1583.55	\$ 557.18	\$ 11.73
S-NY5601-VCL-2.750-M070-44-X	2.75	70	-44	\$ 1750.95	\$ 616.08	\$ 12.97
S-NY5601-VCL-3.000-M076-48-X	3.00	76	-48	\$ 1764.45	\$ 620.83	\$ 13.07
S-NY5601-VCL-3.250-M083-52-X	3.25	83	-52	\$ 1768.50	\$ 622.25	\$ 13.10
S-NY5601-VCL-3.500-M089-56-X	3.50	89	-56	\$ 1777.95	\$ 625.58	\$ 13.17
S-NY5601-VCL-4.000-M102-64-X	4.00	102	-64	\$ 2115.45	\$ 744.33	\$ 15.67
S-NY5601-VCL-4.500-M114-72-X	4.50	114	-72	\$ 2123.55	\$ 747.18	\$ 15.73
S-NY5601-VCL-5.000-M127-80-X	5.00	127	-80	\$ 2137.05	\$ 751.93	\$ 15.83
S-NY5601-VCL-6.000-M152-96-X	6.00	152	-96	\$ 2857.95	\$ 1005.58	\$ 21.17
S-NY5601-VCL-7.000-M178-112-X	7.00	165	-104	\$ 2965.95	\$ 1043.58	\$ 21.97
S-NY5601-VCL-8.000-M203-128-X	8.00	203	-128	\$ 3190.05	\$ 1122.43	\$ 23.63

For the "X" value in the part number:

"FOOT" for By-The-Foot, "150ROLL" for 150 foot roll "50ROLL" for 50 foot roll

Width of the Velcro is 1.5" except part numbers indicated with (*) which is .75".

THIS PRODUCT IS AVAILABLE IN ANY ID SIZE – PLEASE ASK FOR A QUOTE

Extreme Abrasion & Wear Protection Sleeve with Velcro® Hook & Loop Closure for Wires, Cables and Hoses: XHD Nylon

-60°F / -51°C to 275°F / 135°C Temperature Range



- Enhanced abrasion resistance for hoses, wire and cables.
- Sleeve with Velcro hook and loop for easy retrofit.
- Not recommended for welding environments.
- Heavy urethane coating provides low coefficient of friction.
- Meets UV protection standard EN13758-1, Top Rating of 80
- MSHA - IC289 approved
- Meets ISO 6945 specifications - 500,000+ abrasion cycles.

This sleeve is made from 1500 denier nylon which has a polymer coating for advanced abrasion protection and the ability to repel surface moisture. 40oz/yd² material weight. Temperature range -60°C to +275°F. Very good UV protection.

Helps to organize and bundle hoses and cables; excellent abrasion, scuff and wear resistance.

Scuff-Sleeve™ VCL: XHD Nylon / Enhanced Abrasion & Wear Protection Sleeve with Velcro Closure for wire, cable and hose						
Part Number	ID Size			Price		
	inch	mm	-dash	150 foot roll	50 foot roll	Per Foot
S-NY40HDA-VCL-1.750-M044-28-X	1.75	44	-28	\$ 2231.55	\$ 785.18	\$ 16.53
S-NY40HDA-VCL-2.000-M051-32-X	2.00	51	-32	\$ 2245.05	\$ 789.93	\$ 16.63
S-NY40HDA-VCL-2.380-M060-38-X	2.38	60	-38	\$ 2277.45	\$ 801.33	\$ 16.87
S-NY40HDA-VCL-2.500-M064-40-X	2.50	64	-40	\$ 2484.00	\$ 874.00	\$ 18.40
S-NY40HDA-VCL-2.750-M070-44-X	2.75	70	-44	\$ 2547.45	\$ 896.33	\$ 18.87
S-NY40HDA-VCL-3.000-M076-48-X	3.00	76	-48	\$ 2641.95	\$ 929.58	\$ 19.57
S-NY40HDA-VCL-3.250-M083-52-X	3.25	83	-52	\$ 2736.45	\$ 962.83	\$ 20.27
S-NY40HDA-VCL-3.500-M089-56-X	3.50	89	-56	\$ 2817.45	\$ 991.33	\$ 20.87
S-NY40HDA-VCL-4.000-M102-64-X	4.00	102	-64	\$ 3284.55	\$ 1155.68	\$ 24.33
S-NY40HDA-VCL-4.500-M114-72-X	4.50	114	-72	\$ 3298.05	\$ 1160.43	\$ 24.43
S-NY40HDA-VCL-5.000-M127-80-X	5.00	127	-80	\$ 3330.45	\$ 1171.83	\$ 24.67
S-NY40HDA-VCL-6.000-M152-96-X	6.00	152	-96	\$ 4445.55	\$ 1564.18	\$ 32.93
S-NY40HDA-VCL-7.000-M178-112-X	7.00	165	-104	\$ 4504.95	\$ 1585.08	\$ 33.37
S-NY40HDA-VCL-8.000-M203-128-X	8.00	203	-128	\$ 4567.05	\$ 1606.93	\$ 33.83
S-NY40HDA-VCL-9.000-M228-144-X	9.00	228	-144	\$ 4756.05	\$ 1673.43	\$ 35.23
S-NY40HDA-VCL-10.000-M241-152-X	10.00	254	-160	\$ 5773.95	\$ 2031.58	\$ 42.77
S-NY40HDA-VCL-11.000-M241-152-X	11.00	279	-176	\$ 6061.50	\$ 2132.75	\$ 44.90
S-NY40HDA-VCL-12.000-M305-192-X	12.00	305	-192	\$ 6875.55	\$ 2419.18	\$ 50.93

For the "X" value in the part number:

"FOOT" for By-The-Foot, "150ROLL" for 150 foot roll "50ROLL" for 50 foot roll

Width of the Velcro is 1.5" except part numbers indicated with (*) which is .75".

THIS PRODUCT IS AVAILABLE IN ANY ID SIZE – PLEASE ASK FOR A QUOTE

Nylon with PVC Coating Abrasion Protection Sleeve with Velcro Hook & Loop Closure

375°F / 190°C: Abrasion and Wear Resistance for Wire, Cable and Hose Protection



- Abrasion resistance for hoses, wire and cables.
- Sleeve with Velcro hook and loop for easy retrofit.
- Several fabric types for particular applications.

PVC/Nylon sleeve is a heavy flexible PVC over a 1000 denier base fabric. Tough protection for cables and hoses used on the ground, for construction equipment, drill rigs, etc. Temperature range -13°F / -25°C to +158°F / 70°C. Very good UV protection.

Sold in 25 foot increments up to 150 feet continuous rolls. Available in standard sizes; larger or custom sizes can be easily fabricated if required. Helps to organize and bundle hoses and cables, excellent abrasion, scuff and wear resistance.

Scuff-Sleeve™ VCL: Nylon with PVC Coating Abrasion Protection Sleeve with Hook and Loop Closure				
Part Number	Size inch / mm / -dash			Price per Foot
*S-NY-PVC-APS-VCL-M025-16	1.00	25	-16	\$ 10.20
*S-NY-PVC-APS-VCL-M038-24	1.50	38	-24	N/A
S-NY-PVC-APS-VCL-M044-28	1.75	44	-28	N/A
S-NY-PVC-APS-VCL-M051-32	2.00	51	-32	\$ 11.36
S-NY-PVC-APS-VCL-M060-38	2.38	60	-38	\$ 12.28
S-NY-PVC-APS-VCL-M064-40	2.50	64	-40	\$ 13.08
S-NY-PVC-APS-VCL-M070-44	2.75	70	-44	N/A
S-NY-PVC-APS-VCL-M076-48	3.00	76	-48	\$ 13.52
S-NY-PVC-APS-VCL-M083-52	3.25	83	-52	\$ 14.72
S-NY-PVC-APS-VCL-M089-56	3.50	89	-56	\$ 15.84
S-NY-PVC-APS-VCL-M102-64	4.00	102	-64	\$ 13.96
S-NY-PVC-APS-VCL-M114-72	4.50	114	-72	\$ 16.76
S-NY-PVC-APS-VCL-M127-80	5.00	127	-80	\$ 17.06
S-NY-PVC-APS-VCL-M152-96	6.00	152	-96	\$ 17.20
S-NY-PVC-APS-VCL-M178-112	7.00	165	-104	\$ 20.88
S-NY-PVC-APS-VCL-M203-128	8.00	203	-128	\$ 21.43
#S-NY-PVC-APS-VCL-M241-152	9.50	241	-152	N/A
S-NY-PVC-APS-VCL-M305-192	12.00	305	-192	\$ 36.63

Minimum Order Quantity may be in effect for smaller diameters

Width of the Velcro is 1.5" except part numbers indicated with (*) which is .75".

#: sleeve length is 12 foot sections.

Abrasion Protection & General Organizing Sleeve – custom sized
375°F / 190°C: Scuff-Sleeve™ VC, with Velcro: for Wire, Cable and Hose
Custom Sized



- Abrasion resistance for hoses, wire and cables.
- Sleeve with Velcro for easy retrofit.
- HD Nylon.

HD Nylon sleeve is made from 1050 denier nylon (very heavy duty “ballistic” nylon) which has a 1.5oz urethane coating. Temperature range - 60°C to +375°F. Very Good UV protection.

This sleeve is fabricated from slit fabric that has Velcro closure added along each long side, resulting in a sleeve that is custom fit for your application.

Minimum order is \$50 per size. Maximum length is 150 feet.

The ID of this sleeve is a minimum of 1 inch and the maximum is almost limitless.

Helps to organize and bundle hoses and cables, excellent abrasion, scuff and wear resistance.

Scuff-Sleeve™ Custom VCL: Abrasion Protection Sleeve with Velcro	
Part Number	Price per Foot
S-NY-APSC-VCL-MXXX-Y-Z	\$ 4.31 per inch of ID x sleeve length in feet + \$ 3.61 x sleeve length in feet

For the “X” value in the part number: specify the inside diameter in millimetres.

For the “Y” value in the part number: specify the inside diameter in 1/16 of an inch increments.

For the “Z” value in the part number: specify the length of the sleeve in feet.

Pricing Example: For a 5.5” ID sleeve that is 12 feet long.

$$(\$ 4.31 \times 5.5 \times 12) + (3.61 \times 12) = \$ 284.46 + \$ 43.32$$

Total sleeve cost is \$ 327.78

SPF Spray Foam Hose Protector Sleeve with Velcro Closure

Ballistic Nylon Abrasion & Wear Protection Sleeve with Velcro® Hook & Loop Closure - Plain or with ThermGuard® Freeze Protection Liner



- Abrasion resistance and wear protection for SPF Spray Foam Hoses. FAST installation
- Sleeve with Velcro hook and loop for easy retrofit.
- Plain or with thermal liner for winter freeze protection.

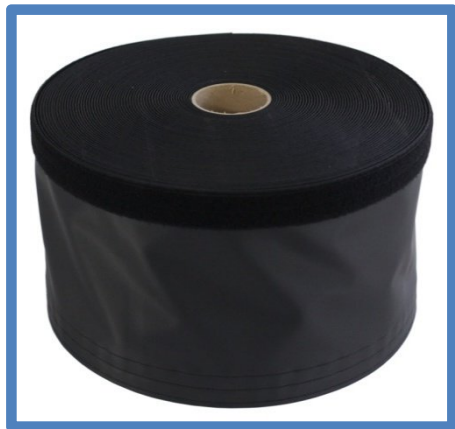

SPF Spray Foam Hose Wrap

Part Number: S-NY-SPF-SW-2173 Ballistic Nylon with heavy urethane coating.
50 foot length - 7.4 inch circumference to easily cover hoses.
\$291.60

Part Number: S-NY-SPF-SW-2175 Ballistic Nylon with heavy urethane coating and ThermGuard insulation layer
50 foot length - 8.6" circumference. Nominal thermal retention of 25°F over non insulated sleeve.
\$490.63

Part Number: S-NY-SPF-SW-2174 Coupler Guard
\$33.48

Part Number: S-NY-SPF-SW-2176 Coupler Guard with ThermGuard insulation layer
\$60.00

PET Flexible Wrappable Split Braid Sleeve

257°F / 125°C: Maximum Continuous – Melts at 482°F / 250°C



- .024" and .038" Wall Thickness .
- Good organization for in-place wires and cables.
- Medium duty abrasion resistance.
- Available in four colors: Black, Orange, Gray, Clear-White.
- Easily cut to length or cut with heat knife.
- Provides a 25% edge overlap at nominal diameter.

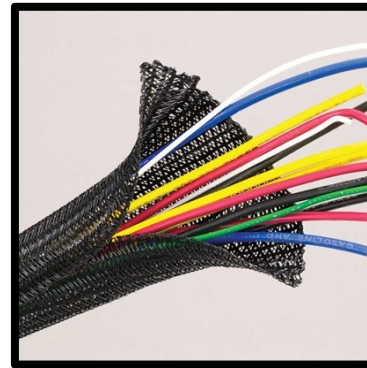

Scuff-Sleeve™ PET Flexible Wrappable Split Braid Sleeve Medium Protection Sleeve						
Part Number	ID Size inch / mm / -dash			Spool Size & Price		
				Bulk Spool	SA Shop Spool	SB Shop Spool
S-PETSPLIT-APS-0.125-M003-02-X	0.125	3	-02	8000 ft / \$ 1732.00	400 ft / \$ 90.00	100 ft / \$ 33.00
S-PETSPLIT-APS-0.250-M006-04-X	0.250	6	-04	3000 ft / \$ 1214.80	200 ft / \$ 84.90	100 ft / \$ 52.00
S-PETSPLIT-APS-0.375-M009-06-X	0.375	9.5	-06	1500 ft / \$ 872.80	150 ft / \$ 90.40	75 ft / \$ 56.60
S-PETSPLIT-APS-0.500-M013-08-X	0.500	12.7	-08	1200 ft / \$ 746.40	150 ft / \$ 98.70	75 ft / \$ 60.60
S-PETSPLIT-APS-0.750-M019-12-X	0.750	19.0	-12	500 ft / \$ 396.40	100 ft / \$ 82.20	50 ft / \$ 52.00
Above sleeve .024" wall thickness – below sleeve .038" wall thickness						
S-PETSPLIT-APS-1.000-M025-16-X	1.000	25.4	-16	400 ft / \$ 440.20	100 ft / \$ 116.60	50 ft / \$ 68.00
S-PETSPLIT-APS-1.250-M032-20-X	1.250	31.7	-20	250 ft / \$ 450.20	75 ft / \$ 140.60	25 ft / \$ 56.00
S-PETSPLIT-APS-1.500-M038-24-X	1.500	38.1	-24	250 ft / \$ 540.20	75 ft / \$ 170.60	25 ft / \$ 68.00
S-PETSPLIT-APS-2.000-M051-32-X	2.000	50.8	-32	200 ft / \$ 597.00	50 ft / \$ 160.00	25 ft / \$ 89.00

For the "X" value in the part number:
 specify "B" for Bulk Spool or "SA" for Large Shop Spool or "SB" for Small Shop Spool

Specify Color when ordering – Add 20% for colors other than black
 (except 1/8 size is 10000 foot box add 30%)

Helps to organize and bundle hoses and cables, while proving abrasion, scuff and wear resistance.

Polyester Flexible Wrappable Split Woven Sleeve

257°F / 125°C: Maximum Continuous – Melts at 482°F / 250°C



- .027" Wall Thickness .
- Good organization for in-place wires and cables.
- High abrasion resistance.
- Available in Black & White.
- Easily cut to length or cut with heat knife.

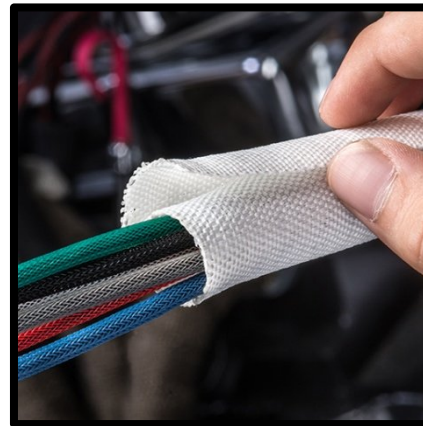

Scuff-Sleeve™ POLYWRAP Flexible Wrappable Split Woven Sleeve High Abrasion Protection Sleeve						
Part Number	ID Size inch / mm / -dash			Spool Size & Price		
				Bulk Spool	SA Shop Spool	SB Shop Spool
S-POLYSPLIT-APS-0.125-M003-02-X	0.125	3	-02	1800 ft / \$ 954.00	900 ft / \$ 476.00	300 ft / \$ 172.00
S-POLYSPLIT-APS-0.187-M005-03-X	0.187	4.7	-03	1200 ft / \$ 660.00	600 ft / \$ 330.00	200 ft / \$ 126.00
S-POLYSPLIT-APS-0.250-M006-04-X	0.250	6	-04	925 ft / \$ 530.80	460 ft / \$ 264.90	200 ft / \$ 129.00
S-POLYSPLIT-APS-0.312-M008-05-X	0.312	7.9	-05	650 ft / \$ 370.80	325 ft / \$ 185.40	125 ft / \$ 84.60
S-POLYSPLIT-APS-0.375-M009-06-X	0.375	9.5	-06	450 ft / \$ 284.80	225 ft / \$ 144.40	100 ft / \$ 81.60
S-POLYSPLIT-APS-0.500-M013-08-X	0.500	12.7	-08	300 ft / \$ 201.40	150 ft / \$ 102.70	75 ft / \$ 64.60
S-POLYSPLIT-APS-0.625-M016-10-X	0.625	15.8	-10	250 ft / \$ 193.40	125 ft / \$ 99.20	75 ft / \$ 69.00
S-POLYSPLIT-APS-0.750-M019-12-X	0.750	19.0	-12	150 ft / \$ 128.40	100 ft / \$ 86.20	50 ft / \$ 55.00
S-POLYSPLIT-APS-1.000-M025-16-X	1.000	25.4	-16	100 ft / \$ 107.20	75 ft / \$ 82.60	50 ft / \$ 64.00
S-POLYSPLIT-APS-1.500-M038-24-X	1.500	38.1	-24	50 ft / \$ 100.20	25 ft / \$ 51.60	N/A
S-POLYSPLIT-APS-1.750-M044-28-X	1.750	44.4	-28	50 ft / \$ 146.20	10 ft / \$ 42.60	N/A
S-POLYSPLIT-APS-2.000-M051-32-X	2.000	50.8	-32	40 ft / \$ 142.00	10 ft / \$ 48.00	N/A

For the "X" value in the part number:
 specify "B" for Bulk Spool or "SA" for Large Shop Spool or "SB" for Small Shop Spool

Specify Color when ordering – Add 20% for white

Helps to organize and bundle hoses and cables, while proving abrasion, scuff and wear resistance.

Polyester Flexible Wrappable Split Woven Sleeve with Hook One Side
257°F / 125°C: Maximum Continuous – Melts at 482°F / 250°C



- .025" Wall Thickness .
- Good organization for in-place wires and cables. One side hook helps keep sleeve closed without extra wrapping with clamps or tape.
- High abrasion resistance.
- Available in Black only.
- Easily cut to length or cut with heat knife.

Scuff-Sleeve™ POLYWRAP Hook Flexible Wrappable Split Woven Sleeve High Abrasion Protection Sleeve – with Hook One Side – Extra Hold					
Part Number	ID Size inch / mm / -dash			Spool Size & Price	
				Bulk Spool	Shop Spool
S-POLYSPLITHCL-APS-0.750-M019-12-X	0.750	19.0	-12	50 ft / \$ 82.40	25 ft / \$ 53.20
S-POLYSPLITHCL-APS-1.000-M025-16-X	1.000	25.4	-16	50 ft / \$ 97.20	25 ft / \$ 64.60
S-POLYSPLITHCL-APS-1.375-M035-26-X	1.375	34.9	-26	50 ft / \$ 109.20	25 ft / \$ 69.60

For the "X" value in the part number:
 specify "B" for Bulk Spool or "S" for Shop Spool

Helps to organize and bundle hoses and cables, while proving abrasion, scuff and wear resistance.

Braided PET 150% Expandable Sleeve 257°F / 125°C: Maximum Continuous – Melts at 482°F / 250°C



- .010" monofilament thickness.
- Organization with abrasion resistance.
- Available in 27 colors / patterns
- Easily cut to length or cut with heat knife.
- Expandable by 150% to pass over connectors.
- FMVSS 302 & FAR 25 approved



Scuff-Sleeve™ PET Flexible 150% Expandable Braid Sleeve						
Part Number	Range	Nominal ID Size fraction / inch / mm			Spool Size & Price	
					Bulk Spool	Shop Spool
S-PET-BRAID-EXP-0.062-M0016-XX-YY	3/64 – 3/32	1/16	0.062	1.6	1000 ft / \$ 110.00	250 ft / \$ 46.00
S-PET-BRAID-EXP-0.125-M0032-XX-YY	3/32 – 1/4	1/8	0.125	3.2	1000 ft / \$ 120.00	225 ft / \$ 46.00
S-PET-BRAID-EXP-0.250-M0063-XX-YY	1/8 – 7/16	1/4	0.250	6.3	1000 ft / \$ 127.50	200 ft / \$ 46.00
S-PET-BRAID-EXP-0.375-M0095-XX-YY	3/16 – 1/2	3/8	0.375	9.5	500 ft / \$ 110.00	125 ft / \$ 46.00
S-PET-BRAID-EXP-0.500-M0127-XX-YY	¼ - 3/4	1/2	0.500	12.7	500 ft / \$ 150.00	100 ft / \$ 46.00
S-PET-BRAID-EXP-0.625-M0158-XX-YY	3/8 - 1	5/8	0.625	15.8	500 ft / \$ 190.00	100 ft / \$ 46.00
S-PET-BRAID-EXP-0.750-M0190-XX-YY	½ - 1 1/4	3/4	0.750	19.0	250 ft / \$ 110.00	75 ft / \$ 46.00
S-PET-BRAID-EXP-1.000-M0254-XX-YY	5/8 – 1 5/8	1	1.000	25.4	250 ft / \$ 125.00	65 ft / \$ 46.00
S-PET-BRAID-EXP-1.250-M0317-XX-YY	¾ - 1 3/4	1-1/4	1.250	31.7	250 ft / \$ 150.00	50 ft / \$ 46.00
S-PET-BRAID-EXP-1.500-M0381-XX-YY	1 – 2 1/8	1-1/2	1.500	38.1	200 ft / \$ 152.00	40 ft / \$ 46.00
S-PET-BRAID-EXP-1.750-M0445-XX-YY	1 ¼ - 2 3/4	1-3/4	1.750	44.5	200 ft / \$ 200.00	30 ft / \$ 46.00
S-PET-BRAID-EXP-2.000-M0508-XX-YY	1 ½ - 3 1/2	2	2.000	50.8	200 ft / \$ 280.00	50 ft / \$ 80.00
S-PET-BRAID-EXP-2.500-M0635-XX-YY	1 ¾ - 3 5/8	2-1/2	2.500	63.5	200 ft / \$ 360.00	50 ft / \$ 100.00
S-PET-BRAID-EXP-3.000-M0762-XX-YY	2 ½ - 4 3/4	3	3.000	76.2	100 ft / \$ 200.00	50 ft / \$ 110.00

Specify Color/Pattern when ordering – Add 15% for colors other than black
 (1/16 size is only available in Black)

For the “XX” value in the part number: specify **WH** - White; **NP** – Neon Pink; **NR** – Neon Red; **NY** – Neon Yellow; **NG** – Neon Green; **NB** – Neon Blue; **PP** – Purple; **BE** – Beige; **GY** – Gray; **OG** – Orange; **JS** – Jester; **NX** – Nitrox; **CL** – Clear; **RD** – Red; **OR** – Orange; **YL** – Yellow; **GN** – Green; **BL** – Blue; **DP** – Dark Purple; **BR** – Brown; **CB** – Carbon; **SH** – Super Hero; **SS**- Safety Stripe; **PT** – Patriot; **PG** – Platinum Gray; **CF** – Checkered Flag

For the “YY” value in the part number: specify “BS” for Bulk Spool or “SS” for Shop Spool

Helps to organize and bundle hoses and cables, while proving abrasion, scuff and wear resistance.



Hydraulic Blowout Protection Sleeve - SuperGuard™

375°F / 190°C Maximum Continuous
 Protects Personnel from Hydraulic Hose & Line Blowout



- SuperGuard™ Dual layer Nylon – Nylon/Polyester construction provides protection from blowout to 13,000 PSI.
- Abrasion, wear, puncture and cut resistant protection sleeve for hydraulic hoses and lines.
- Exceeds the new “Line of Sight” operator protection regulations EN982 ISO norm 833 EN414 for hose blowout.
- Ultra dense construction is 3 times the density of our most heavy duty abrasion protection sleeve.
- Tight weave and smooth surface resists abrasive wear.
- Excellent UV resistance.
- MSHA IC 171/2 approved.
- Exceeds ISO 6945 abrasion standard and ISO 8031 conductivity standard.
- Easily cut to length or cut with heat knife.
- Useable -60°F to +375°F.
- If the inner yellow layer shows, then the sleeve must be replaced due to wear.
- NOTE: This sleeve should NOT fit tightly on the hose it is protecting, but have a clearance of ½” to 1”.
- Tested by the Fluid Power Institute.
- Also meets ISO 3457, ISO 4413, MDG41

SuperGuard™ Hydraulic Blowout Protection Sleeve				
Part Number	Nominal ID Size			Price per Coil
	inch	mm	-dash	
S-NY-BPS-M026-17	1.21	30	-19	\$ 229.00
S-NY-BPS-M030-20	1.34	34	-21	\$ 236.00
S-NY-BPS-M036-23	1.41	36	-23	\$ 242.00
S-NY-BPS-M039-26	1.62	41	-26	\$ 260.00
S-NY-BPS-M043-28	1.81	46	-29	\$ 277.00
S-NY-BPS-M047-30	2.10	53	-31	\$ 320.00

- Available By-The-Foot or in 100 foot coils.
- This sleeve is non-expandable – please measure your application carefully.

Spiral Wrap Hard Shell Hose and Cable Protection – Plasticised Cellulose Acetate



- Tuff-Wrap™ abrasion protection wrap is manufactured from highly impact resistant plasticised cellulose acetate, and is simply wrapped over hose or cable to provide a tough protection shell to reduce abrasion damage.
- This shell is much tougher than our HDPE or fabric abrasion protection sleeve and is ideal for harsh environments such as outdoor construction or where hoses and cables might be dragged repetitively over concrete plant floors. Rounded edges prevents hose and cable cover damage from flexing of spiral.
- Available in sizes to wrap individual or bundled hoses and cables with a total ID up to 6 inches or 152mm.
- Stays in place without sliding. Springs back when twisted and pulled. Rockwell hardness between 75-120. UV and ozone resistant.

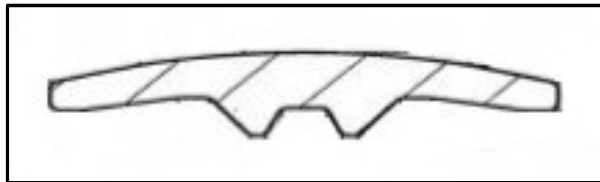

The unique profile shape of this product makes it a far superior spiral wrap to any flat profile wrap made of PE, PU or Nylon. Smooth rounded edges with a center double ridge on the inside of the profile and a curved shell allows the spiral to grip onto cables or hoses without damage but with flexibility.

Tuff-Wrap™ spiral wrap provides abrasion, scuff and wear resistance and helps to organize and bundle hoses and cables. Temperature range -30 to + 185°F continuous duty. This product is not self extinguishing.

Tuff-Wrap™ Heavy Duty Plasticized Cellulose Acetate Hard Shell Spiral Wrap for Abrasion Protection 40 foot standard lengths for sizes up to 1.75" ID / 25 foot lengths from 2.56" ID to 4" ID 15 foot standard length for 6" ID					
Part Number	ID Size			Pitch in inches	Price per Length Black / Yellow
	inch	mm	-dash		
SW-AP-PCA-M006-04-X	0.25	6	-04	0.25	\$ 49.20 / \$ 91.66
SW-AP-PCA-M008-05-X	0.325	8	-05	0.25	\$ 53.37 / \$ 91.66
SW-AP-PCA-M010-06-X	0.37	10	-06	0.25	\$ 57.75 / \$ 91.33
SW-AP-PCA-M013-08-X	0.50	13	-08	0.50	\$ 61.50 / \$ 98.89
SW-AP-PCA-M016-10-X	0.62	16	-10	0.50	\$ 66.50 / \$ 109.93
SW-AP-PCA-M019-12-X	0.75	19	-12	0.62	\$ 79.75 / \$ 126.84
SW-AP-PCA-M025-16-X	1.00	25	-16	0.62	\$ 119.00 / \$ 177.33
SW-AP-PCA-M028-18-X	1.10	29	-18	0.62	\$ 189.20 / \$ 301.33
SW-AP-PCA-M035-22-X	1.38	35	-22	0.67	\$ 245.00 / \$ 385.66
SW-AP-PCA-M044-28-X	1.75	44	-28	0.80	\$ 275.80 / \$ 415.33
SW-AP-PCA-M048-30-X	1.88	48	-30	0.80	\$ 275.80 / \$ 415.33
SW-AP-PCA-M067-42-X *	2.56	67	-42	1.37	\$ 307.75 / \$ 443.13
SW-AP-PCA-M080-50-X *	3.15	80	-50	1.37	\$ 356.00 / \$ 552.47
SW-AP-PCA-M090-57-X *	3.54	90	-57	1.37	\$ 381.57 / \$ 572.27
SW-AP-PCA-M102-64-X *	4.00	102	-64	2.00	\$ 415.50 / \$ 613.17
SW-AP-PCA-M152-96-X **	6.00	152	-96	2.00	\$ 496.00 / \$ 733.44

For the "X" value in the part number: Use "BK" for Black, "YL" for Yellow

Chemical Resistance: Water – very good; Ionic metallic solution – very good; gasoline – very good; oil – very good; mineral & vegetable oil – very good; Superior alcohols – very good; Acetone – poor; Methyl acetate – poor; Ethyl acetate – poor; Chlorine solvent – poor; Strong Acids and Strong Bases – may have some corrosive action; Inferior alcohols – after prolonged immersion may expand product but do not act as solvent.

Spiral Wrap Hard Shell Hose and Cable Protection – Plasticised Cellulose Acetate – High Temperature Version MSHA IC-207/5 Approved



- Tuff-Wrap™ abrasion protection wrap is manufactured from highly impact resistant plasticised cellulose acetate, and is simply wrapped over hose or cable to provide a tough protection shell to reduce abrasion damage.
- This shell is much tougher than our HDPE or fabric abrasion protection sleeve and is ideal for harsh environments such as mining, outdoor construction or where hoses and cables might be dragged repetitively over concrete plant floors. Rounded edges prevents hose and cable cover damage from flexing of spiral.
- Available in sizes to wrap individual or bundled hoses and cables with a total ID up to 6 inches or 152mm.
- Stays in place without sliding. Springs back when twisted and pulled. Rockwell hardness between 75-120. UV and ozone resistant.
- Both versions MSHA IC-207/5 approved.
- The unique profile shape of this product makes it a far superior spiral wrap to any flat profile wrap made of PE, PU or Nylon.

Tuff-Wrap™ spiral wrap provides abrasion, scuff and wear resistance and helps to organize and bundle hoses and cables. Temperature range -40°F to + 257°F (-30°C to +125°C) continuous duty (284°F peak).

Tuff-Wrap™ High Temperature Nylon Heavy Duty Hard Shell Spiral Wrap Abrasion Protection and bundling for Hoses, Wire and Cables 40 foot standard lengths – Color is Black					
Part Number	ID Size inch / mm / -dash			Pitch in inches	Price per Length
SW-AP-NY-HT-M010-06	0.37	10	-06	0.25	\$ 95.14
SW-AP-NY-HT-M013-08	0.50	13	-08	0.50	\$ 125.06
SW-AP-NY-HT-M016-10	0.62	16	-10	0.50	\$ 138.12
SW-AP-NY-HT-M019-12	0.75	19	-12	0.62	\$ 171.40
SW-AP-NY-HT-M025-16	1.00	25	-16	0.62	\$ 250.11
SW-AP-NY-HT-M028-18	1.10	29	-18	1.00	\$ 276.44
SW-AP-NY-HT-M035-22	1.38	35	-22	1.00	\$ 360.23
SW-AP-NY-HT-M035-22	1.96	50	-31	1.00	\$ 373.82
SW-AP-NY-HT-M035-22	2.36	60	-38	1.00	\$ 386.40
SW-AP-NY-HT-M035-22	3.15	80	-50	1.00	\$ 548.80
SW-AP-NY-HT-M035-22	3.54	90	-57	1.00	\$ 616.23

Standard length is approximately 39 feet.

HDPE Spiral Wrap Hard Shell Hose and Cable Protection SafeEdge™



- SafeEdge™ abrasion protection spiral wrap is manufactured from highly impact resistant high density polyethylene, and is simply wrapped over hose or cable to provide a tough protection shell to reduce abrasion damage.
- Rounded edges prevents hose and cable damage from flexing of spiral. Superior to cheaper spiral made from slit plastic pipe resulting in sharp edges.
- Available in sizes to wrap individual or bundled hoses and cables with a total ID up to 5 inches or 127mm.
- Stays in place without sliding. Springs back when twisted and pulled.
- Yellow and Black are available as standard colors. Other colors may be available from stock or by lot run.
- Temperature range -60 to + 175°F. Resistant to acids, oils and solvents.

SafeEdge™ High Density Polyethylene Hard Shell Spiral Wrap for Cable & Hose Abrasion Protection

Part Number	ID Size			Pitch in inches	Wall Thickness in inches	Coil Length Feet / Price per Coil
	inch	mm	-dash			
SW-HDP-AP-M010-07-XX	0.40	10	-07	0.4	.05	100 / \$ 193.00
SW-HDP-AP-M013-08-XX	0.50	13	-08	0.47	.05	100 / \$ 203.33
SW-HDP-AP-M016-10-XX	0.65	16	-10	0.8	.05	100 / \$ 220.00
SW-HDP-AP-M021-14-XX	0.80	21	-14	1.0	.10	100 / \$ 236.81
SW-HDP-AP-M027-17-XX	1.10	27	-17	0.9	.10	100 / \$ 267.46
SW-HDP-AP-M035-22-XX	1.40	35	-22	.94	.11	100 / \$ 396.84
SW-HDP-AP-M043-27-XX	1.70	43	-27	1.2	.13	100 / \$ 536.67
SW-HDP-AP-M056-35-XX	2.20	56	-35	1.5	.15	100 / \$ 736.71
SW-HDP-AP-M066-42-XX	2.60	66	-42	1.75	.17	75 / \$ 732.50
SW-HDP-AP-M081-51-XX	3.20	81	-51	1.75	.19	50 / \$ 646.64
SW-HDP-AP-M099-62-XX	3.90	99	-62	2.00	.22	50 / \$ 861.37
SW-HDP-AP-M114-72-XX	4.50	114	-72	2.04	.23	40 / \$ 874.91
SW-HDP-AP-M127-80-XX	5.00	127	-80	2.16	.25	30 / \$ 749.00

For the "XX" value in the part number: Use "BK" for Black, "YL" for Yellow

Special colors available:

OR for Orange, RD for Red, GR for Green, BL for Blue, GY for Grey, PR for Purple

Add 15% for special colors.

Special colors may be available from stock. If not, then a lot run is required.

Spiral Wrap – Mine Approved Hard Shell Hose and Cable Protection MSHA IC-271 SafeEdge™



- SafeEdge™ abrasion protection spiral wrap is manufactured from highly impact resistant high density polyethylene, and is simply wrapped over hose or cable to provide a tough protection shell to reduce abrasion damage.
- Rounded edges prevents hose and cable damage from flexing of spiral. Superior to cheaper spiral made from slit plastic pipe resulting in sharp edges.
- Available in sizes to wrap individual or bundled hoses and cables with a total ID up to 3.9 inches or 99mm.
- Stays in place without sliding. Springs back when twisted and pulled.
- MSHA IC-271 approved. Available only in a dark grey color.
- Temperature range -60 to + 175°F. Resistant to acids, oils and solvents.

SafeEdge™ High Density Polyethylene Hard Shell Spiral Wrap for Cable & Hose Abrasion Protection - MSHA IC-271 Approved						
See notes for available lengths						
Part Number	ID Size inch / mm / -dash			Pitch in inches	Wall Thickness in inches	Price per Foot
SW-HDP-MINE-0.50-M016-10-ZZZ	0.50	13	-08	0.8	.05	\$ 2.55
SW-HDP-MINE-0.63-M016-10-ZZZ	0.63	16	-10	0.8	.05	\$ 2.63
SW-HDP-MINE-0.81-M021-14-ZZZ	0.81	21	-14	1.0	.10	\$ 2.70
SW-HDP-MINE-1.06-M027-17-ZZZ	1.06	27	-17	0.9	.10	\$ 3.20
SW-HDP-MINE-1.36-M035-22-ZZZ	1.36	35	-22	.94	.11	\$ 3.83
* SW-HDP-MINE-1.70-M043-27-ZZZ	1.70	43	-27	1.2	.13	\$ 5.67
SW-HDP-MINE-2.20-M056-35-ZZZ	2.20	56	-35	1.5	.15	\$ 7.36
* SW-HDP-MINE-2.60-M066-42-ZZZ	2.60	66	-42	1.75	.17	\$ 13.27
SW-HDP-MINE-3.20-M081-51-ZZZ	3.20	81	-51	1.75	.19	\$ 20.90
SW-HDP-MINE-3.90-M099-62-ZZZ	3.90	99	-62	2.00	.22	\$ 30.26

* For SW-HDP-MINE-1.70-M043-27-ZZZ and SW-HDP-MINE-2.60-M066-42-ZZZ, use “025”, “050” or “100” for length in feet as the “ZZZ” value in the part number

For all other part numbers, the coil length is 82 feet (use 082 in the part number).

This product is made to order; typical production is 10 to 15 working days.
 Some stock lengths may exist - please call

Spiral Wrap with Wear Indicating Layer for Hose & Cable Protection TellTale™ Hard Shell Hose and Cable Protection

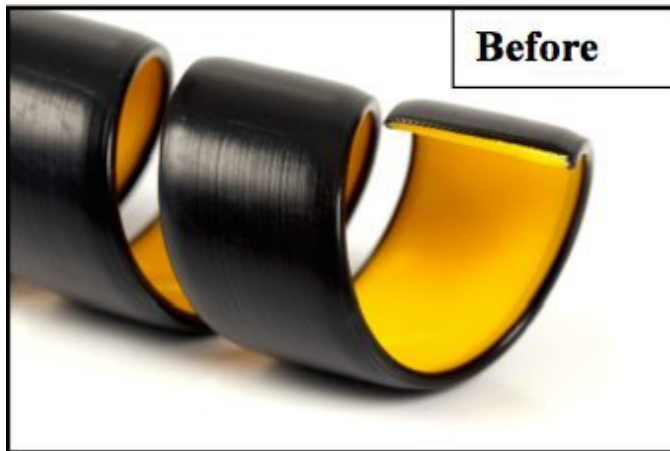

- TellTale™ abrasion protection spiral wrap is manufactured from highly impact resistant high density polyethylene, and is simply wrapped over hose or cable to provide a tough protection shell to reduce abrasion damage.
- Rounded edges prevents hose and cable damage from flexing of spiral. Superior to cheaper spiral made from slit plastic pipe resulting in sharp edges.
- Available in sizes to wrap individual or bundled hoses and cables with a total ID up to 2 inches or 51mm.
- Stays in place without sliding. Springs back when twisted and pulled.
- Made from two layers of different colored material; High wear areas identified by top layer revealing yellow base layer – identifies excessive wear problems before cable or hose damage has occurred.
- Temperature range -60 to + 175°F. Resistant to acids, oils and solvents.

TellTale™ High Density Polyethylene Hard Shell Spiral Wrap for Cable & Hose Abrasion Protection – With Wear Indicating Layer Lengths of 100 feet						
Part Number	ID Size inch / mm / -dash			Pitch in inches	Wall Thickness in inches	Price per Coil
SW-HDP-TELL-M016-10	0.63	16	-10	0.8	.05	\$ 220.00
SW-HDP-TELL-M021-17	0.81	21	-13	1.0	.10	\$ 237.00
SW-HDP-TELL-M027-22	1.06	27	-17	0.9	.10	\$ 267.00
SW-HDP-TELL-M035-27	1.36	35	-22	.94	.11	\$ 396.00
SW-HDP-TELL-M043-35	1.70	43	-27	1.2	.13	\$ 537.00

SafetyWrap™ Spiral Wrap for Hose & Cable Protection

High visibility protection with safety stripe reduces trip hazard

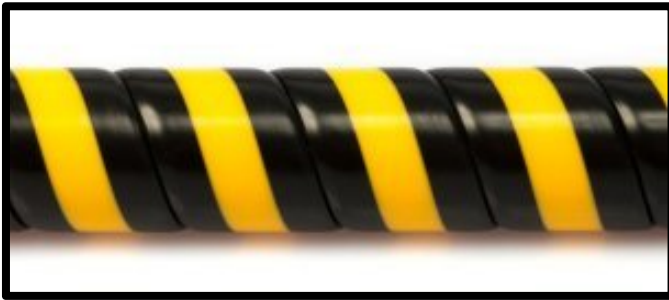

- SafetyWrap™ abrasion protection spiral wrap is manufactured from highly impact resistant high density polyethylene, and is simply wrapped over hose or cable to provide a tough protection shell to reduce abrasion damage.
- High visibility to reduce trip hazard.
- Rounded edges prevents hose and cable damage from flexing of spiral. Superior to cheaper spiral made from slit plastic pipe resulting in sharp edges.
- Used to wrap individual or bundled hoses.
- Stays in place without sliding. Springs back when twisted and pulled.
- Temperature range -60°F to + 175°F. Resistant to acids, oils and solvents.

SafetyWrap™ High Density Polyethylene Hard Shell Spiral Wrap for Cable & Hose Abrasion Protection – High Visibility

Lengths of 100 feet

Part Number	ID Size inch / mm / -dash			Pitch in inches	Wall Thickness in inches	Price per Coil
SW-HDP-SS-0.65-M016-10	0.65	16	-10	0.8	.05	\$ 192.00
SW-HDP-SS-0.80-M020-13	0.80	20	-13	1.0	.10	\$ 207.00
SW-HDP-SS-1.10-M028-18	1.10	28	-18	0.9	.10	\$ 234.00

Custom Fabrications & Fabrication Supplies

Welding Blankets & Curtains	7-1
Silica Plumber / Welder Pads	7-2
InSilMax Silica Kneeling Pads	7-3
Removable Blanket & Insulation for Exhaust Systems	7-4
Non Metallic Indoor/Outdoor Weatherproof Insulation Valves	7-9
Steel and Metal Processing Plant Custom Fabrications	7-10
Heated Removable Insulation Covers for Gas Cylinders	7-16
Heated Removable Insulation Covers and Heating Pads for Industrial Bulk Container Tote Tanks	7-17
55 & 30 Gallon Drum Insulated Covers & Covers with Heaters	7-18
ECO Blanket	7-19
Robotic Covers	7-20
Conveyor Belting	7-21
High Temperature Heat Resistant Threads	7-22
Hook & Loop Closure Fastener	7-27
High Temperature Zippers	7-29
Scissors / Shears / Cutters	7-30



Welding Blankets & Curtains. Page 7-1



Plumber/Welder Pads Page 7-2



Kneeling Pads Page 7-3



Exhaust System Removeable Blankets Page 7-4



Cable Track Protection Page 7-5



FestoonShield Protection Page 7-5



Lift Cylinder Bellows Protection Page 7-5



Weatherproof Insulation Page 7-6

Welding Blankets / Curtains

These blankets / curtains may be draped over equipment or cabling/hoses to protect against welding and grinding operations, or may be hung as a curtain to protect an area. May also be hung as a canopy or false ceiling to provide shielding from hot process piping or overhead repairs/fabrications.

Welding Blankets / Curtains		
Using FlameShield FCB 1000°F / 537°C Fabric		
Part Number	Size feet / metres	Price
CF-WBC-46-FB	4 x 6 / 1.2 x 1.8	\$ 125.43
CF-WBC-66-FB	6 x 6 / 1.8 x 1.8	\$ 156.80
CF-WBC-88-FB	8 x 8 / 2.4 x 2.4	\$ 278.90
CF-WBC-810-FB	8 x 10 / 2.4 x 3.0	\$ 348.60
CF-WBC-1010-FB	10 x 10 / 3.0 x 3.0	\$ 435.77
CF-WBC-1015-FB	10 x 15 / 3.0 x 4.5	\$ 653.67

Using FlameShield FCBHT (pre-shrunk) 1000°F / 537°C Fabric		
CF-WBC-66-FBHT	6 x 6 / 1.8 x 1.8	\$ 188.16
CF-WBC-88-FBHT	8 x 8 / 2.4 x 2.4	\$ 334.68
CF-WBC-810-FBHT	8 x 10 / 2.4 x 3.0	\$ 418.32
CF-WBC-1010-FBHT	10 x 10 / 3.0 x 3.0	\$ 522.92
CF-WBC-1015-FBHT	10 x 15 / 3.0 x 4.5	\$ 784.40

Using InSiMax ISCB 1800°F / 982°C Fabric		
CF-WBC-66-ETB90	6 x 6 / 1.8 x 1.8	\$ 350.73
CF-WBC-88-ETB90	8 x 8 / 2.4 x 2.4	\$ 623.53
CF-WBC-810-ETB90	8 x 10 / 2.4 x 3.0	\$ 779.47
CF-WBC-1010-ETB90	10 x 10 / 3.0 x 3.0	\$ 974.30
CF-WBC-1015-ETB90	10 x 15 / 3.0 x 4.5	\$ 1461.43

- Meets NFPA 701 / CPAI-84
- All Welding Blankets / Curtains are fabricated from a single layer of material.
- All outside edges are serged / overlocked to prevent fraying.
- Folded / stitched edges are available at extra charge.
- 1/2" Grommets are available at \$8.00 each, at any spacing desired.

For Custom Sizes Please Enquire

Plumbing / Grinding / Light Welding Protection Pads

1800°F / 982°C InSilMax™ Fabric



These mini pads are fabricated from Extreme High Temperature InSilMax™ Cloth, with serged / overlocked edges to prevent fraying, and with one edge folded and sewn and also grommeted at two corners.

Can be hung or tacked behind welding, grinding or soldering work to protect walls, wiring, hoses, etc. from being damaged during maintenance or fabrication work.

Also used as annealing pads in tempering ovens for metal fabrications.

These pads pay for themselves very quickly by preventing costly damage that could have been easily avoided.

InSilMax™ Silica Cloth Plumber / Welder Pads		
Part Number	Size - Thickness inches	Price
FAB-WPI-810-090	8" x 10" / .090"	\$ 9.48
FAB-WPI-810-054	8" x 10" / .054"	\$ 8.17
FAB-WPI-1012-090	10" x 12" / .090"	\$ 12.87
FAB-WPI-1012-054	10" x 12" / .054"	\$ 11.48

High Temperature Heat Resistant Kneeling Pads

1800°F / 982°C InSilMax™



These kneeling pads are fabricated from Extreme High Temperature InSilMax™ Cloth, with Extreme High Temperature Silica Insulation sandwiched between the layers.

Very popular in steel plants, boiler industry, and can be used anywhere that a pad is required for personnel comfort and safety that will not burn and will withstand welding slag, grinding, torch flame and other hazards.

Three standard sizes are available or custom made to any size.

InSilMax™ ThermalShield Kneeling Pad		
Part Number	Size	Price
FAB-KPI-1818	18" x 18"	\$ 155.34
FAB-KPI-2424	24" x 24"	\$ 223.50
FAB-KPI-3636	36" x 36"	\$ 284.00

Annealing Pads for Glass and Metal Processing

1800°F / 982°C InSilMax™ Fabric



Annealing pads are fabricated to your custom size requirement.

For maximum life, the edges are serged/overlocked or folded and stitched.

Please contact us with dimensions required.

Removable Blanket and Insulation Systems for Engine & Generator Exhaust Components – UL2200 1200°F / 648°C

Diesel, Gasoline/Petrol and Gas Turbine Engines

Suitable for Land, Marine and Mobile Equipment – Insulating Blankets for Mufflers, Silencers, Turbo Chargers, Elbows, Flex Pipes, Straight Pipes and Flanges



- Removable blankets protect personnel from contact burns.
- Helps maintain exhaust temperature for better exhaust flow.
- Helps to keep engine/generator room, compartment or enclosure cooler.
- Meets MIL-I-24222; USCG 164.009; ASTM E84; UL 2200.
- Suitable for gasoline & diesel reciprocating engines. Higher temperature version available for gas turbine engines.
- Removable blanket sections are assembled with either locking wire or spring clips connecting the mushroom rivets or hook fasteners that are mounted on the blankets. (mushroom rivets visible on example at left.). Custom made to form fit components.
- Hot side layer is a stainless steel knitted mesh fabric to hold the insulation in place.
- The insulation is a DeltaGlass™ needled fiberglass felt. Typically 1" thick but can be thinner or thicker to accommodate particular thermal or dimensional requirements.
- Cold side cover fabric is typically a 2 side silicone rubber coated FlameShield™ fibreglass (silver/gray is standard, red and black available). Optionally a silicone rubber / aluminum film Dual-Coat™ coated fabric can be used or a one side coated AluMax™ aluminum film fabric.



For higher temperature operation on gas turbine engines; 1) the stainless knitted mesh is replaced with inconel mesh; 2) the needed DeltaGlass™ is replaced with needed InSiilMax™; 3) the cold side fabric may be replaced with an InSiilMax™ fabric.

Closure of the blankets is accomplished with stainless lock wire connecting the mushroom cap rivets. Other closure systems are available, such as spring, straps with high temperature hook and loop closure, turnbuckles or straps with D rings.

Laser etched data plates are affixed to each blanket section, identifying your order number and the component; allowing for easy future replacement if necessary.

See our web site for many examples of installations and for forms to record your equipment dimensions to email or fax to us for a quote.

Example Pricing on Next Page

Removable Blanket and Insulation Systems for Engine & Generator Exhaust Components – UL2200

1200°F / 648°C Diesel, Gasoline/Petrol and Gas Turbine Engines

Suitable for Land, Marine and Mobile Equipment – Insulating Blankets for Mufflers, Silencers, Turbo Chargers, Elbows, Flex Pipes, Straight Pipes and Flanges

Example Pricing

Removable Blankets for Schedule Pipe – Example Pricing		
Part Number	Size	Price
FAB-EE-1200-2IDX12	2" ID x 12" (Straight Pipe)	\$ 74.67
FAB-EE-1200-2IDX24	2" ID x 24" (Straight Pipe)	\$ 109.76
FAB-EE-1200-2IDX36	2" ID x 36" (Straight Pipe)	\$ 167.38
FAB-EE-1200-2IDX48	2" ID x 48" (Straight Pipe)	\$ 221.16
FAB-EE-1200-3IDX12	3" ID x 12" (Straight Pipe)	\$ 84.38
FAB-EE-1200-3IDX24	3" ID x 24" (Straight Pipe)	\$ 146.74
FAB-EE-1200-3IDX36	3" ID x 36" (Straight Pipe)	\$ 217.68
FAB-EE-1200-3IDX48	3" ID x 48" (Straight Pipe)	\$ 261.33
FAB-EE-1200-4IDX6	4" ID x 6" (Straight Pipe)	\$ 53.75
FAB-EE-1200-4IDX12	4" ID x 12" (Straight Pipe)	\$ 89.77
FAB-EE-1200-4IDX24	4" ID x 24" (Straight Pipe)	\$ 155.58
FAB-EE-1200-4IDX36	4" ID x 36" (Straight Pipe)	\$ 217.18
FAB-EE-1200-4IDX48	4" ID x 48" (Straight Pipe)	\$ 264.38
FAB-EE-1200-4IDX72	4" ID x 72" (Straight Pipe)	\$ 380.37
FAB-EE-1200-4IDL90R4	4" Short 90 Elbow R=4"	\$ 111.28
FAB-EE-1200-5IDX12	5" ID x 12" (Straight Pipe)	\$ 97.47
FAB-EE-1200-5IDX24	5" ID x 24" (Straight Pipe)	\$ 169.98
FAB-EE-1200-5IDX36	5" ID X 36" (Straight Pipe)	\$ 225.92
FAB-EE-1200-5IDX36	5" ID X 48" (Straight Pipe)	\$ 311.38
FAB-EE-1200-6IDX60	6" ID x 60" (Straight Pipe)	\$ 367.93
FAB-EE-1200-36X48	36" x 48" Pad	\$ 436.61

Note: 2" ID schedule pipe is 2.375" OD; 3" ID pipe is 3.5" OD; 4" ID pipe is 4.5" OD, etc.

Please use our templates on the following pages to submit your installation for a price quote.

We can also work from tables of dimensions, photos with dimensions annotated over the images, or sketches/drawings. See our website for more examples.

Example Pricing

Removable Blankets for Schedule Pipe – Example Pricing		
Part Number	Size	Price
FAB-EE-1200-24IDX60	24" ID x 60" (Straight Pipe)	\$ 996.67
FAB-EE-1200-14IDX60	14" ID x 60" (Straight Pipe)	\$ 641.52
FAB-EE-1200-10.75IDX60	10.75" ID x 60" (Straight Pipe)	\$ 597.21
FAB-EE-1200-4.5IDX72	4.5" ID x 72" (Straight Pipe)	\$ 397.55

Note: 2" ID schedule pipe is 2.375" OD; 3" ID pipe is 3.5" OD; 4" ID pipe is 4.5" OD, etc.

Please use our templates on the following pages to submit your installation for a price quote.

We can also work from tables of dimensions, photos with dimensions annotated over the images, or sketches/drawings. See our website for more examples.

Quote Request Forms for Engine Component Insulation Blankets

General Overview & Dimensions

EXHAUST SYSTEM DRAWING

A	
B	
C	
D	
E	
F	
G	
H	
i	
J	
K	
L	
M	
N	
O	
P	
Q	
R	
S	
T	
U	
V	
W	
X	
Y	
Z	

1. MAKE AND MODEL OF SILENCER? IS IT A SIDE INLET OR STRAIGHT THROUGH DESIGN?
2. IS THERE A DRAIN OR SPARK ARRESTOR ON THE SILENCER? LOCATE ON DRAWING.
3. LOCATE ALL HANGERS AND SUPPORTS ON DRAWING

PLEASE CIRCLE PIPE HANGER/SUPPORT BELOW

EXAMPLE 1

EXAMPLE 2

EXAMPLE 3

EXAMPLE 4

PLEASE CIRCLE SILENCER HANGER/SUPPORT BELOW

EXAMPLE 1

EXAMPLE 2

EXAMPLE 3

EXAMPLE 4

Notes: _____

Your Email Address: _____ Phone: _____
 Name: _____

Muffler / Silencer Dimensions Form for Insulation Blankets

REQUIRED SILENCER INFORMATION

Through Inlet/Outlet

ALL SILENCER VERSIONS

A	Ø	
B	Weld to weld length	
C	Inlet/outlet OD	
D	Outlet offset (0 if N/A)	

THRU INLET/OUTLET VERSION ONLY

E	Inlet offset (0 if N/A)	
F	Support 1 Offset (if applicable)	
G	Support 2 Offset (if applicable)	
H	Support Width	

SIDE INLET VERSION ONLY

I	Inlet offset	
J	Support 1 Offset (if applicable)	
K	Support 2 Offset (if applicable)	

Side Inlet

Muffler / Silencer Support Type and Bracket Location Dimensions

TYPICAL SILENCER HANGER/SUPPORT DRAWING

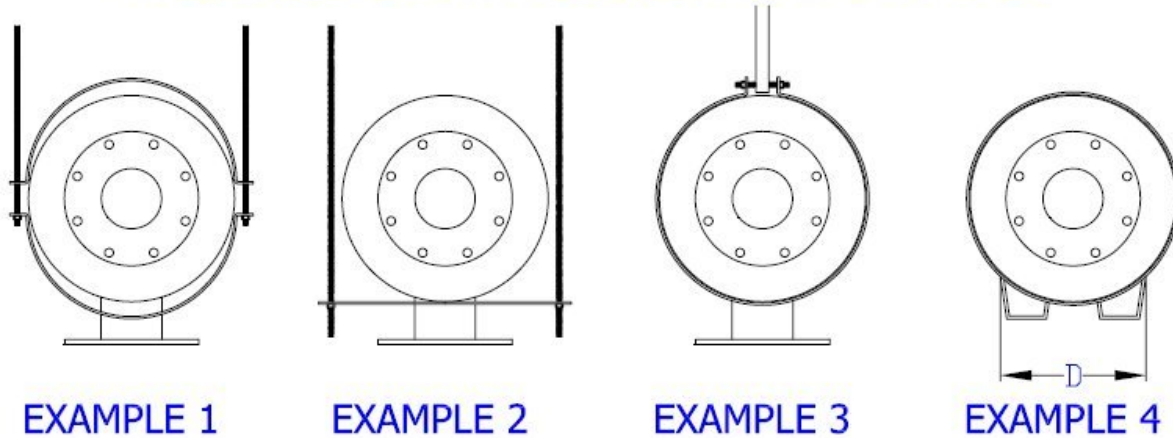

Please indicate the relevant support system.

Example of dimensions required to locate brackets

Through Inlet/Outlet

A	
B	
C	
D	

Side Inlet

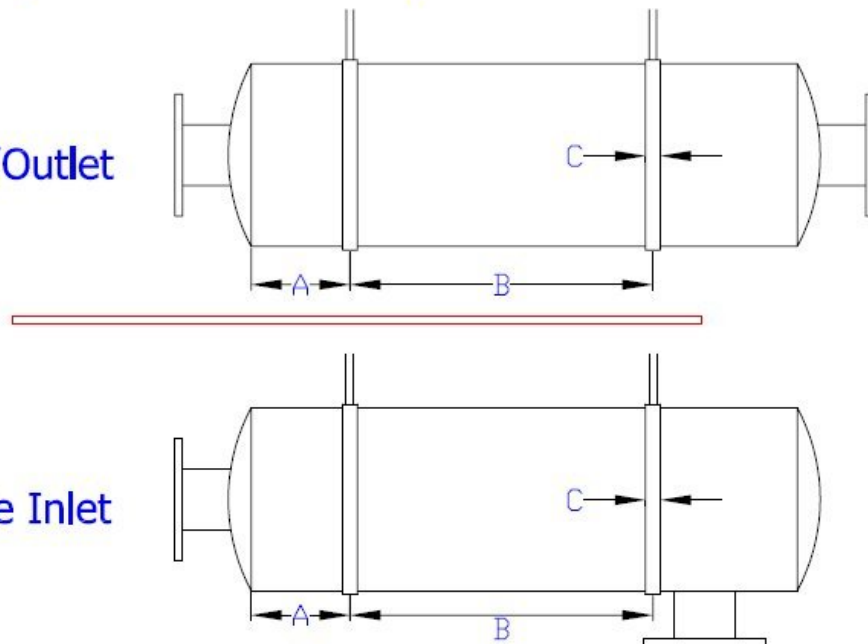

Flex, Flange and Elbow Dimensions for Insulation Blankets

REQUIRED INFORMATION FOR FLEXES, FLANGES, AND ELBOWS

FLEX AND FLANGES

FLEXES

A	OD	
B	LENGTH	

FLANGES

C	OD	
D	Flange Width	

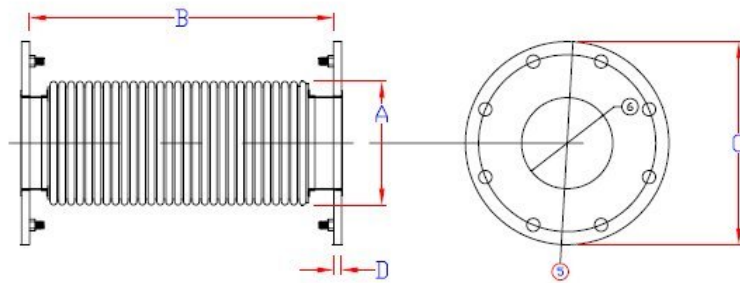

90° ELBOWS

A	OD	
B	Radius Length	
C	Extension 1	
D	Extension 2	

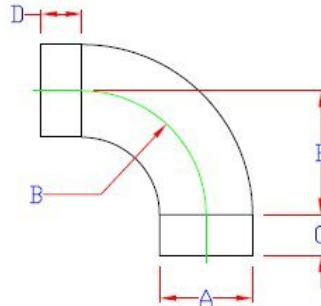

MISCILANEOUS ELBOWS

A	OD	
B	Angle (if known)	
C	Outer Arc Length	
D	Inner Arc Length	

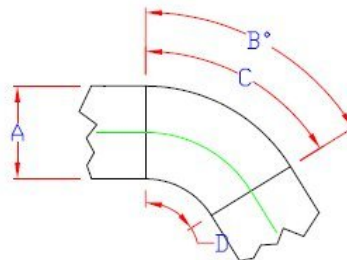

Turbo Charger Dimension Form for Insulation Blankets

AB Technology Group
 info@abthermal.com
 Fax 610-340-9054

GENERIC TURBO DIMENSION SHEET.

ENGINE MAKE:
 ENGINE MODEL:

1	
2	
3	
4	
5	
6	
7	
8	
9	
10	
11	
12	
13	
14	
15	

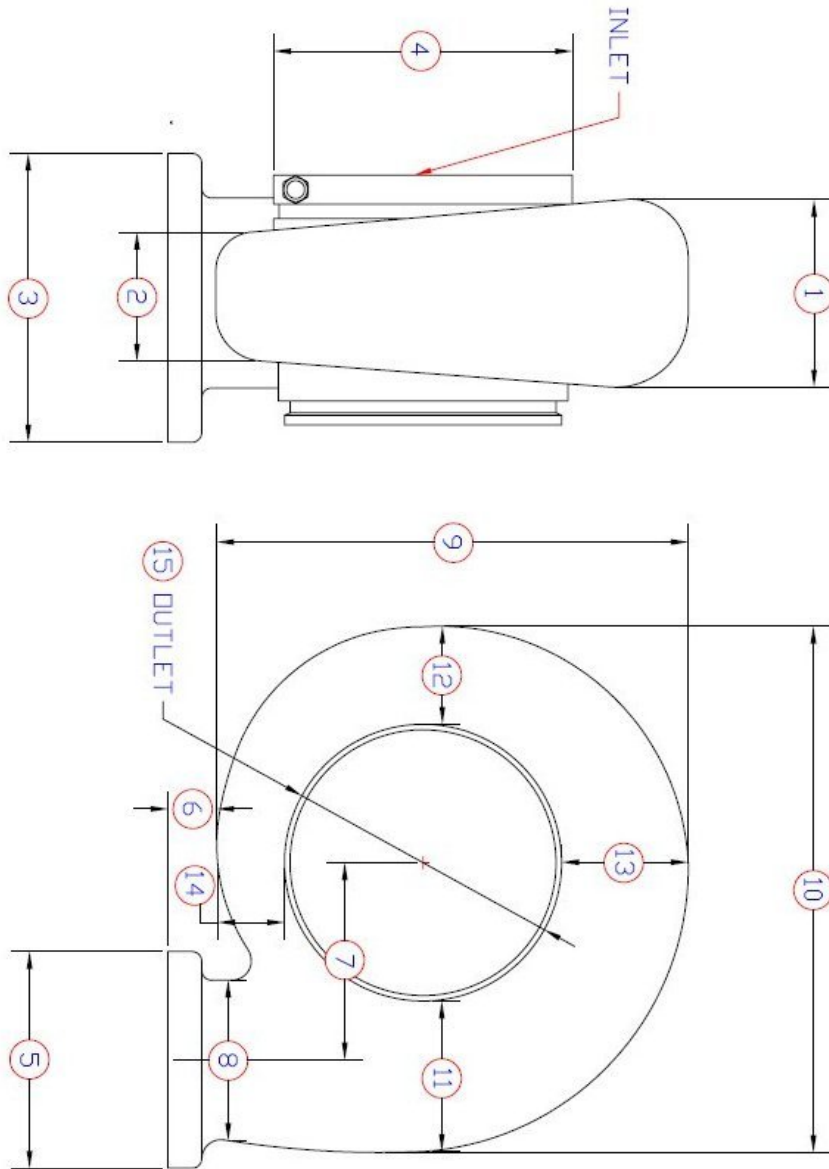

Fire Protection Removable Blanket and Shield Insulation Systems for Mine Equipment Engine Exhaust Components: 1200°F / 648°C ExhaustGuard™ For Mufflers, Silencers, Turbo Chargers, Elbows, Flex Pipes, Straight Pipes and Flanges

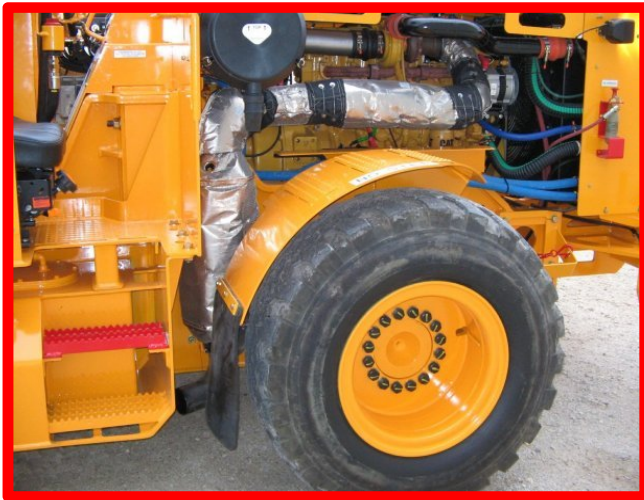

- Provides fire protection from fluid leaks and burst fuel and oil lines from contacting hot engine exhaust components.
- Two versions: ExhaustGuard Mine and MineXT. Mine version has a stainless inner liner to help prevent fluids from soaking the insulation layer. MineXT provides a stainless mesh outer cover to protect the outer fabric layer from tears and punctures.
- Meets MIL-I-24222; USCG 164.009; ASTM E84; UL 2200.
- Suitable for gasoline & diesel reciprocating engines.
- Custom made to form fit components.
- Removable blanket sections are assembled with either locking wire or spring clips connecting the hook fasteners that are mounted on the blankets.
- Collar system helps to prevent liquids from entering section gaps.



High Temperature Removable Insulation Covers for Industrial / Marine Valves and Piping – Indoor and Outdoor Heat Loss / Heat Gain / Freeze Protection for Ball / Butterfly / Gate Valves / Piping and Heat Exchangers

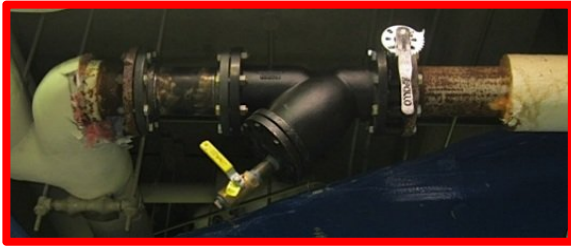

Custom fabricated removable insulation systems provide personnel protection, heat loss & heat gain protection, freeze protection. For heat loss and heat gain, energy savings payback is typically measured in months.

Various heat tapes with settable or fixed thermostat control are available for valve freeze protection covers. Outdoor covers feature hydrophobic insulation.

Blow-Out / Spray Protection Shields for Valves & Pipe Flanges

Blow-Out & Spray Protection Shields protect personnel and equipment from high pressure spray from failed gaskets and seals.

Reduces risk of injury.

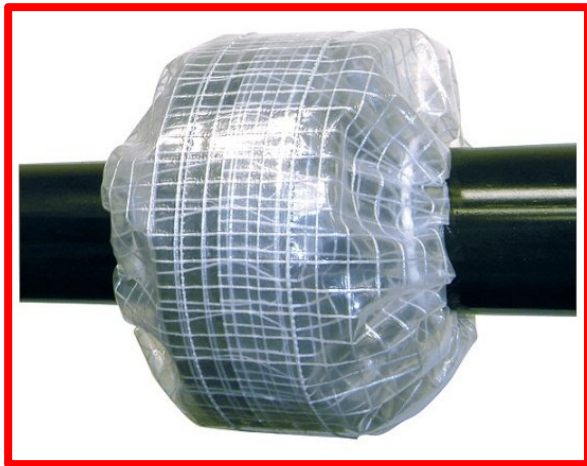

- Available in three versions:
 - 1) Ballistic Woven Nylon with polyurethane coating.
 - 2) High temperature ptfe coated fibreglass.
 - 3) Pure ptfe sheet.
- Pure ptfe sheet has greatest chemical compatibility range from ph 1 to 14. Temperature range -100°F to +550°F. FDA Approved. Translucent allows for easy visual inspection.
- Fiberglass coated with ptfe version for excellent chemical resistance.
- Nylon version meets EN982 ISO norm 833 & EN414 for hose blowout operator protection. Exceeds ISO 6945 abrasion standard and ISO 8031 conductivity standard.
- Easily installed and easily removed to allow for maintenance and inspection.
- Custom manufactured for any valve/flange size.
- Call for pricing.
- Part Number FAB-FSS-X-Y
"X" is the ANSI Flange size
"Y" is the material;
N for Nylon
PFG for PTFE coated fibreglass
PP for Pure PTFE

Steel and Metal Processing Plant Custom Fabrications

Festoon Protection Jacket Covers



Power Track Protection Jacket Systems



Bellows for Protecting Lift Cylinders



Heated Removable Insulation Covers for Gas Cylinders General Use and CSA Hazardous Area Approved (Class I, Division 1)



- Improves process control and reduces wasted condensed gas.
- Increases pressure.
- CSA rated for Class I Div 1, Groups B, C and D.
- Fits most gas cylinders.
- Self regulating 150 watts of heating.
- 2 inch side insulation; 0.5" top insulation.
- 10 foot power lead.
- Particularly useful for Propane, Nitrogen, Oxygen, SF6, BCl3, WF6 and HF gases.

ThermaCover™ Gas Cylinder Heaters – CSA Approved Hazardous Areas			
Part Number	Size inch / mm	Voltage	Price
FAB-HCW-8480-X	8 x 48 / 203 x 1219	120 / 240	\$ 1848.34
FAB-HCW-951-X	9 x 51 / 229 x 1295	120 / 240	\$ 1878.00
FAB-HCW-1047-X	10 x 47 / 254 x 1194	120 / 240	\$ 1898.00
FAB-HCW-1543-X	15 x 43 / 381 x 1092	120 / 240	\$ 2070.00

For the X value, specify "120" for 120 volt or "240" for 220-240 volt operation

ThermaCover™ Gas Cylinder Heaters – General Use Areas			
Part Number	Size inch / mm	Voltage	Price
FAB-GCW-8480-X	8 x 48 / 203 x 1219	120 / 240	\$ 819.34
FAB-GCW-951-X	9 x 51 / 229 x 1295	120 / 240	\$ 901.00
FAB-GCW-1543-X	15 x 43 / 381 x 1092	120 / 240	\$ 1109.00

For the X value, specify "120" for 120 volt or "240" for 220-240 volt operation

Other sizes and designs available

Heated Removable Insulation Covers and Heating Pads for Industrial Bulk Container Tote Tanks / Intermediate Bulk Containers



Heated Cover

- Helps speed the flow of high viscosity fluids such as oils, lubes, foods.
- Provides freeze protection.
- Does not contaminate or scorch product.
- Separate heat zones allows heat adjustment when the level lowers.
- Fits any tote tank from 40" (1016mm) x 40" (1016mm) to 48" (1219mm) x 48" (1219mm)
- Three standard heights: 36" (914mm), 42" (1067mm), 48" (1220mm)
- Adjustable thermostat 50° to 160°F
- Hi temperature safety cutoff at 195°F (91°C) for each zone
- Silicone rubber fabric resists contamination. Insulation layer ¼" thick
- Meets NEC 427.23 for ground safety.
- Wattage: 120VAC; 1440 watts / 240VAC; 2880 watts
- Optional insulated top cover for increased thermal protection.

Heating Pad

- Heating Pad Wattage: 120VAC 1600 watts / 240VAC 3240watts

ThermaCover™ Heated Insulation Covers & Heater Pads for Totes			
Part Number	Size inch / mm	Voltage	Price
FAB-TOTE-36-X	36" / 914mm height	120 / 240	\$ 1639.00
FAB-TOTE-42-X	42" / 1067mm height	120 / 240	\$ 1829.00
FAB-TOTE-48-X	48" / 1220mm height	120 / 240	\$ 1979.00
FAB-TOTE-COVER			\$ 235.00
FAB-TOTE-PAD-X	32" x 36" / 813mm x 914mm	120 / 240	\$ 1083.00

For the X value, specify "120" for 120 volt or "240" for 220-240 volt operation

55 & 30 Gallon Drum Insulated Covers 55 Gallon Drum Insulated Covers with Heaters



- Helps speed the flow of high viscosity fluids such as oils, lubes, foods.
- Provides freeze protection.
- Does not contaminate or scorch product.
- Dual heat zone version.
- Adjustable thermostat 50 to 160F
- Wattage:
55 gallon metal drums: 1600 watts
55 gallon metal drums with dual zone: 3200 watts
55 gallon poly drums: 770 watts
- Optional insulated top cover for increased thermal protection.
- High Temperature Silicone Rubber Coated Fiberglass Fabric with 1" thick fiberglass insulation.
- Designed for Indoor use.

ThermaCover™ Drum Insulated Covers		
Part Number	Size inch / mm	Price
FAB-DIN-55	55 gallon (208 litre)	\$ 452.68
FAB-DIN-30	30 gallon (114 litre)	\$ 412.34
FAB-DIN-TC55	Top Cover for 55 gallon drum	\$ 108.42

ThermaCover™ Drum Insulated Covers with Heaters			
Part Number	Size inch / mm	Voltage	Price
FAB-DIN-55MET-X	55 gallon / 1600 watt	120/240	\$ 979.00
FAB-DIN-55MET-DUAL	55 gallon / 3200 watt dual zone	240	\$ 1399.00
FAB-DIN-55POLY-X	770 watt	120/240	\$ 994.00

For the X value, specify "120" for 120 volt or "240" for 220-240 volt operation

Thermal Insulated Equipment Covers

500°F / 260°C: Eco-Blanket™ For Lab Ovens, Process Equipment, Test Equipment, Control Equipment



Photo shows cross section of construction method.

- Helps keep heat in or out.
- Saves energy.
- Silicone rubber coated fabric on both sides resists contamination. Insulation layer can be 1/4, 1/2 or 1" thick. Thicker available. PTFE coated fabric is also available
- Insulation is totally encased and prevented from movement by quilted sewing pattern.
- Other inner and outer fabric types available, such as PTFE coated, Aluminized PET Film coated.
- Variety of openings and access flaps available for exhaust gas, cooling flow, conduit, control panels, switches or valves.
- Can be sewn together to fit over or around equipment - or assembled in panels with snaps, zippers, straps, turnbuckles, hook and loop, etc.
- Silicone Fabric can be supplied in Industrial grade, or to meet MIL-I-24244, UL 214, NFPA 701, or NRC Guide 1.36 for flame, fire or smoke ratings.
- Silicone coated fabric available in standard weight of 17.5 oz/sq/yd or Heavy Duty 32 oz/sq/yd fabric.

For a quotation, please supply a sketch, dimensions, drawing or photo

Part Number will be FAB-ECSP-XXXX

Robotic Covers – Thermal Heat Process Protective; Welding Splatter/Slag and Grinding Spark and Debris Protective; Food Processing and Handling FDA Approved Custom Fitted



- Using a variety of outer fabrics, provides protection from heat, flame, weld splatter, slag, grinding spark and debris, fumes.
- FDA Approved materials for food processing and handling applications.
- Full rotational collars at strategic locations provides for full mobility.

Please Contact Us For Details

High Temperature Conveyor Belts

PTFE and Silicone Rubber Coated Fabrics – from .002 to .045 thickness
Light, Medium & Heavy Duty Coated or Porous



- We manufacture a variety of conveyor belts for applications such as screen printing, carpet fabrication, food processing, textile drying, etc.
- Splices available are Metallic, Non-Metallic and Endless.
- Tracking and Guides can be added to the belt, such as Guide Snaps, Grommets, or Silicone Rubber Guides.
- Edge Reinforcement can be heat-sealed edges, sewn & sealed fabric edge and heat sealed TFE Film edge.
- Two ply belts are available for packaging and heat-sealing applications.



How to Order a Belt – What We Need

- Dimensions of belt
- Splice Type
- Edge Reinforcement
- Tracking/Guides
- Pulley size and type
- Any special requirements



Please Contact Us With Your Belt Details for a Quotation

High Temperature Heat Resistant Sewing Thread

Kevlar® - Nomex® - Fiberglass - Quartz - Stainless



These threads are widely used in the fabrication and sewing of anything requiring high temperature capability. They are used in our own fabrication shops and we have years of experience in knowing what threads are used for which applications. Quality thread made in USA & Canada.

- Nomex® continuous is 662°F short term to 800°F.
- Kevlar® continuous is 320°F short term to 600°F.
- Fiberglass with pffe coating continuous is 1100°F short term to 1400°F.
- 304 / Inox Stainless continuous is 1200°F short term to 1400°F.
- Quartz continuous is 1800°F short term to 2000°F.
- Alumina continuous is 2200°F short term to 2300°F.

Kevlar® and Nomex® are registered trademarks of DuPont.

Filament Kevlar® High Temperature Heat Resistant Sewing Thread Meets MIL-T-87128 & A-A-55220



Kevlar is a high temperature resistant aramid fiber having a unique combination of toughness, high strength and thermal stability.

Both continuous multifilament and spun versions are available for a variety of sewing operations.

Continuous multifilament is available in both soft and bonded, but only in natural yellow color.

Spun thread is available in a range of dyed colors, and some of the larger sizes are also available glazed.

Excellent resistance to mildew and aging. Prolonged exposure to sunlight causes deterioration, but the fibers are self-screening. Good abrasion resistance.

FlameShield™ High Temperature & Heat Resistant Kevlar® Sewing Thread Filament Kevlar® - All Spools are 1 pound / 455 grams - Color Yellow

Part Number	MIL-T-87128 Designation	Size	TEX	Diameter inch	Break Strength, Lbs	Yards per Lb	Price per Spool.
FAB-TH-KF-40-X	B/2 (200 x 2)		40		14	10,000	\$ 198.77
FAB-TH-KF-60-X	E/3 (200 x 3)		60	.008	23	6,700	\$ 198.77
FAB-TH-KF-80-X	F/4 (200 x 4)		80		30	5,000	\$ 198.77
FAB-TH-KF-120-X	FF/3 (400 x 3)		120	.012	45	3,350	\$ 154.62
FAB-TH-KFB-160	N/A		160		57	2,368	\$ 310.63
FAB-TH-KF-210-X	3 (400 x 5)		210		64	2,000	\$ 154.62
FAB-TH-KF-400-X	5 (1000 x 4)		400		135	950	\$ 115.74
FAB-TH-KF-500-X	6 (1500 x 3)		500		150	850	\$ 96.91
FAB-TH-KF-800-X	8 (1500 x 5)		800		225	500	\$ 96.91

- For the "X" Value, Specify B for Bonded, or P for Plain. Add \$22.61 per spool for bonded
- Also meets A-A-55220

Kevlar® and Nomex® are registered trademarks of DuPont.

Spun Kevlar® High Temperature Heat Resistant Sewing Thread



Kevlar is a high temperature resistant aramid fiber having a unique combination of toughness, high strength and thermal stability.

Both continuous multifilament and spun versions are available for a variety of sewing operations.

Continuous multifilament is available in both soft and bonded, but only in natural yellow color.

Spun thread is available in a range of dyed colors, and some of the larger sizes are also available glazed.

Excellent resistance to mildew and aging. Prolonged exposure to sunlight causes deterioration, but the fibers are self-screening. Good abrasion resistance.

Spun Kevlar is in compliance with the Canadian Standards CAN/CGSB 155.1-98 and CAN/CGSB 155.22-97. Meets requirements of NFPA 1971-1991 Standard on Protective clothing and NFPA 1974-1994 Standard on Fire Fighters Uniforms.

Kevlar® is certified by Underwriters Laboratories Inc. for use in protective clothing.

FlameShield™ High Temperature & Heat Resistant Kevlar® Sewing Thread Spun Kevlar® - All Spools are 1 pound / 455 grams - Color Yellow

Part Number	Size	TEX	Diameter inch	Break Strength, Lbs	Yards per Lb	Price per Spool.
FAB-TH-KS-35-Y	30/2	35			12,000	\$ 139.44
FAB-TH-KS-40-Y	30/2	40	0.004"	7	12,000	\$ 155.30
FAB-TH-KS-50-Y	30/3	50			8,000	\$ 155.30
FAB-TH-KS-60-Y	30/3	60	0.006"	10	8,000	\$ 155.30
FAB-TH-KS-70-Y	30/4	70	0.007"	13	5,700	\$ 155.30
FAB-TH-KS-90-X-Y	30/5	90			5,000	\$ 139.44
FAB-TH-KS-100-X-Y	30/5	100	0.008"	17	4,800	\$ 155.30
FAB-TH-KS-105-X-Y	30/6	105			4,000	\$ 139.44

Kevlar® and Nomex® are registered trademarks of DuPont.

- For the "X" Value, Specify B for Glazed, or P for Plain. Add \$19.34 per spool for bonded
- For the "Y" Value, Specify N for Natural, and C for Colored. Add \$41.72 per spool for color.

Filament Nomex® and Spun Nomex® High Temperature Heat Resistant Sewing Thread

Meets MIL-T-83193B Type I



Nomex is a high temperature resistant fiber having a unique combination of toughness, high strength and thermal stability.

Both continuous multifilament and spun versions are available for a variety of sewing operations.

Continuous multifilament is available in both soft and bonded, but only in natural yellow color.

Spun thread is available in a range of dyed colors, and some of the larger sizes are also available glazed.

Excellent resistance to mildew and aging. Prolonged exposure to sunlight causes deterioration, but the fibers are self-screening. Good abrasion resistance.

FlameShield™ High Temperature & Heat Resistant Sewing Thread Filament & Spun Nomex

Part Number	Material	Size	TEX	Diameter inch	Break Strength, Lbs	Yards per Lb	Price per Spool.
FAB-TH-NS-27	Spun Nomex		27		1.6	14,000	\$ 126.74
FAB-TH-NS-35	Spun Nomex		35		2.0	12,000	\$ 126.74
FAB-TH-NS-40	Spun Nomex		40		2.8	9,300	\$ 126.74
FAB-TH-NS-50	Spun Nomex		50		3.0	8,200	\$ 126.74
FAB-TH-NS-70	Spun Nomex		70		4.5	6,200	\$ 126.74
FAB-TH-NS-25* #	Spun Nomex	25	90	0.009"	6	4,850	\$167.92
FAB-TH-NB-69-N %	Bonded Nomex	69	60	0.011"	7.2	7,000	\$ 287.58
FAB-TH-NB-70-X #	Bonded Nomex	70	70	0.013"	8	4,850	\$ 221.72

Complies with CAN/CGSB-155.1-98 / CAN/CGSB-155.22-97, Meets Mil-T-83193 & A-A-55217.
 % Meets A-A-50195, Mil-T-43436

Kevlar® and Nomex® are registered trademarks of DuPont.



High Temperature Heat Resistant Sewing Thread

Kevlar - Nomex - Fiberglass - Quartz - Stainless



FlameShield™ High Temperature & Heat Resistant Sewing Thread									
Part Number	Material	Size	TEX	Diameter inch	Spool Weight, Lbs	Break Strength, Lbs	Yards per Lb	Natural Color	Price per Spool.
FAB-TH-FG-12	E-Fiberglass**	12	150	0.015"	2	18	2700	Gray	\$ 248.44
FAB-TH-FG-18 ****	E-Fiberglass**	18	210	0.017"	2	24	1800	Gray	\$ 248.44
FAB-TH-FG-24 *****	E-Fiberglass**	24	300	0.020"	2	30	1300	Gray	\$ 248.44
FAB-TH-FGINC-18	Fiberglass w/inconel**	18	210	0.100"	2	24	1800	Gray	\$ Call
FAB-TH-FGINC-24	Fiberglass w/inconel**	24	300	0.130"	2	30	1300	Gray	\$ Call
FAB-TH-QTZ-12	Quartz	12	150	0.014"	1	18	3450	Tan	\$ 682.34
FAB-TH-QTZ-18	Quartz	18	210	0.017"	1	24	2300	Tan	\$ 682.34
FAB-TH-QTZ-24	Quartz	24	300	0.020"	1	30	1700	Tan	\$ 682.34
FAB-TH-SSK-1064	3 strand Inox Stainless - Kevlar wrapped	1064	120	0.007"	2	28	4200	Yellow	\$ 827.58
FAB-TH-SSP-1064	10 strand 304 Stainless - Polyester wrapped	1064	120	.0145"	2	8	2150	White	\$ 627.21
FAB-TH-AL-31	Alumina	30		.031"	0.75		750	White	\$556.43

● For the "X" value, Specify NAT for Natural, BLK for Black

* Available Natural, Black, Orange, Red, Green ** Coated with PTFE *** Meets A-A-55220 & MIL-T-87128

**** Meets MIL-Y-1140C (Form 1, Class C) ***** Meets MIL-C-20079 (Type 3, Class 3)

Complies with CAN/CGSB-155.1-98 / CAN/CGSB-155.22-97, Meets Mil-T-83193 & A-A-55217.

% Meets A-A-50195, Mil-T-43436



Hook and Loop Closure – Nylon / Nomex®



Nylon hook and loop closure with Urethane/Acrylic backcoat with Flame Retardant additive. 225°F / 107°C Continuous; 300°F / 148°C for up to 1 hour; 459°F / 237°C melting point. Color is black. Nomex® is rated - 70°F to 350°F (-56°C to 176°C)

Nylon meets the following specifications:

- MIL-F-21840 / A-A-55126 Type II Class I
- NFPA 1971-1991
- Automotive FMVSS 302
- FAA 25.853a (Aviation)
- Toxicity ATS1000 (Nylon only)

FlameShield™ Nylon Hook & Loop Flame Retardant Fastener					
Part Number	Material	Width	Reel length	Price per Reel	Price per Yard
FAB-VHL-NY-LOOP-10-B	Nylon	5/8"	50 yards	\$ 47.97	\$ 4.79
FAB-VHL-NY-HOOK-10-B	Nylon	5/8"	50 yards	\$ 47.97	\$ 4.79
FAB-VHL-NY-LOOP-12-B	Nylon	3/4"	50 yards	\$ 56.88	\$ 5.68
FAB-VHL-NY-HOOK-12-B	Nylon	3/4"	50 yards	\$ 56.88	\$ 5.68
FAB-VHL-NY-LOOP-16-B	Nylon	1"	50 yards	\$ 66.33	\$ 6.63
FAB-VHL-NY-HOOK-16-B	Nylon	1"	50 yards	\$ 66.33	\$ 6.63
FAB-VHL-NY-LOOP-32-B	Nylon	2"	50 yards	\$ 126.61	\$ 12.66
FAB-VHL-NY-HOOK-32-B	Nylon	2"	50 yards	\$ 126.61	\$ 12.66
FlameShield™ Nomex® Hook & Loop Fastener - White Color					
Transportation Use - Aviation / Rail / Ground / Marine					
Meets FAR 25.853 / Boeing DMS1982 Rev G / AA-55126B -70°F to 350°F (-56°C to 176°C)					
FAB-VHL-NM-HOOK-16	Nomex®	1	50 yards	\$ 337.50	\$ 13.50
FAB-VHL-NM-LOOP-16	Nomex®	1	50 yards	\$ 466.20	\$ 18.65
FAB-VHL-NM-HOOK-32	Nomex®	2	50 yards	\$ 652.50	\$ 26.10
FAB-VHL-NM-LOOP-32	Nomex®	2	50 yards	\$ 765.00	\$ 30.60

FlameShield™ Nylon Hook & Loop Specification

Strength

Sample Condition

Dry (ASTM 5169 & 5170) Peel: 1.0 lb/in width Shear: 13.8 lb/in²

3 laundering (AATCC-61/3A)
plus 3 Dry Clean (AATCC-132) then 2,000 cycles

Peel: 0.67 lb/in width Shear: 8.3 lb/in²

Dimensions

Hook size: 8mil (.008") / 0.22 mm
Available Widths: 5/8", 3/4", 1", 1 1/2", 2", 4"
Hook Thickness: 0.077in (1.95mm)
Loop Thickness: 0.098 in (2.5mm)

Materials

Hook: Nylon, Woven
Backcoat: Urethane/Acrylic with F/R additive (type 2)
Hooks/in2: 220

Loop: Nylon, Woven
Backcoat: Urethane/Acrylic with F/R additive (type 2)

Properties

Sterilization: Gamma (Mrad): Yes
Autoclave: Yes

Chemical Resistance: **Acid** – Resistant to weak acids. Dissolved in mineral acids. Avoid concentrated acids
Alkali – Resistant to strong alkalis – recommend pH < 12.5 Temperature < 160°F
Oxidizers – Moderate resistance. Degraded by strong oxidizers. Keep temperature < 100°F
Solvents – Resistant to most common solvents. Less resistant to chlorinated solvents.

Fray Resistance: MIL F 21840: < 1/32 after 5 launderings

Operating Temperature: 225°F Continuous, 300°F < 1 hour, 459°F Melting Point

Shrinkage at boil: ASTM D2259; 1.5 – 2% at boil.

Certifications

MIL F 21840 / CID A-A-55126 Type II Class I

NFPA 1971 – 1991 Approved: NFPA 1975, 1977, 1976, 1971

Flammability: Automotive / FMVSS 302
FAA / 25.853B

Toxicity: ATS1000

Hook and Loop Closure – Stainless Steel

Heat, Flame and Chemical Resistant



Stainless Steel hook & Loop – heat and chemical resistance

-70°F to 800°F (-56°C to 426°C)

- MIL-F-21840 / A-A-55126 Type II Class I
- NFPA 1971-1991
- Automotive FMVSS 302
- FAA 25.853a (Aviation)

FlameShield™ Stainless Steel Yarn Hook & Loop Fastener					
Flame / Fire / Chemical Resistant					

Part Number	Material	Width	Reel length	Price per Reel	Price per Yard
FAB-VHL-SS-HOOK-16	Stainless Steel	1	25 yards	\$ 1247.00	\$ 96.87
FAB-VHL-SS-LOOP-16	Stainless Steel	1	25 yards	\$ 1247.00	\$ 96.87

High Temperature Heat & Flame Resistant Zippers

Metal teeth mounted on Nomex[®] support tape
 Maximum temperature 650°F / 343°C

Meets NFPA 1971, 1975, 1977, 1951, 1999
 CGSB 155.1, 155.2, 155.22. ASTM F1506, 1891. NFPA 70E, 2112, FMVSS 302 (Automotive),
 25.853B FAA

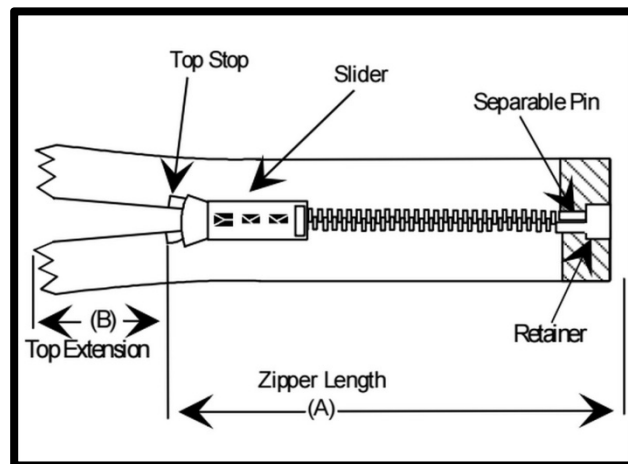

Brass Elements (Top Stop, Teeth, Slider, Retainer Ends) except slider spring and lock pin are stainless steel. Mounted on Nomex[®] tape.

Made to custom length:

Minimum length 8 inches. Maximum length 100 inches. Top extension 1 inch. Width 1 1/8 inch.

Minimum order is \$100 – sizes may be mixed.

FlameShield™ High Temperature & Flame Retardant Zipper	
Part Number	Price per Foot
FAB-ZIP-X	\$ 3.31

- For the “X” value, Specify length in inches

Delivery time approximately 4 weeks

Scissors / Shears / Cutters

Designed for cutting of Sleeve, Tape, Rope & Fabrics

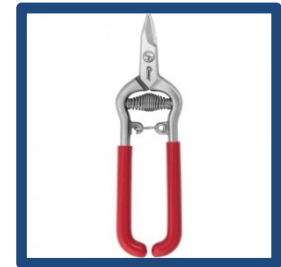
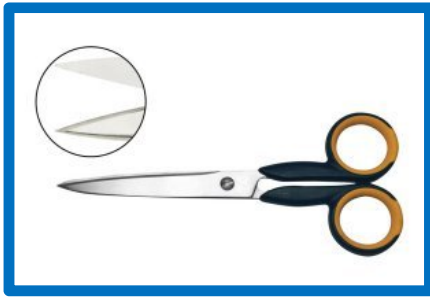

Scissors- Shears for Cutting and Trimming					
Part Number	Type	Blade	Length	Cutting Length	Price
Kevlar Cutting					
TL-S-KEV-104	Snips	Straight – 1 serrated	6 ½"	0.875"	\$ 51.66
TL-S-KEV-2715	Scissors	Straight – 1 serrated	6"	2.6"	\$ 26.00
TL-S-KEV-2915	Scissors	Straight – 2 serrated	6"	2.6"	\$ 28.00
TL-S-KEV-2720	Offset Shear	Straight – 1 serrated	8"	3.3"	\$ 28.00
TL-S-KEV-2920	Offset Shear	Straight – 2 serrated	8"	3.3"	\$ 30.00
TL-S-KEV-HD-4720	HD Offset Shear	Straight – 1 serrated	8"	3.5"	\$ 64.00
TL-S-KEV-HD-4920	HD Offset Shear	Straight – 2 serrated	8"	3.5"	\$ 66.00
TL-S-KEV-HD-3725	HD Offset Shear	Straight – 1 serrated	10"	4.9"	\$ 52.00
TL-S-KEV-HD-3925	HD Offset Shear	Straight – 2 serrated	10"	4.9"	\$ 54.00
TL-S-KEV-HD-4730	HD Offset Shear	Straight – 1 serrated	12"	5.5"	\$ 77.00
TL-S-KEV-HD-4930	HD Offset Shear	Straight – 2 serrated	12"	5.5"	\$ 79.00

These scissors and shears are suitable for cutting most of our fiberglass, silica and ceramic products such as sleeve, tape, rope and fabric, plain and coated. They are especially useful for cutting Kevlar.

Kevlar products are difficult to cut due to their strength. Regular or heavy duty scissors can sometimes cut these materials, but often fail quickly as the Kevlar quickly dulls the cutting edge.

Kevlar Shears are specifically designed to cut Kevlar, and feature either one serrated blade or two serrated blades so that the fibers don't slip while cutting, holding the fiber in position and allowing for a greater shear force to be applied by the opposing blade.

These shears are Extra Heavy Duty, and can be used for other materials such as cutting steel wires and steel tie wraps.

The shears highlighted in **Yellow** are our most popular selling models for all fabric, sleeve and tape materials, and especially for Kevlar.

Stainless Steel Snaps

FlameShield™ Snap Caps, Posts, Sockets, Studs & Setting Tools

Meets MIL-10884, MS27980 Style 2



Used to make fabrications and covers.

A set comprises a Cap / Socket on one side of the fabrication and a Post / Stud or a Screw Stud on the other side of the component.



- Standard material is Stainless Steel; other finishes such as Brass and Nickel Plate is available

- Standard Cap diameter is 0.6" / 15.24mm. Smaller is available

- Standard stud height is 0.24" / 6.1mm and is self piercing so no pre-punching of attached material is required.



FlameShield™ Snap Caps, Posts, Sockets, Studs & Setting Tools				
Part Number	Material	Diameter inch / mm	Height inch / mm	Price
FAB-SNAP-SS-CAP	Stainless Steel	.6 / 15.24	.24 / 6.1	\$ 27.00 / 100 pack
FAB-SNAP-SS-SOCKET	Stainless Steel			\$ 15.00 / 100 pack
FAB-SNAP-SS-POST	Stainless Steel	.555 / 14.10	.24 / 6.1	\$ 27.00 / 100 pack
FAB-SNAP-SS-STUD	Stainless Steel			\$ 15.00 / 100 pack
FAB-SNAP-BTOOL	Bench Tool			\$ 319.66
FAB-SNAP-HTOOL	Hand Tool			\$ 307.72
FAB-SNAP-DIESET	Die Set			\$ 107.62

Please inquire about screw studs

Commercial Kitchen Duct Sealant & Gaskets

Generally, most city and municipal codes and regulations call for gaskets that are used within commercial kitchen ducts must withstand 1500°F exposure.

Most duct work is fabricated in 4 construction styles:

1. Butt fit duct with offset flange lip
2. Overlap fit
3. Butt fit with flush flange lips
4. Cone flange (fan unit attachment)

Traditional high temperature fabric gaskets can be used successfully by utilizing a high temperature non-flammable sealant to form a barrier.

DuctSeal™ high temperature paste sealant will withstand continuous exposure to 460°F, and provides a flexible barrier to grease migration into the flange gasket. In the event of a fire, the sealant will break down into silicon dioxide, a white –grey powdery refractory insulating material. Even with the sealant deteriorated, the high temperature gasket remains in place and provides the barrier to flame migration through the duct flange joint. DuctSeal™ paste must not be used as the primary seal/gasket on the duct flange surfaces – a separate high temperature gasket must be used in conjunction with DuctSeal™ paste.

As most duct flanges are fastened together with ¼" carbon steel or stainless steel bolts and associated hardware, and most flanges are 1", 1 ¼" or 1 ½" wide, the easiest gasket to use is a LadderTape gasket, which has a loose ladder construction in the center of the tape to allow for easy passing of the fastening bolts through it.

Tapes are also available with a Pressure Sensitive Adhesive (acrylic) which allows for easy the installation of the tape.

DuctSeal™ gasket tapes are available in 1800°F, 2000°F and 2300°F versions. Most installers prefer the LadderTape™ version of the gasket for ease of installation, but some installers may prefer traditional plain tapes, one on each side of the bolt-hole line.

DuctSeal™ High Temperature Sealant / Paste: Commercial Kitchen Silicone Sealant



DuctSeal™ Paste Duct Flange Sealant Paste

This sealant is used to form a bead ahead of the gasket tape in the flange area of commercial kitchen grease ducts in order to keep grease from contaminating the gasket tape.

Can be used to 500°F continuous without degradation.

In the event of a fire, the elevated temperatures will decompose the sealant, turning it into a white insulating powder through a process called caramelization.

During the fire, the gasket tape itself will maintain the seal in the flange. The sealant is available in Oxide-Red and Black.



Available in two sizes:

- 3 oz squeeze tube.
P/N US-DSP-03-OR \$16.61
- 10.3 oz caulking gun cartridge.
P/N US-DSP-10-OR \$37.47

US-DSP paste meets the following specifications:

- MIL-A-46106A
- TT-S-001543A
- TT-S-00230C
- FDA Extractive Requirements CFR 177.2600
- USDA Rating P-1
- NSF/ANSI STD 51

DuctSeal™ Grease Duct Access Doors

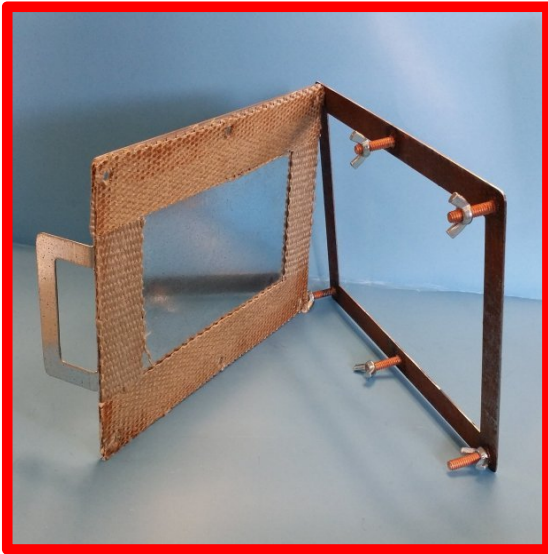

- Heavy Duty 16 gauge steel construction
- Stainless Steel models available
- Available with extended studs to accommodate fire wrap
- Back frame reinforces duct cut-out
- Easy to clean and install
- Standard and custom sizes available
- Gasket rated to 2300°F and is bonded to front panel

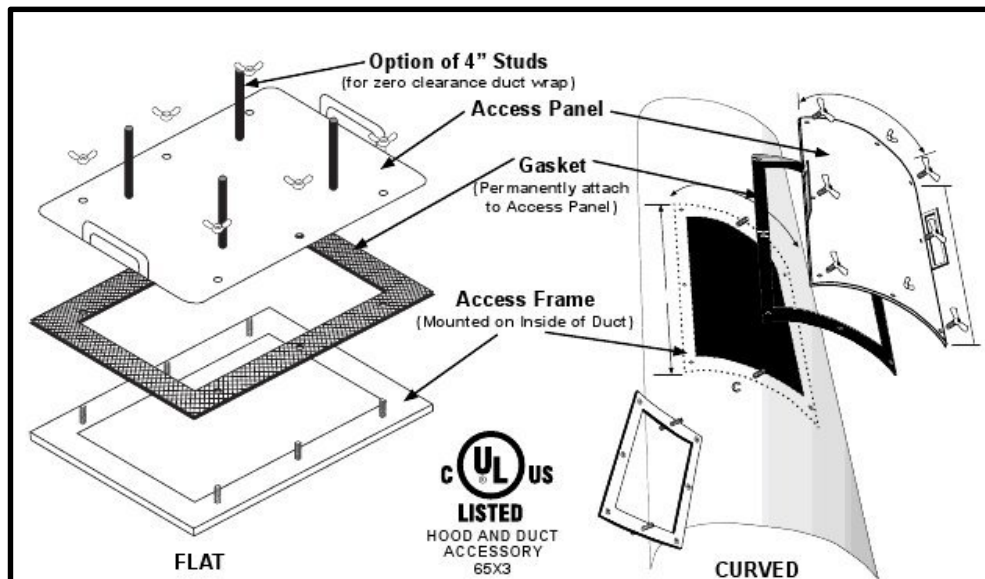

Pricing:

Flat Access Doors		Curved Access Doors	
DUCTDOOR-F-1	\$ 140.00	DUCTDOOR-C-1	\$ 216.00
DUCTDOOR-F-2	\$ 160.00	DUCTDOOR-C-2	\$ 216.00
DUCTDOOR-F-3	\$ 204.00	DUCTDOOR-C-3	\$ 288.00
DUCTDOOR-F-4	\$ 144.00	DUCTDOOR-C-4	\$ 220.00
DUCTDOOR-F-5	\$ 140.00	DUCTDOOR-C-5	\$ 272.00
DUCTDOOR-F-6	\$ 160.00	DUCTDOOR-C-6	\$ 276.00
DUCTDOOR-F-7	\$ 208.00	DUCTDOOR-C-7	\$ 284.00
DUCTDOOR-F-8	\$ 188.00	DUCTDOOR-C-8	\$ 298.00
DUCTDOOR-F-9	\$ 252.00	DUCTDOOR-C-9	\$ 312.00
DUCTDOOR-F-10	\$ 268.00	DUCTDOOR-C-10	\$ 298.00
DUCTDOOR-F-11	\$ 272.00	DUCTDOOR-C-11	\$ 364.00

Flat Doors

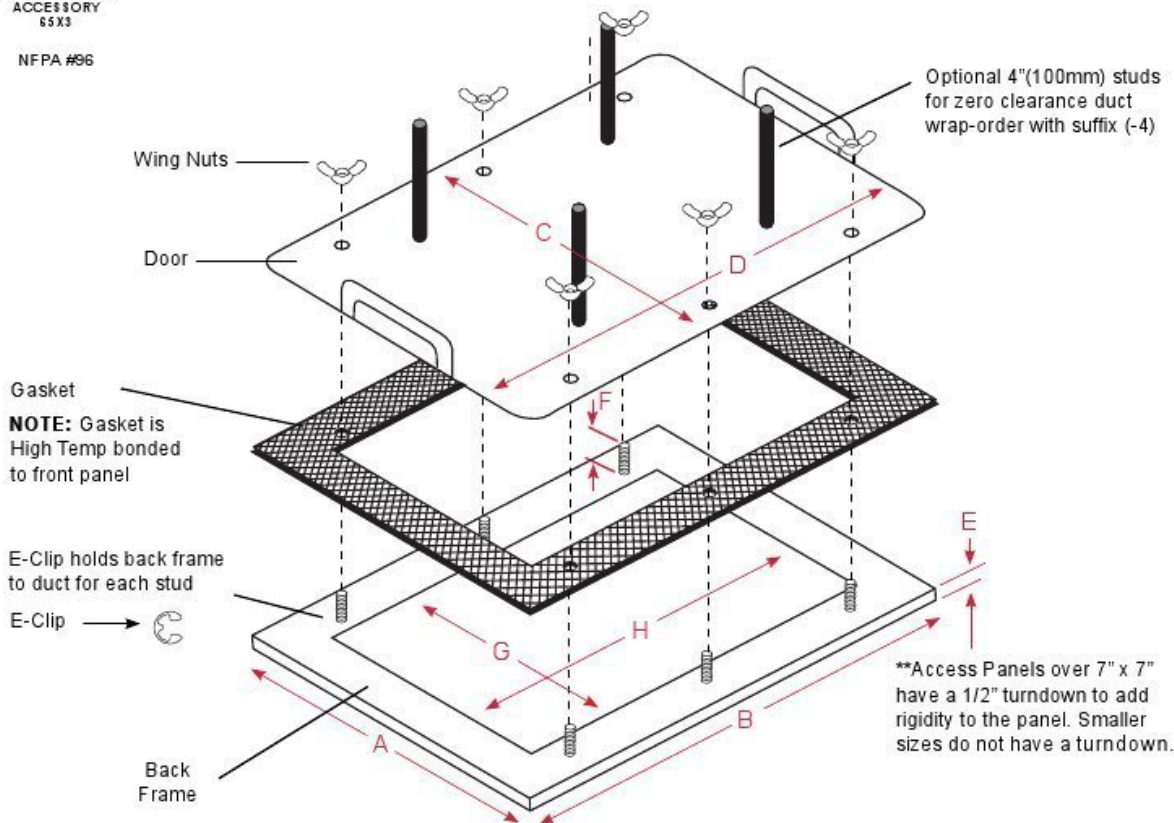

Please Order by Part No.	BACK FRAME OUTSIDE DIMENSION		FRONT PANEL OUTSIDE DIMENSION		PANEL WIDTH	STUD HEIGHT	HOLE SIZE • BACK FRAME INSIDE DIMENSION		MOUNTING STUDS
	A*	B*	C	D			G	H	
DUCTDOOR-F-1	7"	10"	7"	10"	Flat	1"	5.5"	8.5"	6
DUCTDOOR-F-2	7"	15"	7"	15"	Flat	1"	5.5"	13.5"	6
DUCTDOOR-F-3	7"	23"	7"	23"	Flat	1"	5.5"	21.5"	10
DUCTDOOR-F-4	8"	8"	8"	8"	Flat	1"	6"	6"	4
DUCTDOOR-F-5	10"	10"	10"	10"	.5"	1"	7"	7"	4
DUCTDOOR-F-6	10"	15"	10"	15"	.5"	1"	7"	12"	6
DUCTDOOR-F-7	10"	23"	10"	23"	.5"	1"	7"	20"	10
DUCTDOOR-F-8	15"	15"	15"	15"	.5"	1"	12"	12"	8
DUCTDOOR-F-9	15"	23"	15"	23"	.5"	1"	12"	20"	14
DUCTDOOR-F-10	19"	23"	19"	23"	.5"	1"	16"	20"	16
DUCTDOOR-F-11	23"	23"	23"	23"	.5"	1"	20"	20"	16

Curved Doors



NFPA #96

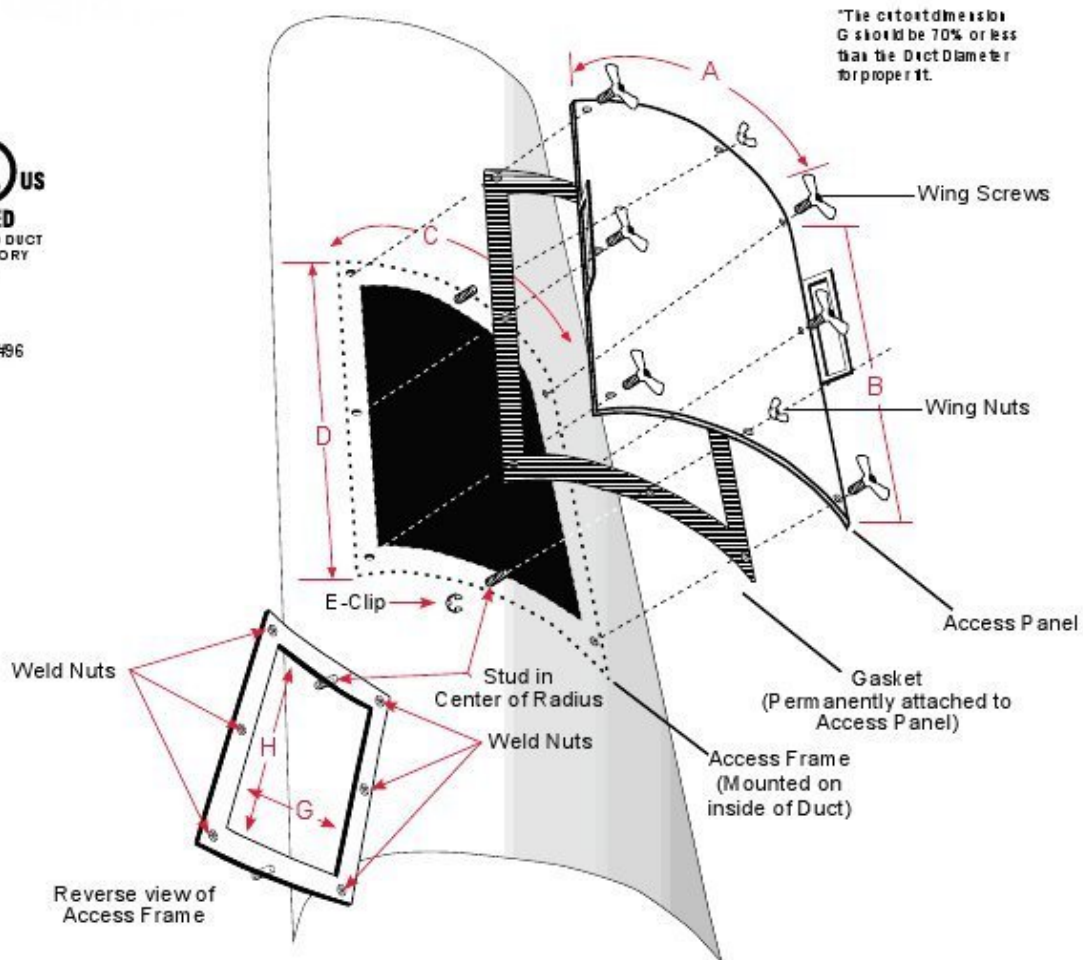

Please Order by Part No.	OUTSIDE DIMENSIONS				HOLE SIZE INSIDE DIMENSIONS	
	PART NO.	A	B	C	D	G ^A
DUCTDOOR-C-1	6.56"	6.75"	6.56"	6.75"	5.06"	5.25"
DUCTDOOR-C-2	6.50"	12.75"	6.50"	12.75"	5.00"	11.25"
DUCTDOOR-C-3	6.50"	18.75"	6.50"	18.75"	5.00"	17.25"
DUCTDOOR-C-4	9.50"	9.75"	9.50"	9.75"	8.00"	8.25"
DUCTDOOR-C-5	9.50"	12.75"	9.50"	12.75"	8.00"	11.25"
DUCTDOOR-C-6	9.50"	18.75"	9.50"	18.75"	8.00"	17.25"
DUCTDOOR-C-7	9.50"	24.75"	9.50"	24.75"	8.00"	23.25"
DUCTDOOR-C-8	12.50"	18.75"	12.50"	18.75"	11.00"	17.25"
DUCTDOOR-C-9	12.50"	24.75"	12.50"	24.75"	11.00"	23.25"
DUCTDOOR-C-10	18.50"	18.75"	18.50"	18.75"	17.00"	17.25"
DUCTDOOR-C-11	18.50"	24.75"	18.50"	24.75"	17.00"	23.25"

Custom Door Quote: Flat Doors



NFPA #86
UL FILE No. MH16475

MATERIAL:
BACK PLATE:
Cold Rolled Steel, Thickness – 0.057”(1.5mm)
FRONT PLATE:
Galvanized Steel, Thickness – 0.080”(1.5mm)

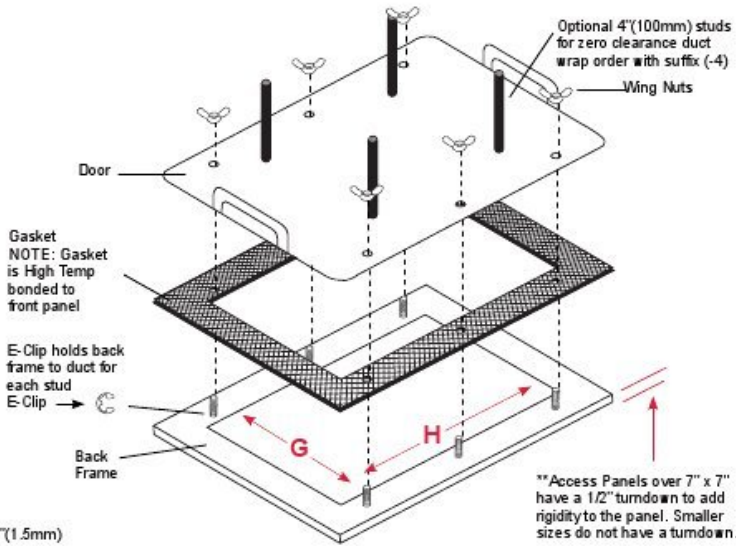

QUANTITY REQUIRED	
------------------------------	--

DIMENSIONS	SIZE	INCHES or MM
DIMENSION "G"		
DIMENSION "H"		

PANEL MATERIAL	Check One
GALVANIZED STEEL	<input type="checkbox"/>
STAINLESS STEEL 304	<input type="checkbox"/>
STAINLESS STEEL 316L	<input type="checkbox"/>

PANEL THICKNESS	Check One
.050" (1.3mm) S/S Models only	<input type="checkbox"/>
.060"(1.5mm)	<input type="checkbox"/>
.125"(3.2mm)	<input type="checkbox"/>

MOUNTING HARDWARE MATERIAL	Check One
ZINC PLATED STEEL	<input type="checkbox"/>
STAINLESS STEEL 304	<input type="checkbox"/>
STAINLESS STEEL 316L	<input type="checkbox"/>

Additional Notes

Date:	P.O. #	Account No:
Company Name:	Contact Name:	
Address:	City & State:	Zip:
Phone No:	E-mail:	

Custom Door Quote: Curved Doors



NFPA #96
UL FILE No. MH16475

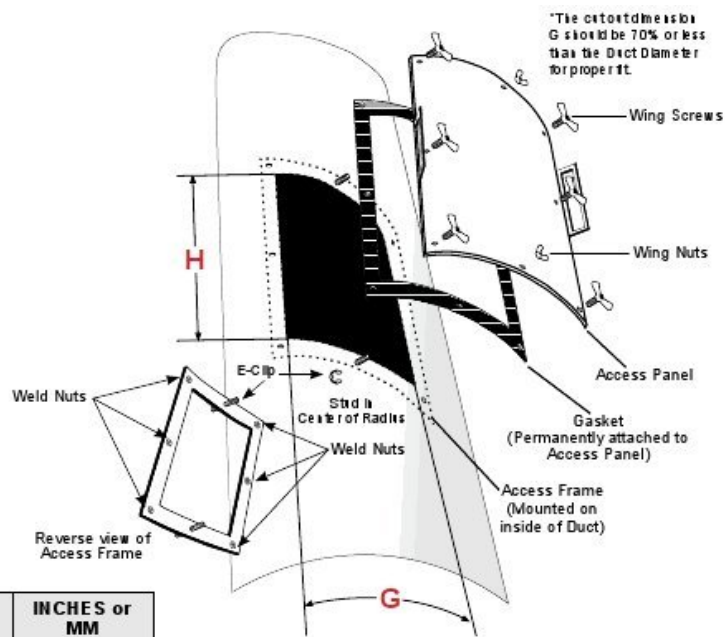

DIMENSIONS	SIZE	INCHES or MM
DUCT DIAMETER "A"		
CUT OUT DIMENSION "G" "G" = 70% x "A" or LESS		
IF LESS THAN 70% GIVE SIZE		
CUT OUT DIMENSION "H"		

NFPA 96 prohibits duct cut out greater than 70% of the duct diameter

QUANTITY REQUIRED	
-------------------	--

PANEL MATERIAL	Check One
GALVANIZED STEEL	<input type="checkbox"/>
STAINLESS STEEL 304	<input type="checkbox"/>
STAINLESS STEEL 316L	<input type="checkbox"/>

PANEL THICKNESS	Check One
.050" (1.3mm) S/S Models only	<input type="checkbox"/>
.060" (1.5mm)	<input type="checkbox"/>
.125" (3.2mm)	<input type="checkbox"/>

MOUNTING HARDWARE MATERIAL	Check One
ZINC PLATED STEEL	<input type="checkbox"/>
STAINLESS STEEL 304	<input type="checkbox"/>
STAINLESS STEEL 316L	<input type="checkbox"/>

Additional Notes

Date:	P.O. #	Account No:
Company Name:	Contact Name:	
Address:	City & State:	Zip:
Phone No:	E-mail:	

DuctSeal™ Applications:

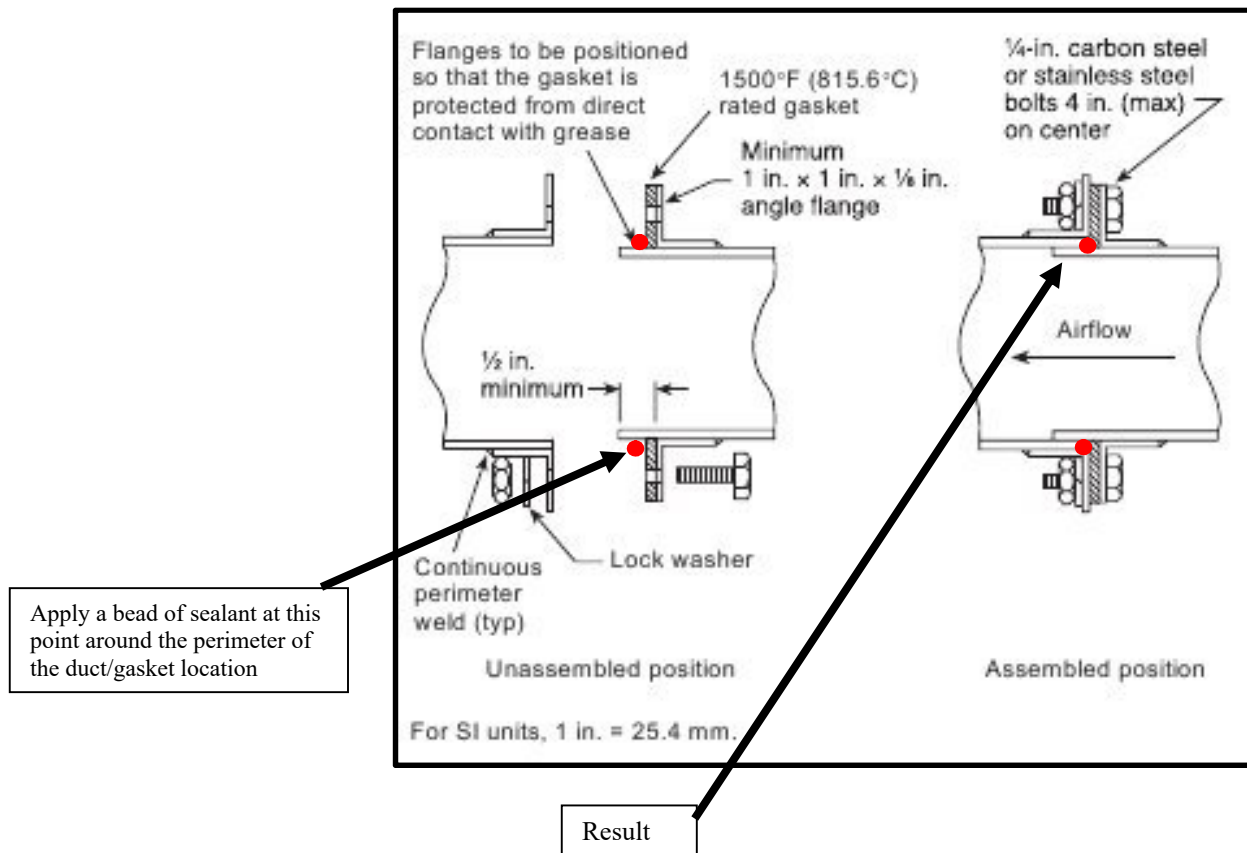
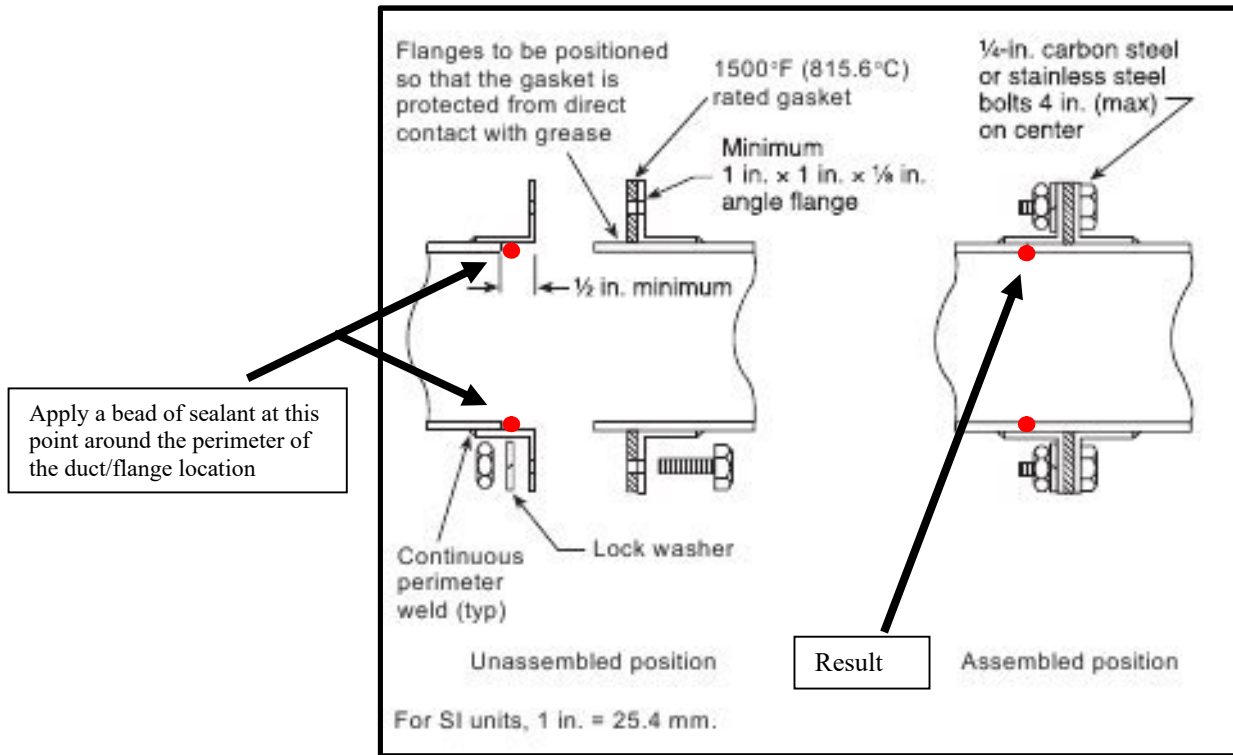

Apply a bead of sealant at this point around the perimeter of the flange, at the base of the gasket.

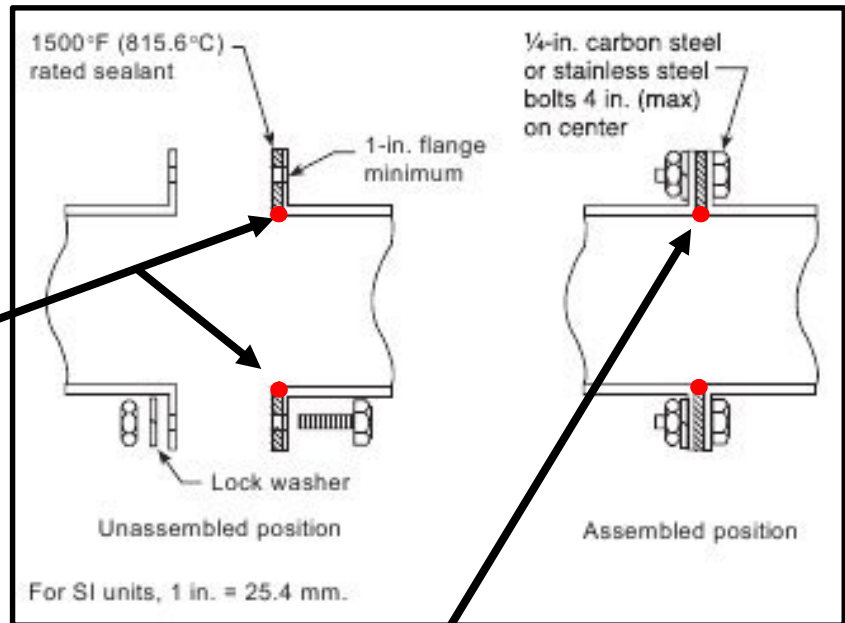

Result

Apply a bead of sealant at this point around the perimeter of the cone.

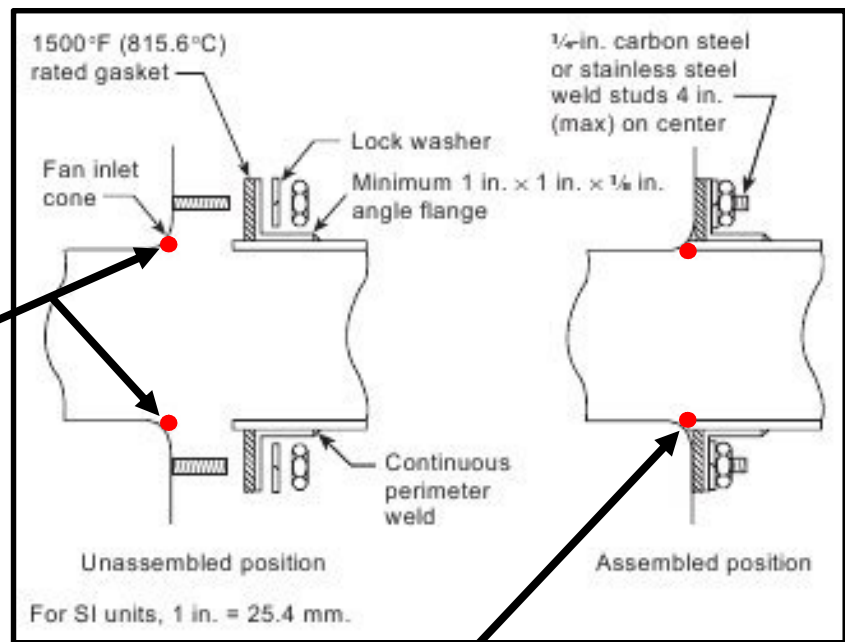

Result

High Temperature, Heat, Flame, Fire, Molten Metal & Weld Splatter Protection Materials

Fax Orders: 610-340-9054 Telephone Orders: 610-906-3549 orders@abthermal.com

Section 8

Ceramic Materials

Alumina High Temperature Non Conductive Fasteners – Bolts – Nuts - Washers	8-1
750°F / 400°C Glass-Ceramic Plate & Rod.....	8-2
1100°F / 593°C Glass-Ceramic Plate & Rod.....	8-2
Aluminum Silicate	8-3
Fired Alumina	8-4
Zirconium Phosphate	8-5
Boron Nitride / Aluminum Nitride	8-6
Alumina and Magnesium Oxide Crucibles	8-7

High Temperature, Heat, Flame, Fire, Molten Metal & Weld Splatter Protection Materials

Fax Orders: 610-340-9054 Telephone Orders: 610-906-3549 orders@abthermal.com

CerMax™ High Temperature Non Conductive Alumina & Zirconia Fasteners: Nuts, Bolts, Washers English & Metric



- High temperature use to 3000°F / 1649°C.
- English and Metric Sizes; Other sizes available.
- Alumina fasteners are 100% molded – then fired. No machining or grinding.
- Full Fired 99.8% Alumina & Zirconia, Non Conductive.
- **Minimum order is \$250.00 –mixing of pieces allowed**
- **All sales final. No warranty offered or implied**

CerMax™ High Temperature Non Conductive Ceramic Fasteners - Alumina							
English (Other Sizes Available – Please Ask)				Metric (Other Sizes Available – Please Ask)			
Part Number	Type	Size	Price	Part Number	Type	Size	Price
FST-CA-E-N-0-80	Nut	0-80	\$ 18.64	FST-CA-M-N-2	Nut	2 mm	\$ 20.60
FST-CA-E-N-2-56	Nut	2-56	\$ 19.80	FST-CA-M-N-3	Nut	3 mm	\$ 22.40
FST-CA-E-N-4-40	Nut	4-40	\$ 21.80	FST-CA-M-N-4	Nut	4 mm	\$ 24.80
FST-CA-E-N-5-40	Nut	5-40	\$ 22.08	FST-CA-M-N-5	Nut	5 mm	\$ 26.00
FST-CA-E-N-6-32	Nut	6-32	\$ 24.00	FST-CA-M-N-6	Nut	6 mm	\$ 27.60
FST-CA-E-N-8-32	Nut	8-32	\$ 25.00	FST-CA-M-N-8	Nut	8 mm	\$ 28.38
FST-CA-E-N-10-32	Nut	10-32	\$ 26.00				
FST-CA-E-N-1/4-20	Nut	1/4-20	\$ 27.00				
FST-CA-E-N-5/16-18	Nut	5/16-18	\$ 28.12				
FST-CA-E-N-3/8-16	Nut	3/8-16	\$ 29.12				
FST-CA-E-W-0-80	Washer	0-80	\$ 3.99	FST-CA-M-W-2	Washer	2 mm	\$ 5.20
FST-CA-E-W-2-56	Washer	2-56	\$ 4.15	FST-CA-M-W-3	Washer	3 mm	\$ 5.40
FST-CA-E-W-4-40	Washer	4-40	\$ 4.48	FST-CA-M-W-4	Washer	4 mm	\$ 6.40
FST-CA-E-W-5-40	Washer	5-40	\$ 4.65	FST-CA-M-W-5	Washer	5 mm	\$ 7.40
FST-CA-E-W-6-32	Washer	6-32	\$ 4.98	FST-CA-M-W-6	Washer	6 mm	\$ 7.66
FST-CA-E-W-8-32	Washer	8-32	\$ 5.31	FST-CA-M-W-8	Washer	8 mm	\$ 7.97
FST-CA-E-W-10-32	Washer	10-32	\$ 5.81				
FST-CA-E-W-1/4-20	Washer	1/4-20	\$ 6.16				
FST-CA-E-W-5/16-18	Washer	5/16-18	\$ 7.49				
FST-CA-E-W-3/8-16	Washer	3/8-16	\$ 8.32				

CerMax™ High Temperature Non Conductive Ceramic Fasteners - Zirconia							
English (Other Sizes Available – Please Ask)				Metric (Other Sizes Available – Please Ask)			
Part Number	Type	Size	Price	Part Number	Type	Size	Price
FST-CZ-E-N-2-56	Nut	2-56	\$ 27.06	FST-CZ-M-N-2	Nut	2 mm	\$ 26.56
FST-CZ-E-N-4-40	Nut	4-40	\$ 29.55	FST-CZ-M-N-3	Nut	3 mm	\$ 29.88
FST-CZ-E-N-6-32	Nut	6-32	\$ 31.54	FST-CZ-M-N-4	Nut	4 mm	\$ 34.36
FST-CZ-E-N-8-32	Nut	8-32	\$ 35.03	FST-CZ-M-N-5	Nut	5 mm	\$ 42.33
FST-CZ-E-N-10-32	Nut	10-32	\$ 40.50	FST-CZ-M-N-6	Nut	6 mm	\$ 48.14
FST-CZ-E-N-1/4-20	Nut	1/4-20	\$ 48.47	FST-CZ-M-W-2	Washer	2 mm	\$ 12.45
FST-CZ-E-W-2-56	Washer	2-56	\$ 12.78	FST-CZ-M-W-3	Washer	3 mm	\$ 14.94
FST-CZ-E-W-4-40	Washer	4-40	\$ 14.28	FST-CZ-M-W-4	Washer	4 mm	\$ 20.25
FST-CZ-E-W-6-32	Washer	6-32	\$ 17.43	FST-CZ-M-W-5	Washer	5 mm	\$ 25.56
FST-CZ-E-W-8-32	Washer	8-32	\$ 20.75	FST-CZ-M-W-6	Washer	6 mm	\$ 30.05
FST-CZ-E-W-10-32	Washer	10-32	\$ 24.90				
FST-CZ-E-W-1/4-20	Washer	1/4-20	\$ 29.71				

CerMax™ High Temperature Non Conductive Ceramic Fasteners - Alumina

English (Other Sizes Available – Please Ask)				Metric (Other Sizes Available – Please Ask)			
Part Number	Type	Size	Price	Part Number	Type	Size	Price
FST-CA-E-B-0-80x1/4	Bolt	0-80 x 1/4	\$ 28.72	FST-CA-M-B-2X5	Bolt	2 mm x 5 mm	\$ 35.00
FST-CA-E-B-2-56x1/4	Bolt	2-56 x 1/4	\$ 32.80	FST-CA-M-B-2X10	Bolt	2 mm x 10 mm	\$ 38.60
FST-CA-E-B-2-56x3/8	Bolt	2-56 x 3/8	\$ 35.00	FST-CA-M-B-3X5	Bolt	3 mm x 5 mm	\$ 38.80
FST-CA-E-B-2-56x1/2	Bolt	2-56 x 1/2	\$ 38.80	FST-CA-M-B-3X10	Bolt	3 mm x 10 mm	\$ 43.40
FST-CA-E-B-4-40x1/4	Bolt	4-40 x 1/4	\$ 34.80	FST-CA-M-B-3X20	Bolt	3 mm x 20 mm	\$ 47.00
FST-CA-E-B-4-40x3/8	Bolt	4-40 x 3/8	\$ 37.40	FST-CA-M-B-3X25	Bolt	3 mm x 25 mm	\$ 49.40
FST-CA-E-B-4-40x1/2	Bolt	4-40 x 1/2	\$ 41.40	FST-CA-M-B-4X5	Bolt	4 mm x 5 mm	\$ 43.20
FST-CA-E-B-4-40x3/4	Bolt	4-40 x 3/4	\$ 45.60	FST-CA-M-B-4X10	Bolt	4 mm x 10 mm	\$ 47.60
FST-CA-E-B-4-40x1	Bolt	4-40 x 1	\$ 48.00	FST-CA-M-B-4X20	Bolt	4 mm x 20 mm	\$ 51.80
FST-CA-E-B-5-40x1/4	Bolt	5-40 x 1/4	\$ 33.53	FST-CA-M-B-4X25	Bolt	4 mm x 25 mm	\$ 54.40
FST-CA-E-B-5-40x3/8	Bolt	5-40 x 3/8	\$ 36.02	FST-CA-M-B-4X30	Bolt	4 mm x 30 mm	\$ 56.80
FST-CA-E-B-5-40x1/2	Bolt	5-40 x 1/2	\$ 39.84	FST-CA-M-B-4X40	Bolt	4 mm x 40 mm	\$ 60.20
FST-CA-E-B-5-40x3/4	Bolt	5-40 x 3/4	\$ 43.33	FST-CA-M-B-5X5	Bolt	5 mm x 5 mm	\$ 46.20
FST-CA-E-B-5-40x1	Bolt	5-40 x 1	\$ 45.98	FST-CA-M-B-5X10	Bolt	5 mm x 10 mm	\$ 50.80
FST-CA-E-B-6-32x1/4	Bolt	6-32 x 1/4	\$ 38.40	FST-CA-M-B-5X20	Bolt	5 mm x 20 mm	\$ 54.60
FST-CA-E-B-6-32x3/8	Bolt	6-32 x 3/8	\$ 41.60	FST-CA-M-B-5X25	Bolt	5 mm x 25 mm	\$ 57.20
FST-CA-E-B-6-32x1/2	Bolt	6-32 x 1/2	\$ 46.20	FST-CA-M-B-5X30	Bolt	5 mm x 30 mm	\$ 59.80
FST-CA-E-B-6-32x3/4	Bolt	6-32 x 3/4	\$ 50.00	FST-CA-M-B-5X40	Bolt	5 mm x 40 mm	\$ 63.40
FST-CA-E-B-6-32x1	Bolt	6-32 x 1	\$ 52.40	FST-CA-M-B-6X5	Bolt	6 mm x 5 mm	\$ 49.00
FST-CA-E-B-8-32x1/4	Bolt	8-32 x 1/4	\$ 40.80	FST-CA-M-B-6X10	Bolt	6 mm x 10 mm	\$ 54.40
FST-CA-E-B-8-32x3/8	Bolt	8-32 x 3/8	\$ 43.80	FST-CA-M-B-6X20	Bolt	6 mm x 20 mm	\$ 58.40
FST-CA-E-B-8-32x1/2	Bolt	8-32 x 1/2	\$ 49.00	FST-CA-M-B-6X25	Bolt	6 mm x 25 mm	\$ 60.60
FST-CA-E-B-8-32x3/4	Bolt	8-32 x 3/4	\$ 53.00	FST-CA-M-B-6X30	Bolt	6 mm x 30 mm	\$ 63.80
FST-CA-E-B-8-32x1	Bolt	8-32 x 1	\$ 55.80	FST-CA-M-B-6X40	Bolt	6 mm x 40 mm	\$ 66.40
FST-CA-E-B-8-32x1-1/4	Bolt	8-32 x 1-1/4	\$ 58.00	FST-CA-M-B-6X50	Bolt	6 mm x 50 mm	\$ 69.80
FST-CA-E-B-8-32x1-1/2	Bolt	8-32 x 1-1/2	\$ 60.20	FST-CA-M-B-6X60	Bolt	6 mm x 60 mm	\$ 73.20
FST-CA-E-B-10-32x1/4	Bolt	10-32 x 1/4	\$ 42.60	FST-CA-M-B-6X75	Bolt	6 mm x 75 mm	\$ 77.40
FST-CA-E-B-10-32x3/8	Bolt	10-32 x 3/8	\$ 46.00	FST-CA-M-B-8X5	Bolt	8 mm x 5 mm	\$ 48.84
FST-CA-E-B-10-32x1/2	Bolt	10-32 x 1/2	\$ 51.00	FST-CA-M-B-8X10	Bolt	8 mm x 10 mm	\$ 55.11
FST-CA-E-B-10-32x3/4	Bolt	10-32 x 3/4	\$ 55.20	FST-CA-M-B-8X20	Bolt	8 mm x 20 mm	\$ 58.57
FST-CA-E-B-10-32x1	Bolt	10-32 x 1	\$ 58.40	FST-CA-M-B-8X25	Bolt	8 mm x 25 mm	\$ 60.22
FST-CA-E-B-10-32x1-1/4	Bolt	10-32 x 1-1/4	\$ 60.40	FST-CA-M-B-8X30	Bolt	8 mm x 30 mm	\$ 62.70
FST-CA-E-B-10-32x1-1/2	Bolt	10-32 x 1-1/2	\$ 62.80	FST-CA-M-B-8X40	Bolt	8 mm x 40 mm	\$ 65.84
FST-CA-E-B-1/4-20x1/4	Bolt	1/4-20 x 1/4	\$ 44.80	FST-CA-M-B-8X50	Bolt	8 mm x 50 mm	\$ 70.62
FST-CA-E-B-1/4-20x3/8	Bolt	1/4-20 x 3/8	\$ 48.40	FST-CA-M-B-8X60	Bolt	8 mm x 60 mm	\$ 74.09
FST-CA-E-B-1/4-20x1/2	Bolt	1/4-20 x 1/2	\$ 53.40	FST-CA-M-B-8X75	Bolt	8 mm x 75 mm	\$ 78.71
FST-CA-E-B-1/4-20x3/4	Bolt	1/4-20 x 3/4	\$ 58.00				
FST-CA-E-B-1/4-20x1	Bolt	1/4-20 x 1	\$ 60.80				
FST-CA-E-B-1/4-20x1-1/4	Bolt	1/4-20 x 1-1/4	\$ 63.00				
FST-CA-E-B-1/4-20x1-1/2	Bolt	1/4-20 x 1-1/2	\$ 65.20				
FST-CA-E-B-1/4-20x1-3/4	Bolt	1/4-20 x 1-3/4	\$ 68.00				
FST-CA-E-B-1/4-20x2	Bolt	1/4-20 x 2	\$ 70.80				
FST-CA-E-B-1/4-20x2-1/2	Bolt	1/4-20 x 2-1/2	\$ 73.20				
FST-CA-E-B-1/4-20x3	Bolt	1/4-20 x 3	\$ 76.00				
FST-CA-E-B-5/16-18x1/4	Bolt	5/16-18 x 1/4	\$ 43.82				
FST-CA-E-B-5/16-18x3/8	Bolt	5/16-18 x 3/8	\$ 47.47				
FST-CA-E-B-5/16-18x1/2	Bolt	5/16-18 x 1/2	\$ 52.62				
FST-CA-E-B-5/16-18x3/4	Bolt	5/16-18 x 3/4	\$ 56.61				
FST-CA-E-B-5/16-18x1	Bolt	5/16-18 x 1	\$ 59.43				
FST-CA-E-B-5/16-18x1-1/4	Bolt	5/16-18 x 1-1/4	\$ 61.09				
FST-CA-E-B-5/16-18x1-1/2	Bolt	5/16-18 x 1-1/2	\$ 63.25				
FST-CA-E-B-5/16-18x1-3/4	Bolt	5/16-18 x 1-3/4	\$ 66.07				
FST-CA-E-B-5/16-18x2	Bolt	5/16-18 x 2	\$ 68.89				
FST-CA-E-B-5/16-18x2-1/2	Bolt	5/16-18 x 2-1/2	\$ 73.37				
FST-CA-E-B-5/16-18x3	Bolt	5/16-18 x 3	\$ 76.69				
FST-CA-E-B-3/8-16x1/4	Bolt	3/8-16 x 1/4	\$ 46.15				
FST-CA-E-B-3/8-16x3/8	Bolt	3/8-16 x 3/8	\$ 49.80				
FST-CA-E-B-3/8-16x1/2	Bolt	3/8-16 x 1/2	\$ 54.95				
FST-CA-E-B-3/8-16x3/4	Bolt	3/8-16 x 3/4	\$ 59.26				
FST-CA-E-B-3/8-16x1	Bolt	3/8-16 x 1	\$ 61.42				
FST-CA-E-B-3/8-16x1-1/4	Bolt	3/8-16 x 1-1/4	\$ 63.58				
FST-CA-E-B-3/8-16x1-1/2	Bolt	3/8-16 x 1-1/2	\$ 66.23				
FST-CA-E-B-3/8-16x1-3/4	Bolt	3/8-16 x 1-3/4	\$ 68.56				
FST-CA-E-B-3/8-16x2	Bolt	3/8-16 x 2	\$ 71.21				
FST-CA-E-B-3/8-16x2-1/2	Bolt	3/8-16 x 2-1/2	\$ 75.20				
FST-CA-E-B-3/8-16x3	Bolt	3/8-16 x 3	\$ 79.35				

Strength - Alumina (A998)	
Bolt Size	Destructive Torque (in*lb) ¹
4-40	1.6
6-32	2.3
8-32	5.5
10-32	6.2
1/4-20	20.4
5/16-18	41.9
3/8-16	95

Strength Notes

- The data in the table is not guaranteed and intended only as informational. Exposing ceramic fasteners to the same forces typically exerted on metal fasteners is not recommended and may result in catastrophic failure.
- "Destructive Torque" is the average maximum torque on hex head bolts until failure.

CerMax™ High Temperature Non Conductive Ceramic Fasteners - Zirconia							
English (Other Sizes Available – Please Ask)				Metric (Other Sizes Available – Please Ask)			
Part Number	Type	Size	Price	Part Number	Type	Size	Price
FST-CZ-E-B-2-56x1/4	Bolt	2-56 x 1/4	\$ 50.98	FST-CZ-M-B-2X5	Bolt	2 mm x 5 mm	\$ 48.51
FST-CZ-E-B-4-40x1/4	Bolt	4-40 x 1/4	\$ 53.96	FST-CZ-M-B-2X10	Bolt	2 mm x 10 mm	\$ 49.83
FST-CZ-E-B-4-40x3/8	Bolt	4-40 x 3/8	\$ 55.28	FST-CZ-M-B-3X5	Bolt	3 mm x 5 mm	\$ 50.98
FST-CZ-E-B-4-40x1/2	Bolt	4-40 x 1/2	\$ 58.41	FST-CZ-M-B-3X10	Bolt	3 mm x 10 mm	\$ 53.30
FST-CZ-E-B-4-40x3/4	Bolt	4-40 x 3/4	\$ 64.19	FST-CZ-M-B-3X15	Bolt	3 mm x 15 mm	\$ 56.10
FST-CZ-E-B-4-40x1	Bolt	4-40 x 1	\$ 73.76	FST-CZ-M-B-3X20	Bolt	3 mm x 20 mm	\$ 61.55
FST-CZ-E-B-6-32x1/4	Bolt	6-32 x 1/4	\$ 60.22	FST-CZ-M-B-3X25	Bolt	3 mm x 25 mm	\$ 70.62
FST-CZ-E-B-6-32x3/8	Bolt	6-32 x 3/8	\$ 61.38	FST-CZ-M-B-4X5	Bolt	4 mm x 5 mm	\$ 56.93
FST-CZ-E-B-6-32x1/2	Bolt	6-32 x 1/2	\$ 65.34	FST-CZ-M-B-4X10	Bolt	4 mm x 10 mm	\$ 59.24
FST-CZ-E-B-6-32x3/4	Bolt	6-32 x 3/4	\$ 71.78	FST-CZ-M-B-4X15	Bolt	4 mm x 15 mm	\$ 62.87
FST-CZ-E-B-6-32x1	Bolt	6-32 x 1	\$ 80.52	FST-CZ-M-B-4X20	Bolt	4 mm x 20 mm	\$ 69.14
FST-CZ-E-B-8-32x1/4	Bolt	8-32 x 1/4	\$ 65.01	FST-CZ-M-B-4X25	Bolt	4 mm x 25 mm	\$ 78.54
FST-CZ-E-B-8-32x3/8	Bolt	8-32 x 3/8	\$ 67.32	FST-CZ-M-B-4X30	Bolt	4 mm x 30 mm	\$ 85.31
FST-CZ-E-B-8-32x1/2	Bolt	8-32 x 1/2	\$ 70.46	FST-CZ-M-B-5X5	Bolt	5 mm x 5 mm	\$ 64.19
FST-CZ-E-B-8-32x3/4	Bolt	8-32 x 3/4	\$ 77.39	FST-CZ-M-B-5X10	Bolt	5 mm x 10 mm	\$ 66.50
FST-CZ-E-B-8-32x1	Bolt	8-32 x 1	\$ 87.29	FST-CZ-M-B-5X15	Bolt	5 mm x 15 mm	\$ 70.62
FST-CZ-E-B-8-32x1-1/4	Bolt	8-32 x 1-1/4	\$ 93.39	FST-CZ-M-B-5X20	Bolt	5 mm x 20 mm	\$ 76.40
FST-CZ-E-B-10-32x1/4	Bolt	10-32 x 1/4	\$ 70.46	FST-CZ-M-B-5X25	Bolt	5 mm x 25 mm	\$ 86.13
FST-CZ-E-B-10-32x3/8	Bolt	10-32 x 3/8	\$ 73.26	FST-CZ-M-B-5X30	Bolt	5 mm x 30 mm	\$ 92.57
FST-CZ-E-B-10-32x1/2	Bolt	10-32 x 1/2	\$ 76.89	FST-CZ-M-B-5X40	Bolt	5 mm x 40 mm	\$ 102.96
FST-CZ-E-B-10-32x3/4	Bolt	10-32 x 3/4	\$ 84.65	FST-CZ-M-B-6X5	Bolt	6 mm x 5 mm	\$ 68.48
FST-CZ-E-B-10-32x1	Bolt	10-32 x 1	\$ 95.54	FST-CZ-M-B-6X10	Bolt	6 mm x 10 mm	\$ 71.45
FST-CZ-E-B-10-32x1-1/4	Bolt	10-32 x 1-1/4	\$ 101.97	FST-CZ-M-B-6X15	Bolt	6 mm x 15 mm	\$ 75.57
FST-CZ-E-B-10-32x1-1/2	Bolt	10-32 x 1-1/2	\$ 107.09	FST-CZ-M-B-6X20	Bolt	6 mm x 20 mm	\$ 82.34
FST-CZ-E-B-1/4-20x1/4	Bolt	1/4-20 x 1/4	\$ 74.25	FST-CZ-M-B-6X25	Bolt	6 mm x 25 mm	\$ 92.89
FST-CZ-E-B-1/4-20x3/8	Bolt	1/4-20 x 3/8	\$ 76.89	FST-CZ-M-B-6X30	Bolt	6 mm x 30 mm	\$ 99.83
FST-CZ-E-B-1/4-20x1/2	Bolt	1/4-20 x 1/2	\$ 81.02	FST-CZ-M-B-6X40	Bolt	6 mm x 40 mm	\$ 110.06
FST-CZ-E-B-1/4-20x3/4	Bolt	1/4-20 x 3/4	\$ 88.44	FST-CZ-M-B-6X50	Bolt	6 mm x 50 mm	\$ 120.12
FST-CZ-E-B-1/4-20x1	Bolt	1/4-20 x 1	\$ 101.48				
FST-CZ-E-B-1/4-20x1-1/4	Bolt	1/4-20 x 1-1/4	\$ 107.25				
FST-CZ-E-B-1/4-20x1-1/2	Bolt	1/4-20 x 1-1/2	\$ 112.37				
FST-CZ-E-B-1/4-20x1-3/4	Bolt	1/4-20 x 1-3/4	\$ 119.79				
FST-CZ-E-B-1/4-20x2	Bolt	1/4-20 x 2	\$ 126.23				

Material Properties – Alumina (A998) & Zirconia (TZP)

Property	Unit	A998	TZP
Physical Properties			
Composition (1)	weight %	99.8 AL ₂ O ₃	5.4 Y ₂ O ₃
Density (2)	g/cm ³	3.89	6.0
Porosity	volume %	Impervious	Impervious
Color		Ivory	Off-white
Mechanical Properties			
Hardness	GPa (knoop)	11.1	11.7
4-point Bend (3) Strength (MOR)	MPa (ksi)	325 (47)	600 (87)
Thermal Properties			
Maximum Service Temp	°C	1650	2200
Thermal Expansion Coefficient	°C ⁻¹ (25 – 700°C)	7.5 x 10 ⁻⁶	11.2 x 10 ⁻⁶
Thermal Conductivity (20°C)	W/m•°K (Btu•in/ft ² •hr•°F)	35 (242)	2 (14)
Electrical Properties			
Dielectric Strength	Volts/mil	200	51
Dielectric Constant	@1MHz @ 20°C	10.0	28.0
	Ohm.cm @ 25°C	14	>10 ¹³
Volume Resistivity	Ohm.cm @ 300°C	2.5x10 ¹¹	n/a
	Ohm.cm @ 500°C	5.5x10 ¹⁰	4.8x10 ³

1. Controlled by the Batch Composition

2. Measured by Pycnometer Immersion Technique

3. per ASTM C 1161-02c

Zirconia (Zirconium Oxide, ZrO₂)

Zirconia is one of the most studied ceramic materials. Zirconium dioxide (in its most naturally occurring form) is the mineral baddeleyite. Zirconia begins its life following a thermal treatment process (calcining) of the zirconium dioxide. This zirconia is further processed into different forms, including powder. Zirconia formulations utilize a "ready to press" type of zirconia powder for its near-net shaping manufacturing process.

Transformation Toughened

With a melting point of 2715°C and a boiling point of 4300°C, pure zirconia is extremely tough. However, when heated, phase changes in its physical characteristics reveal a weakness. In its tetragonal phase the expansion of a pure zirconia part results in internal stresses, leading to cracks. This inherent weakness is corrected with the addition of a stabilizer, such as yttria (Yttrium oxide, Y₂O₃), producing YTZP, a yttria partially stabilized zirconia.

A part made of YTZP zirconia remains stable as it moves from its monoclinic (room temperature) phase to its tetragonal (heated) phase and back again, resulting in lessened expansion, and minimal crack propagation. These changes are referred to as Transformation Toughening.

The common threads found making YTZP zirconia the material of choice often includes:

- Resistance to high abrasion
- Chemical stability
- Coefficient of thermal expansion similar to steel

Environments in which YTZP may not be suitable include long term water immersion and temperatures of 500° C (and above) in which electrical conductivity must be avoided. As with all custom ceramic part orders, we work closely with the customer to arrive at a ceramic formulation that not only meets the spec, but also avoids such undesirable circumstances.

Alumina (Aluminum Oxide, Al₂O₃)

Alumina, one of the oldest technical ceramics, remains one of the most common still in use. Alumina, thoroughly documented since the 1920's, is an industry standard to which many other ceramic materials are compared. Many of the custom ceramic parts Ceramco manufactures for its customers are made from alumina because of its desirable properties, including:

- Chemical inertness
- Resistance to high wear
- Resistance to thermal conductivity
- Resistance to electrical conductivity

Alumina's most notable characteristics are its high hardness, dielectric constant and high mechanical stability. These characteristics make alumina ideal for customer applications subject to high wear and/or low electric loss.

Stock Sizes Notes - alumina & zirconia (PSZ) fasteners

1. The pitch diameter of male threads will not exceed the max allowable according to Class 2. Minimum allowable pitch diameter may be below that of Class 2, conversely for female threads. Due to shrink factor variances, the stack up tolerance cannot be controlled on the pitch. It is recommended that you not engage more than 5 to 10 threads on any male fastener.

2. No warranty with respect to torque strength and tensile strength is extended or implied. Ceramic materials are inherently brittle and display catastrophic failure if impacted or stressed beyond material limits.

Head Styles:

- Socket Head
- Eye-bolt Head
- Hex Head
- Flat Head - Slotted, Phillips & Socket
- Pan Head - Slotted & Phillips

CerMax™ Dense Machinable Glass-Ceramic



- Machinable Dense Glass-Ceramics
- High Temperature & High Voltage use
- Readily Machined, no firing required
- Thermal Shock Resistance
- High Dielectric & Mechanical Strength

CerMax™ High Temperature Glass-Ceramic Machinable Forms

	MC-GC-P-L	MC-GC-P-H
Max Operating Temp	750°F / 400°C	1100°F / 593°C
Hardness	5.5	5.0
Specific Gravity g/cc	3.0	2.8
Density, lbs/in ²	.11	.10
Porosity, %	Nil	Nil
Thermal Expansion in/in/°F x 10 ⁻⁶	6.0 (10.8 for °C)	5.2 (9.5 for °C)
Compressive Strength, psi	45,000	32,000
Flexural Strength, psi	13,000	14,000
Dielectric Strength, v/mil	730	380
Loss Factor at 1 MHz	.009	.012
Dielectric Constant at 1 MHz	6.7	6.8
Thermal Conductivity, BTUx in/hrxft ² x°F (W/mx°K)	6.02 (.87)	4.08 (.59)

750°F/400°C Glass-Ceramic

Part Number	Type	Size (inches)	Price
MC-GC-P-L-1/4-4-6	Plate	¼ x 4 x 6	\$ 150.00
MC-GC-P-L-1/4-14-20	Plate	¼ x 14 x 20	\$ 760.00
MC-GC-P-L-3/8-4-6	Plate	3/8 x 4 x 6	\$ 170.00
MC-GC-P-L-3/8-14-20	Plate	3/8 x 14 x 20	\$ 840.00
MC-GC-P-L-1/2-4-6	Plate	½ x 4 x 6	\$ 200.00
MC-GC-P-L -1/2-14-20	Plate	½ x 14 x 20	\$ 970.00
MC-GC-P-L -3/4-4-6	Plate	¾ x 4 x 6	\$ 250.00
MC-GC-P-L -3/4-14-20	Plate	¾ x 14 x 20	\$ 1260.00
MC-GC-P-L -1-4-6	Plate	1 x 4 x 6	\$ 320.00
MC-GC-P-L -1-14-20	Plate	1 x 14 x 20	\$ 1590.00
MC-GC-R-L -1/4-12	Rod	¼ x 12	\$ 170.00
MC-GC-R-L -1/2-12	Rod	½ x 12	\$ 200.00
MC-GC-R-L -3/4-12	Rod	¾ x 12	\$ 260.00
MC-GC-R-L -1-12	Rod	1 x 12	\$ 330.00

1100°F / 593°C Glass-Ceramic

Part Number	Type	Size (inches)	Price
MC-GC-P-H-1/4-4-6	Plate	¼ x 4 x 6	\$ 220.00
MC-GC-P-H-1/4-14-20	Plate	¼ x 14 x 20	\$ 1560.00
MC-GC-P-H-3/8-4-6	Plate	3/8 x 4 x 6	\$ 244.00
MC-GC-P-H-3/8-14-20	Plate	3/8 x 14 x 20	\$1730.00
MC-GC-P-H-1/2-4-6	Plate	½ x 4 x 6	\$ 274.00
MC-GC-P-H -1/2-14-20	Plate	½ x 14 x 20	\$ 1940.00
MC-GC-P-H -3/4-4-6	Plate	¾ x 4 x 6	\$ 396.00
MC-GC-P-H -3/4-14-20	Plate	¾ x 14 x 20	\$ 2810.00
MC-GC-P-H -1-4-6	Plate	1 x 4 x 6	\$ 588.00
MC-GC-P-H -1-14-20	Plate	1 x 14 x 20	\$ 4170.00
MC-GC-R-H -1/4-12	Rod	¼ x 12	\$ 200.00
MC-GC-R-H -1/2-12	Rod	½ x 12	\$ 260.00
MC-GC-R-H -3/4-12	Rod	¾ x 12	\$ 290.00
MC-GC-R-H -1-12	Rod	1 x 12	\$ 600.00

CerMax™ Dense Machinable Unfired Aluminum Silicate



- Machinable Dense Glass-Ceramics
- High Temperature & High Voltage use
- Readily Machined, no firing required
- Thermal Shock Resistance
- High Dielectric & Mechanical Strength

CerMax™ High Temperature Glass-Ceramic Machinable Forms

	MC-GC-P-L	MC-GC-P-H
Max Operating Temp	750°F / 400°C	1100°F / 593°C
Hardness	5.5	5.0
Specific Gravity g/cc	3.0	2.8
Density, lbs/in ²	.11	.10
Porosity, %	Nil	Nil
Thermal Expansion in/in/°F x 10 ⁻⁶	6.0 (10.8 for °C)	5.2 (9.5 for °C)
Compressive Strength, psi	45,000	32,000
Flexural Strength, psi	13,000	14,000
Dielectric Strength, v/mil	730	380
Loss Factor at 1 MHz	.009	.012
Dielectric Constant at 1 MHz	6.7	6.8
Thermal Conductivity, BTUx in/hrxft ² x°F (W/mx°K)	6.02 (.87)	4.08 (.59)

750°F/400°C Glass-Ceramic

Part Number	Type	Size (inches)	Price
MC-GC-P-L-1/4-4-6	Plate	¼ x 4 x 6	\$ 150.00
MC-GC-P-L-1/4-14-20	Plate	¼ x 14 x 20	\$ 760.00
MC-GC-P-L-3/8-4-6	Plate	3/8 x 4 x 6	\$ 170.00
MC-GC-P-L-3/8-14-20	Plate	3/8 x 14 x 20	\$ 840.00
MC-GC-P-L-1/2-4-6	Plate	½ x 4 x 6	\$ 200.00
MC-GC-P-L-1/2-14-20	Plate	½ x 14 x 20	\$ 970.00
MC-GC-P-L-3/4-4-6	Plate	¾ x 4 x 6	\$ 250.00
MC-GC-P-L-3/4-14-20	Plate	¾ x 14 x 20	\$ 1260.00
MC-GC-P-L-1-4-6	Plate	1 x 4 x 6	\$ 320.00
MC-GC-P-L-1-14-20	Plate	1 x 14 x 20	\$ 1590.00
MC-GC-R-L-1/4-12	Rod	¼ x 12	\$ 170.00
MC-GC-R-L-1/2-12	Rod	½ x 12	\$ 200.00
MC-GC-R-L-3/4-12	Rod	¾ x 12	\$ 260.00
MC-GC-R-L-1-12	Rod	1 x 12	\$ 330.00

CerMax™ High Temperature Round Flat Bottom Crucibles



- Alumina & Magnesium Oxide Crucibles
- Full Fired
- Inert to Molten Metals & Slags
- Thermal Shock Resistance
- High Dielectric & Mechanical Strength

CerMax™ Round Crucibles – Magnesium Oxide / Alumina		
	Magnesium Oxide	Alumina
Max Operating Temp	3270°F / 1800°C	3000°F / 1649°C
Hardness	5.5	9.0
Specific Gravity g/cc	3.45	3.9
Density, lbs/in ²	.12	.134
Porosity, %	4.5	Nil
Thermal Expansion in/in/°F x 10 ⁻⁶	7.7 (13.9 for °C)	3.5 (6.3 for °C)
Compressive Strength, psi	120,000	340,000
Flexural Strength, psi	35,000	46,000
Dielectric Strength, v/mil	150	225
Loss Factor at 1 MHz	-	.0018
Dielectric Constant at 1 MHz	9.6	9.3
Thermal Conductivity, BTUx in/hrxft ² x°F (W/mx°K)	15.0 (2.2)	220 (31.7)

Round Flat Bottom Crucibles

For "X" in the part number: use "M" for Magnesium Oxide
use "A" for Alumina

Part Number	OD		Length		Price
CC-FB-X-10010	1.00	25.40	1.00	25.40	\$ 68.00
CC-FB-X-10012	1.00	25.40	1.25	31.75	\$ 74.00
CC-FB-X-12512	1.25	31.75	1.25	31.75	\$ 92.00
CC-FB-X-12525	1.25	31.75	2.50	63.50	\$ 130.00
CC-FB-X-15020	1.50	38.10	2.00	50.80	\$ 132.00
CC-FB-X-15030	1.50	38.10	3.00	76.20	\$ 166.00
CC-FB-X-17525	1.75	44.45	2.50	63.50	\$ 168.00
CC-FB-X-17535	1.75	44.45	3.50	88.90	\$ 206.00
CC-FB-X-20020	2.00	50.80	2.00	50.80	\$ 166.00
CC-FB-X-20035	2.00	50.80	3.50	88.90	\$ 230.00
CC-FB-X-20050	2.00	50.80	5.00	127.00	\$ 290.00
CC-FB-X-20060	2.00	50.80	6.00	152.40	\$ 328.00
CC-FB-X-22535	2.25	57.15	3.50	88.90	\$ 254.00
CC-FB-X-25030	2.50	63.50	3.00	76.20	\$ 252.00
CC-FB-X-25055	2.50	63.50	5.50	139.70	\$ 372.00
CC-FB-X-30030	3.00	76.20	3.00	76.20	\$ 330.00
CC-FB-X-30040	3.00	76.20	4.00	101.60	\$ 394.00
CC-FB-X-30045	3.00	76.20	4.50	114.30	\$ 426.00
CC-FB-X-30057	3.00	76.20	5.75	146.05	\$ 502.00
CC-FB-X-35050	3.50	88.90	5.00	127.00	\$ 526.00
CC-FB-X-35060	3.50	88.90	6.00	152.40	\$ 594.00
CC-FB-X-40040	4.00	101.60	4.00	101.60	\$ 514.00
CC-FB-X-40060	4.00	101.60	6.00	152.40	\$ 670.00
CC-FB-X-45045	4.50	114.30	4.50	114.30	\$ 620.00
CC-FB-X-45060	4.50	114.30	6.00	152.40	\$ 746.00
CC-FB-X-50050	5.00	127.00	5.00	127.00	\$ 732.00
CC-FB-X-50080	5.00	127.00	8.00	203.20	\$ 1000.00
CC-FB-X-55055	5.50	139.70	5.50	139.70	\$ 852.00
CC-FB-X-60060	6.00	152.40	6.00	152.40	\$ 1084.00
CC-FB-X-600X0	6.00	152.40	10.00	254.00	\$ 1530.00

High Temperature, Heat, Flame, Fire, Molten Metal & Weld Splatter Protection Materials

Fax Orders: 610-340-9054 Telephone Orders: 610-906-3549 orders@abthermal.com

Silicone Rubber Products

Silicone Rubber Tubing, Industrial Grade – Oxide-Red	9-1
Silicone Rubber Tubing, Industrial Grade – Natural / Clear	9-2
Silicone Rubber Tubing, Industrial Grade – Large Diameter	9-3
Silicone Rubber Tubing, FDA Food/Medical Grade; small diameter	9-4
Silicone Rubber Tubing, FDA Food/Medical Grade; large diameter	9-5
Silicone Rubber Caps and Plugs	9-6
Silicone Rubber Adhesives, Sealants, End-Seal Dip, Paint, Ink	9-11
Silicone Rubber Extruded Profiles	9-12
Silicone Rubber Electrical Strip Heaters	9-13
Sil-Ink™ High Temperature Ink for Printing on Silicone Rubber (Primary) – EPDM, EPR (Secondary)	9-14



Silicone Rubber Tubing
Page 9-1 – 9-5



Silicone Rubber Plugs
Page 9-6 – 9-10



Silicone End-Seal Dip,
Paint & Ink
Page 9-11



Silicone Adhesive/Sealant
Page 9-11

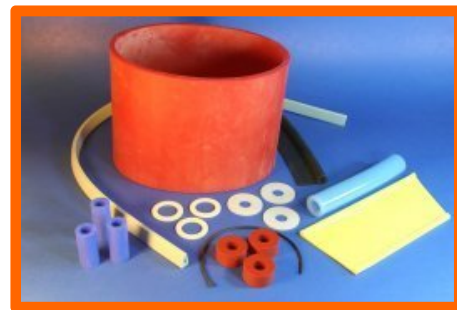

Silicone Rubber Extruded
Profile Shapes Page 9-12



Silicone Rubber Extruded
Gasket & Seal Shapes
Page 9-12



Silicone Flexible Strip
Heaters Page 9-13

Silicone Rubber Tubing; High Temperature & Heat Resistant 460°F / 237°C: Premium Grade – Oxide-Red Color



Variety of uses including air, gas and liquid transfer.

Can be used to mask threads and posts for powder coating painting applications.

Good elasticity to fit over pipe nipples.

Weld splatter, grinding spark and molten metal splash protection.

Hardness: 50 +/-5, Tensile: >1000 psi,
Elongation: >400%, Tear Strength: >100 lbs/in,
Specific Gravity: <1.7, Electrical Resistance: 24kV/mm,
Electrical Volume Resistivity: 1 x 10 ohm/cm

High Temperature, Heat & Flame Resistant Silicone Rubber Tubing Premium Grade – Oxide-Red Color				
Part Number	Inside Diameter in / mm	Wall Thickness in / mm	Coiled Length ft / m	Price per Coil
SR-TUBE-RED-ID104-W04-10	.104 / 2.60	.040 / 1.00	100 / 30.48	\$ 152.67
SR-TUBE-RED-ID110-W04-10	.110 / 2.80	.040 / 1.00	100 / 30.48	\$ 156.70
SR-TUBE-RED-ID130-W04-10	.130 / 3.30	.040 / 1.00	100 / 30.48	\$ 161.00
SR-TUBE-RED-ID149-W04-10	.149 / 3.80	.040 / 1.00	100 / 30.48	\$ 164.33
SR-TUBE-RED-ID163-W04-10	.163 / 4.10	.040 / 1.00	100 / 30.48	\$ 171.67
SR-TUBE-RED-ID181-W04-10	.181 / 4.60	.040 / 1.00	100 / 30.48	\$ 183.67
SR-TUBE-RED-ID224-W04-10	.224 / 5.70	.040 / 1.00	100 / 30.48	\$ 194.67
SR-TUBE-RED-ID239-W04-10	.239 / 6.10	.040 / 1.00	100 / 30.48	\$ 202.00
SR-TUBE-RED-ID302-W06-15	.302 / 7.70	.060 / 1.50	100 / 30.48	\$ 229.00
SR-TUBE-RED-ID330-W06-15	.330 / 8.40	.060 / 1.50	100 / 30.48	\$ 240.33
SR-TUBE-RED-ID363-W06-15	.363 / 9.20	.060 / 1.50	100 / 30.48	\$ 244.33
SR-TUBE-RED-ID375-W06-15	.375 / 9.53	.060 / 1.50	100 / 30.48	\$ 249.69
SR-TUBE-RED-ID380-W06-15	.380 / 9.70	.060 / 1.50	100 / 30.48	\$ 252.13
SR-TUBE-RED-ID406-W06-15	.406 / 10.31	.060 / 1.50	100 / 30.48	\$ 260.48
SR-TUBE-RED-ID420-W06-15	.420 / 10.60	.060 / 1.50	100 / 30.48	\$ 266.67
SR-TUBE-RED-ID437-W06-15	.437 / 11.10	.060 / 1.50	100 / 30.48	\$ 278.83
SR-TUBE-RED-ID460-W06-15	.460 / 11.70	.060 / 1.50	100 / 30.48	\$ 282.33
SR-TUBE-RED-ID485-W06-15	.485 / 12.30	.060 / 1.50	50 / 15.24	\$ 143.67
SR-TUBE-RED-ID500-W06-15	.500 / 12.70	.060 / 1.50	50 / 15.24	\$ 166.91
SR-TUBE-RED-ID535-W06-15	.535 / 13.60	.060 / 1.50	50 / 15.24	\$ 183.67
SR-TUBE-RED-ID609-W06-15	.609 / 15.50	.060 / 1.50	50 / 15.24	\$ 207.03
SR-TUBE-RED-ID625-W06-15	.625 / 15.88	.060 / 1.50	50 / 15.24	\$ 222.62
SR-TUBE-RED-ID727-W06-15	.727 / 18.50	.060 / 1.50	50 / 15.24	\$ 236.67
SR-TUBE-RED-ID750-W06-15	.750 / 19.05	.060 / 1.50	50 / 15.24	\$ 281.48
SR-TUBE-RED-ID853-W06-15	.853 / 21.67	.060 / 1.50	50 / 15.24	\$ 366.67
SR-TUBE-RED-ID875-W06-15	.875 / 22.23	.060 / 1.50	50 / 15.24	\$ 373.81
SR-TUBE-RED-ID915-W06-15	.915 / 23.34	.060 / 1.50	50 / 15.24	\$ 381.33
SR-TUBE-RED-ID937-W06-15	.937 / 23.80	.060 / 1.50	50 / 15.24	\$ 390.64
SR-TUBE-RED-ID975-W06-15	.975 / 24.77	.060 / 1.50	50 / 15.24	\$ 400.35

This Product is NOT Available By-The-Foot – Full Coil Quantity Only

These silicone rubber products provide excellent cold temperature performance with flexibility to -76°C for refrigeration and cryogenic applications.

Silicone Rubber Tubing; High Temperature & Heat Resistant 500°F / 260°C: Premium Grade – Natural / Translucent



Variety of uses including air, gas and liquid transfer.

Can be used to mask threads and posts for powder coating painting applications.

Good elasticity to fit over pipe nipples.

Hardness: 50 +/-5, Tensile: >1000 psi,
Elongation: >400%, Tear Strength: >100 lbs/in,
Specific Gravity: <1.7, Electrical Resistance: 24kV/mm,
Electrical Volume Resistivity: 1 x 10 ohm/cm

500°F / 260°C continuous rating

High Temperature, Heat & Flame Resistant Silicone Rubber Tubing Premium Natural / Clear				
Part Number	Inside Diameter in / mm	Wall Thickness in / mm	Coiled Length ft / m	Price per Coil
SR-TUBE-NAT-ID040-W06-15	.040 / 1.02	.060 / 1.50	100 / 30.48	\$ 74.20
SR-TUBE-NAT-ID062-W06-15	.062 / 1.57	.060 / 1.50	100 / 30.48	\$ 78.64
SR-TUBE-NAT-ID080-W06-15	.080 / 2.03	.060 / 1.50	100 / 30.48	\$ 81.80
SR-TUBE-NAT-ID093-W06-15	.093 / 2.36	.060 / 1.50	100 / 30.48	\$ 85.63
SR-TUBE-NAT-ID109-W06-15	.109 / 2.77	.060 / 1.50	100 / 30.48	\$ 107.81
SR-TUBE-NAT-ID125-W06-15	.125 / 3.18	.060 / 1.50	100 / 30.48	\$ 111.26
SR-TUBE-NAT-ID140-W06-15	.140 / 3.56	.060 / 1.50	100 / 30.48	\$ 115.10
SR-TUBE-NAT-ID156-W06-15	.156 / 3.96	.060 / 1.50	100 / 30.48	\$ 118.36
SR-TUBE-NAT-ID172-W06-15	.172 / 4.37	.060 / 1.50	100 / 30.48	\$ 122.73
SR-TUBE-NAT-ID187-W06-15	.187 / 4.75	.060 / 1.50	100 / 30.48	\$ 131.67
SR-TUBE-NAT-ID203-W06-15	.203 / 5.16	.060 / 1.50	100 / 30.48	\$ 137.17
SR-TUBE-NAT-ID218-W06-15	.218 / 5.54	.060 / 1.50	100 / 30.48	\$ 144.90
SR-TUBE-NAT-ID234-W06-15	.234 / 5.94	.060 / 1.50	100 / 30.48	\$ 152.32
SR-TUBE-NAT-ID250-W06-15	.250 / 6.35	.060 / 1.50	100 / 30.48	\$ 159.80
SR-TUBE-NAT-ID281-W06-15	.281 / 7.14	.060 / 1.50	100 / 30.48	\$ 174.67
SR-TUBE-NAT-ID312-W06-15	.312 / 7.92	.060 / 1.50	100 / 30.48	\$ 189.22

This Product is NOT Available By-The-Foot – Full Coil Quantity Only

These silicone rubber products provide excellent cold temperature performance with flexibility to -76°C for refrigeration and cryogenic applications.

**Silicone Rubber Tubing; High Temperature & Heat Resistant
 500°F / 260°C: Premium Grade – Oxide-Red Color – Large Diameter**



Variety of uses including air, gas and liquid transfer.

Can be used to mask threads and posts for powder coating.

Good elasticity to fit over pipe nipples.

Hardness: 50 +/-5, Tensile: >1000 psi,
 Elongation: >400%, Tear Strength: >100 lbs/in,
 Specific Gravity: <1.7, Electrical Resistance: 24kV/mm,
 Electrical Volume Resistivity: 1 x 10 ohm/cm

500°F / 260°C continuous rating

High Temperature, Heat & Flame Resistant Silicone Rubber Tubing Industrial – Oxide-Red Color – Large Diameter				
Part Number	Inside Diameter in / mm	Wall Thickness in / mm	Coiled Length ft / m	Price per Coil
SR-TUBEXL-RED-1000-W06-15	1.000 / 25.40	.060 / 1.50	100 / 30.48	\$ 347.87
SR-TUBEXL-RED-1125-W06-15	1.125 / 28.58	.060 / 1.50	100 / 30.48	\$ 375.71
SR-TUBEXL-RED-1250-W06-15	1.250 / 31.75	.060 / 1.50	100 / 30.48	\$ 417.33
SR-TUBEXL-RED-1375-W06-15	1.375 / 34.93	.060 / 1.50	100 / 30.48	\$ 486.97
SR-TUBEXL-RED-1500-W06-15	1.500 / 38.10	.060 / 1.50	100 / 30.48	\$ 556.40
SR-TUBEXL-RED-1625-W06-15	1.625 / 41.28	.060 / 1.50	100 / 30.48	\$ 584.67
SR-TUBEXL-RED-1750-W06-15	1.750 / 44.45	.060 / 1.50	100 / 30.48	\$ 626.11
SR-TUBEXL-RED-1875-W06-15	1.875 / 47.63	.060 / 1.50	100 / 30.48	\$ 751.15
SR-TUBEXL-RED-2000-W06-15	2.000 / 50.80	.060 / 1.50	100 / 30.48	\$ 797.47

This Product is NOT Available By-The-Foot – Full Coil Quantity Only

These silicone rubber products provide excellent cold temperature performance with flexibility to -76°C for refrigeration and cryogenic applications.

Silicone Rubber Tubing: Food & Medical Grade High Temperature & Heat Resistant: Premium Grade - ID 1/32" to 5/16"



Custom extruded - delivery may be up to 4 weeks.
Available in Natural translucent or red.

Conforms to FDA 21 CFR 177-2600.

Meets A-A-59588 (MIL-ZZ-R-765E Class 2A, Grade 50).
Meets SAE-AMS-3302.

Meets ASTM D2000
M5GE506A19B37EA14E016E036F19G11

Tolerance is to ISO 3302-1 Class E2.

400°F / 204°C continuous rating with weld splatter, spark, molten metal splash protection
450°F / 232°C intermittent. Short use to 480°F / 250°C. Cold use to -60°F / -50°C

High Temperature, Heat & Flame Resistant Silicone Rubber Tubing				
Part Number	Inside Diameter frac / in / mm	Wall Thickness frac / in / mm	Coiled Length ft / m	Price per Coil
SR-PGT-ID031-W031-X	1/32 / .031 / 0.8	1/32 / .031 / 0.8	100 / 30.48	\$ Call
SR-PGT-ID063-W031-X	1/16 / .063 / 1.60	1/32 / .031 / 0.8	100 / 30.48	\$ Call
SR-PGT-ID063-W063-X	1/16 / .063 / 1.60	1/16 / .063 / 1.6	100 / 30.48	\$ Call
SR-PGT-ID094-W031-X	3/32 / .094 / 2.40	1/32 / .031 / 0.8	100 / 30.48	\$ Call
SR-PGT-ID094-W063-X	3/32 / .094 / 2.40	1/16 / .063 / 1.6	100 / 30.48	\$ Call
SR-PGT-ID125-W031-X	1/8 / .125 / 3.20	1/32 / .031 / 0.8	100 / 30.48	\$ Call
SR-PGT-ID125-W063-X	1/8 / .125 / 3.20	1/16 / .063 / 1.6	100 / 30.48	\$ Call
SR-PGT-ID125-W094-X	1/8 / .125 / 3.20	3/32 / .094 / 2.40	100 / 30.48	\$ Call
SR-PGT-ID125-W125-X	1/8 / .125 / 3.20	1/8 / .125 / 3.20	100 / 30.48	\$ Call
SR-PGT-ID188-W031-X	3/16 / .188 / 4.8	1/32 / .031 / 0.8	100 / 30.48	\$ Call
SR-PGT-ID188-W063-X	3/16 / .188 / 4.8	1/16 / .063 / 1.6	100 / 30.48	\$ Call
SR-PGT-ID188-W094-X	3/16 / .188 / 4.8	3/32 / .094 / 2.40	100 / 30.48	\$ Call
SR-PGT-ID188-W125-X	3/16 / .188 / 4.8	1/8 / .125 / 3.20	100 / 30.48	\$ Call
SR-PGT-ID188-W188-X	3/16 / .188 / 4.8	3/16 / .188 / 4.80	100 / 30.48	\$ Call
SR-PGT-ID250-W031-X	1/4 / .250 / 6.4	1/32 / .031 / 0.8	100 / 30.48	\$ Call
SR-PGT-ID250-W063-X	1/4 / .250 / 6.4	1/16 / .063 / 1.6	100 / 30.48	\$ Call
SR-PGT-ID250-W094-X	1/4 / .250 / 6.4	3/32 / .094 / 2.40	100 / 30.48	\$ Call
SR-PGT-ID250-W125-X	1/4 / .250 / 6.4	1/8 / .125 / 3.20	100 / 30.48	\$ Call
SR-PGT-ID313-W031-X	5/16 / .313 / 8.0	1/32 / .031 / 0.8	100 / 30.48	\$ Call
SR-PGT-ID313-W063-X	5/16 / .313 / 8.0	1/16 / .063 / 1.6	100 / 30.48	\$ Call
SR-PGT-ID313-W094-X	5/16 / .313 / 8.0	3/32 / .094 / 2.40	100 / 30.48	\$ Call
SR-PGT-ID313-W125-X	5/16 / .313 / 8.0	1/8 / .125 / 3.20	100 / 30.48	\$ Call

Minimum Order Quantity is 200 Feet

This Product is NOT Available By-The-Foot – Full Coil Quantity Only

For the "X" value, Use "N" for natural and "R" for oxide-red

Silicone Rubber Tubing: Food & Medical Grade High Temperature & Heat Resistant: Premium Grade - ID 3/8" to 1"



Custom extruded - delivery may be up to 4 weeks.
Available in Natural translucent or red.

Conforms to FDA 21 CFR 177-2600.

Meets A-A-59588 (MIL-ZZ-R-765E Class 2A, Grade 50).
Meets SAE-AMS-3302.

Meets ASTM D2000
M5GE506A19B37EA14E016E036F19G11

Tolerance is to ISO 3302-1 Class E2.

400°F / 204°C continuous rating with weld splatter, spark, molten metal splash protection
450°F / 232°C intermittent. Short use to 480°F / 250°C. Cold use to -60°F / -50°C

High Temperature, Heat & Flame Resistant Silicone Rubber Tubing				
Part Number	Inside Diameter frac / in / mm	Wall Thickness frac / in / mm	Coiled Length ft / m	Price per Coil
SR-PGT-ID375-W031-X	3/8 / .375 / 9.50	1/32 / .031 / 0.8	100 / 30.48	\$ Call
SR-PGT-ID375-W063-X	3/8 / .375 / 9.50	1/16 / .063 / 1.6	100 / 30.48	\$ Call
SR-PGT-ID375-W094-X	3/8 / .375 / 9.50	3/32 / .094 / 2.40	100 / 30.48	\$ Call
SR-PGT-ID375-W125-X	3/8 / .375 / 9.50	1/8 / .125 / 3.20	100 / 30.48	\$ Call
SR-PGT-ID375-W188-X	3/8 / .375 / 9.50	3/16 / .188 / 4.80	100 / 30.48	\$ Call
SR-PGT-ID438-W031-X	7/16 / .438 / 11.1	1/32 / .031 / 0.8	100 / 30.48	\$ Call
SR-PGT-ID438-W094-X	7/16 / .438 / 11.1	3/32 / .094 / 2.40	100 / 30.48	\$ Call
SR-PGT-ID500-W031-X	1/2 / .500 / 12.7	1/32 / .031 / 0.8	100 / 30.48	\$ Call
SR-PGT-ID500-W063-X	1/2 / .500 / 12.7	1/16 / .063 / 1.6	100 / 30.48	\$ Call
SR-PGT-ID500-W094-X	1/2 / .500 / 12.7	3/32 / .094 / 2.40	50 / 15.24	\$ Call
SR-PGT-ID500-W125-X	1/2 / .500 / 12.7	1/8 / .125 / 3.20	50 / 15.24	\$ Call
SR-PGT-ID500-W188-X	1/2 / .500 / 12.7	3/16 / .188 / 4.80	50 / 15.24	\$ Call
SR-PGT-ID625-W063-X	5/8 / .625 / 15.9	1/16 / .063 / 1.6	50 / 15.24	\$ Call
SR-PGT-ID625-W094-X	5/8 / .625 / 15.9	3/32 / .094 / 2.40	50 / 15.24	\$ Call
SR-PGT-ID625-W125-X	5/8 / .625 / 15.9	1/8 / .125 / 3.20	50 / 15.24	\$ Call
SR-PGT-ID625-W188-X	5/8 / .625 / 15.9	3/16 / .188 / 4.80	50 / 15.24	\$ Call
SR-PGT-ID750-W063-X	3/4 / .750 / 19.1	1/16 / .063 / 1.6	50 / 15.24	\$ Call
SR-PGT-ID750-W125-X	3/4 / .750 / 19.1	1/8 / .125 / 3.20	50 / 15.24	\$ Call
SR-PGT-ID750-W188-X	3/4 / .750 / 19.1	3/16 / .188 / 4.80	50 / 15.24	\$ Call
SR-PGT-ID1000-W031-X	1 / 1.000 / 25.4	1/32 / .031 / 0.8	50 / 15.24	\$ Call
SR-PGT-ID1000-W063-X	1 / 1.000 / 25.4	1/16 / .063 / 1.6	50 / 15.24	\$ Call
SR-PGT-ID1000-W125-X	1 / 1.000 / 25.4	1/8 / .125 / 3.20	50 / 15.24	\$ Call

Minimum Order Quantity is full coil

This Product is NOT Available By-The-Foot – Full Coil Quantity Only

For the "X" value (color code), Use "N" for natural or "R" for oxide-red

Silicone Rubber Star Tubing
High Temperature & Heat Resistant Suited for Powder Coating
500°F / 260°C: Premium Grade



- Star shaped tubing is easier to install and remove on studs and rods than round tubing as it has less contact area.
- Sizing assignment is easy to repeat without measuring due to unique colors for most sizes.
- Excellent elasticity.
- Can be used to mask threads and posts for powder coating.
- .062" wall thickness.

High Temperature, Heat & Flame Resistant Silicone Rubber Star Tubing				
Part Number	Minor ID in / mm	Major ID in / mm	Coiled Length ft / m	Price per Coil
SR-STAR-0.200-WHITE	0.200 / 5.0	.250 / 6.3	100 / 30	\$ 192.00
SR-STAR-0.300-RUST	0.300 / 7.6	.375 / 9.5	100 / 30	\$ 216.00
SR-STAR-0.400-YELLOW	0.400 / 10.2	.500 / 12.7	100 / 30	\$ 285.00
SR-STAR-0.500-PURPLE	0.500 / 12.7	.625 / 15.9	100 / 30	\$ 381.00
SR-STAR-0.625-RUST	0.625 / 15.9	.750 / 19.0	50 / 15	\$ 237.00
SR-STAR-0.725-BLUE	0.725 / 18.4	.875 / 22.2	50 / 15	\$ 285.00
SR-STAR-0.850-WHITE	0.850 / 21.6	1.000 / 25.4	50 / 15	\$ 342.00
SR-STAR-1.000-CLEAR	1.000 / 25.4	1.250 / 31.7	25 / 7.6	\$ 228.75
SR-STAR-1.250-PURPLE	1.250 / 31.7	1.500 / 38.1	25 / 7.6	\$ 262.50
SR-STAR-1.500-RUST	1.500 / 38.1	1.750 / 44.4	25 / 7.6	\$ 285.00
SR-STAR-1.750-ORANGE	1.750 / 44.4	2.000 / 50.8	25 / 7.6	\$ 309.75

This Product is NOT Available By-The-Foot – Full Coil Quantity Only

These silicone rubber products provide excellent cold temperature performance with flexibility to -76°C for refrigeration and cryogenic applications.

Silicone Rubber Tapered Plugs: High Temperature & Heat Resistant Small Sizes



- High Temperature natural color Silicone Rubber for use at 500°F / 260°C continuous and up to 600°F / 316°C intermittent short duration.
- Some sizes also available in EPDM (black) with a lower temperature range (425°F / 218°C).

High Temperature & Heat Resistant Silicone Rubber Tapered Plugs Small Size: 1.6mm x .4mm x 15.9mm to 12.7mm x 7.9mm x 25.4mm (Above dimension is Wide End x Small End x Length)						
Part Number	Large End Diameter in / mm	Small End Diameter in / mm	Length in / mm	Pack Quantity	Color	Price
SR-TP-1.6-0.4-15.9	.062 / 1.6	.016 / 0.4	.625 / 15.9	1000		\$ 62.20
SR-TP-2.0-0.5-19.1	.078 / 2.0	.020 / 0.5	.750 / 19.1	1000		\$ 70.67
SR-TP-2.03-.38-50.8-E	.080 / 2.03	.015 / 0.38	2.000 / 50.80	500	W	\$ 84.00
SR-TP-3.2-0.8-15.9	.125 / 3.2	.031 / 0.8	.625 / 15.9	1000		\$ 57.97
SR-TP-3.2-1.6-15.9	.125 / 3.2	.062 / 1.6	.625 / 15.9	1000		\$ 49.75
SR-TP-4.7-1.6-15.9	.187 / 4.7	.062 / 1.6	.625 / 15.9	1000		\$ 59.38
SR-TP-4.7-1.6-19.1-M*	.187 / 4.7	.062 / 1.6	.750 / 19.1	1000	OR	\$ 66.42
SR-TP-5.0-1.2-27.9	.197 / 5.0	.049 / 1.2	1.100 / 27.9	1000		\$ 85.53
SR-TP-5.1-1.6-19.1	.200 / 5.1	.062 / 1.6	0.750 / 19.1	1000		\$ 73.53
SR-TP-6.3-3.2-19.1	.250 / 6.3	.125 / 3.2	0.750 / 19.1	1000		\$ 86.23
SR-TP-6.3-3.2-25.4-M*	.250 / 6.3	.125 / 3.2	1.000 / 25.4	1000	OR	\$ 106.05
SR-TP-7.1-0.4-25.0	.279 / 7.1	.016 / 0.4	0.984 / 25.0	1000		\$ 275.67
SR-TP-8.7-4.7-15.9	.343 / 8.7	.187 / 4.7	0.625 / 15.9	1000		\$ 108.85
SR-TP-8.7-4.7-25.4-M*	.343 / 8.7	.187 / 4.7	1.000 / 25.4	1000	OR	\$ 141.37
SR-TP-9.5-3.2-31.8	.375 / 9.5	.125 / 3.2	1.250 / 31.8	1000		\$ 127.22
SR-TP-9.5-6.3-19.1	.375 / 9.5	.250 / 6.3	0.750 / 19.1	1000		\$ 175.30
SR-TP-11.1-6.3-25.4-M*	.437 / 11.1	.250 / 6.3	1.000 / 25.4	1000	OR	\$ 226.20
SR-TP-12.0-9.0-18.0	.472 / 12.0	.354 / 9.0	0.708 / 18.0	500		\$ 152.63
SR-TP-12.7-3.2-50.8	.500 / 12.7	.125 / 3.2	2.000 / 50.8	500		\$ 182.27
SR-TP-12.7-7.9-25.4	.500 / 12.7	.312 / 7.9	1.000 / 25.4	200		\$ 66.73
SR-TP-14.27-7.95-28.58-M*	.562 / 14.27	.313 / 7.95	1.125 / 28.58	250	OR	
SR-TP-13.67-7.1-25	.538 / 13.67	.279 / 7.14	.984 / 25.0	500		\$ 263.63
SR-TP-15.0-10.0-25.4	.590 / 15.0	.393 / 10.0	1.000 / 25.4	100		\$ 41.00
SR-TP-15.9-11.1-20.7	.625 / 15.9	.437 / 11.1	.813 / 20.7	200		\$ 84.83
SR-TP-17.0-13.0-25.4	.669 / 17.0	.510 / 13.0	1.000 / 25.4	200		\$ 104.60

* For the same size plug in EPDM rubber, subtract 10% from pricing.
Change the prefix from "SR-TP" to "EP-TP"

Silicone Rubber Tapered Plugs: High Temperature & Heat Resistant Large Sizes



- High Temperature natural color Silicone Rubber for use at 500°F / 260°C continuous and up to 600°F / 316°C intermittent short duration.
- Also available in EPDM (black) with a lower temperature range (425°F / 218°C).

High Temperature, Heat & Flame Resistant Silicone Rubber Tapered Plugs Small Size: 13.67mm x 7.1mm x 25mm to 127mm x 90mm x 50mm

Part Number	Large End Diameter in / mm	Small End Diameter in / mm	Length in / mm	Pack Size	Price
SR-TP-19.0-14.0-25.4	.748 / 19.0	.550 / 14.0	1.000 / 25.4	100	\$ 113.65
SR-TP-20.0-16.0-25.4	.787 / 20.0	.630 / 16.0	1.000 / 25.4	100	\$ 79.65
SR-TP-20.24-13.7-25.0	.797 / 20.24	.538 / 13.7	.984 / 25.0	200	\$ 257.30
SR-TP-23.8-18.0-25.4	.938 / 23.8	.708 / 18.0	1.000 / 25.4	100	\$ 87.08
SR-TP-24.0-15.9-25.4	.945 / 24.0	.625 / 15.9	1.000 / 25.4	100	\$ 76.65
SR-TP-24.0-19.2-19.1	.945 / 24.0	.750 / 19.2	.750 / 19.1	100	\$ 77.75
SR-TP-26.0-20.0-25.4	1.024 / 26.0	.787 / 20.0	1.000 / 25.4	100	\$ 101.50
SR-TP-27.0-23.0-25.4	1.063 / 27.0	.905 / 23.0	1.000 / 25.4	100	\$ 115.50
SR-TP-28.0-24.0-25.4	1.102 / 28.0	.945 / 24.0	1.000 / 25.4	100	\$ 126.10
SR-TP-30.0-27.8-25.4	1.181 / 30.0	1.094 / 27.8	1.000 / 25.4	50	\$ 108.45
SR-TP-32.0-26.0-25.4	1.260 / 32.0	1.024 / 26.0	1.000 / 25.4	100	\$ 156.93
SR-TP-34.0-27.0-25.4	1.338 / 34.0	1.063 / 27.0	1.000 / 25.4	100	\$ 172.48
SR-TP-37.0-30.0-25.4	1.456 / 37.0	1.180 / 30.0	1.000 / 25.4	50	\$ 108.85
SR-TP-38.7-22.9-63.5	1.525 / 38.7	.900 / 22.9	2.500 / 63.5	100	\$ 525.63
SR-TP-39.0-31.0-25.4	1.535 / 39.0	1.220 / 31.0	1.000 / 25.4	50	\$ 116.63
SR-TP-41.0-33.0-25.4	1.614 / 41.0	1.300 / 33.0	1.000 / 25.4	50	\$ 122.28
SR-TP-43.0-36.0-25.4	1.693 / 43.0	1.417 / 36.0	1.000 / 25.4	50	\$ 134.30
SR-TP-45.0-37.0-25.4	1.772 / 45.0	1.457 / 37.0	1.000 / 25.4	50	\$ 154.10
SR-TP-46.0-38.0-25.4	1.810 / 46.0	1.496 / 38.0	1.000 / 25.4	50	\$ 155.50
SR-TP-50.0-42.0-25.4	1.968 / 50.0	1.653 / 42.0	1.000 / 25.4	25	\$ 97.20
SR-TP-53.0-45.0-25.4	2.086 / 53.0	1.770 / 45.0	1.000 / 25.4	25	\$ 102.50
SR-TP-56.0-48.0-25.4	2.205 / 56.0	1.890 / 48.0	1.000 / 25.4	25	\$ 119.80
SR-TP-63.0-50.0-25.4	2.480 / 63.0	1.968 / 50.0	1.000 / 25.4	25	\$ 134.30
SR-TP-64.0-54.0-25.4	2.520 / 64.0	2.125 / 54.0	1.000 / 25.4	25	\$ 144.90
SR-TP-68.0-58.0-25.4	2.677 / 68.0	2.283 / 58.0	1.000 / 25.4	25	\$ 162.58
SR-TP-75.0-62.0-35.0	2.953 / 75.0	2.440 / 62.0	1.377 / 35.0	25	\$ 236.80
SR-TP-90.0-75.0-39.0	3.543 / 90.0	2.953 / 75.0	1.535 / 39.0	25	\$ 371.10
SR-TP-103.0-83.0-39.0	4.055 / 103.0	3.267 / 83.0	1.535 / 39.0	20	\$ 606.55
SR-TP-127.0-90.0-50.0	5.000 / 127.0	3.543 / 90.0	1.968 / 50.0	10	\$ 367.55

- For the same size plug in EPDM rubber, subtract 10% from pricing. Change prefix from "SR-TP" to "EP-TP"

Silicone Rubber Hollow Tapered Plugs High Temperature & Heat Resistant



- High Temperature natural color Silicone Rubber for use at 500°F / 260°C continuous and up to 600°F / 316°C intermittent short duration.
- Also available in EPDM (black) with a lower temperature range (425°F / 218°C).

High Temperature, Heat & Flame Resistant Silicone Rubber Hollow Tapered Plugs					
Small Size: 13.67mm x 7.1mm x 25mm to 127mm x 90mm x 50mm					
Part Number	Large End Diameter in / mm	Small End Diameter in / mm	Length in / mm	Pack Size	Price each
SR-HTP-27.0-20.3-25.4	1.061 / 27.0	.797 / 20.3	1.000 / 25.4	200	\$ 343.05
SR-HTP-30.0-27.8-25.4	1.181 / 30.0	1.094 / 27.8	1.000 / 25.4	50	\$ 73.91
SR-HTP-37.0-30.0-25.4	1.456 / 37.0	1.180 / 30.0	1.000 / 25.4	50	\$ 88.35
SR-HTP-39.0-31.0-25.4	1.535 / 39.0	1.220 / 31.0	1.000 / 25.4	50	\$ 96.83
SR-HTP-41.0-33.0-25.4	1.614 / 41.0	1.300 / 33.0	1.000 / 25.4	50	\$ 106.03
SR-HTP-43.0-36.0-25.4	1.693 / 43.0	1.417 / 36.0	1.000 / 25.4	50	\$ 113.80
SR-HTP-45.0-37.0-25.4	1.772 / 45.0	1.457 / 37.0	1.000 / 25.4	50	\$ 127.10
SR-HTP-46.0-38.0-25.4	1.810 / 46.0	1.496 / 38.0	1.000 / 25.4	50	\$ 126.53
SR-HTP-50.0-42.0-25.4	1.968 / 50.0	1.653 / 42.0	1.000 / 25.4	25	\$ 69.98
SR-HTP-53.0-45.0-25.4	2.086 / 53.0	1.770 / 45.0	1.000 / 25.4	25	\$ 77.75
SR-HTP-56.0-48.0-25.4	2.203 / 56.0	1.890 / 48.0	1.000 / 25.4	25	\$ 91.18
SR-HTP-63.0-50.0-25.4	2.480 / 63.0	1.968 / 50.0	1.000 / 25.4	25	\$ 113.10
SR-HTP-64.0-54.0-25.4	2.520 / 64.0	2.125 / 54.0	1.000 / 25.4	25	\$ 120.18
SR-HTP-68.0-58.0-25.4	2.677 / 68.0	2.283 / 58.0	1.000 / 25.4	25	\$ 134.30
SR-HTP-75.0-62.0-35.0	2.953 / 75.0	2.440 / 62.0	1.377 / 35.0	25	\$ 201.45
SR-HTP-90.0-75.0-39.0	3.543 / 90.0	2.953 / 75.0	1.535 / 39.0	25	\$ 272.13
SR-HTP-103.0-83.0-39.0	4.055 / 103.0	3.267 / 83.0	1.535 / 39.0	20	\$ 367.55
SR-HTP-127.0-90.0-50.0	5.000 / 127.0	3.543 / 90.0	1.968 / 50.0	10	\$ 281.33

- For the same size plug in EPDM rubber, subtract 10% from pricing. Change prefix from "SR-HTP" to "EP-HTP"

Silicone Rubber Straight Plugs High Temperature & Heat Resistant



- High Temperature natural color Silicone Rubber for use at 500°F / 260°C continuous and up to 600°F / 316°C intermittent short duration.
- Also available in EPDM (black) with a lower temperature range (425°F / 218°C).

High Temperature, Heat & Flame Resistant Silicone Rubber Straight Plugs

Small Size: .047" to .275" (1.2mm to 7.0mm)

Part Number	Large End Diameter in / mm	Small End Diameter in / mm	Large Diameter Length in / mm	Small Diameter Length in / mm	Pack Size	Price each
SR-SP-1.6-1.2	.062 / 1.6	.047 / 1.2	.375 / 9.5	.337 / 8.6		\$ Call
SR-SP-1.7-1.2	.067 / 1.7	.047 / 1.2	.625 / 15.9	.610 / 15.5		\$ Call
SR-SP-1.9-1.2	.073 / 1.9	.047 / 1.2	.612 / 15.5	.590 / 15.0		\$ Call
SR-SP-2.3-1.6	.091 / 2.3	.062 / 1.6	.625 / 15.9	.625 / 15.9		\$ Call
SR-SP-2.4-1.6	.093 / 2.4	.062 / 1.6	.700 / 17.8	.700 / 17.8		\$ Call
SR-SP-2.7-1.8	.105 / 2.7	.070 / 1.8	1.000 / 25.4	1.000 / 25.4		\$ Call
SR-SP-2.8-1.6	.109 / 2.8	.062 / 1.6	1.000 / 25.4	1.000 / 25.4		\$ Call
SR-SP-3.0-2.1	.118 / 3.0	.082 / 2.1	1.000 / 25.4	1.000 / 25.4		\$ Call
SR-SP-3.2-2.1	.125 / 3.2	.082 / 2.1	.625 / 15.9	.625 / 15.9		\$ Call
SR-SP-3.3-2.1	.130 / 3.3	.082 / 2.1	.650 / 16.5	.700 / 17.8		\$ Call
SR-SP-3.6-2.1	.140 / 3.6	.082 / 2.1	.625 / 15.9	.558 / 14.2		\$ Call
SR-SP-3.9-2.1	.154 / 3.9	.082 / 2.1	.632 / 16.1	.625 / 15.9		\$ Call
SR-SP-4.0-2.1	.156 / 4.0	.082 / 2.1	.625 / 15.9	.750 / 19.1		\$ Call
SR-SP-4.0-2.4	.158 / 4.0	.093 / 2.4	1.250 / 31.8	1.250 / 31.8		\$ Call
SR-SP-4.1-2.4	.162 / 4.1	.093 / 2.4	.625 / 15.9	.581 / 14.8		\$ Call
SR-SP-4.7-2.8	.187 / 4.7	.110 / 2.8	.625 / 15.9	.600 / 15.2		\$ Call
SR-SP-5.0-2.8	.195 / 5.0	.110 / 2.8	.625 / 15.9	.625 / 15.9		\$ Call
SR-SP-5.0-2.8	.197 / 5.0	.110 / 2.8	1.000 / 25.4	1.000 / 25.4		\$ Call
SR-SP-5.5-2.8	.218 / 5.5	.110 / 2.8	1.000 / 25.4	1.000 / 25.4		\$ Call
SR-SP-5.7-3.2	.225 / 5.7	.125 / 3.2	1.000 / 25.4	1.000 / 25.4		\$ Call
SR-SP-6.5-3.3	.257 / 6.5	.130 / 3.3	1.000 / 25.4	1.000 / 25.4		\$ Call
SR-SP-7.0-3.3	.275 / 7.0	.130 / 3.3	.937 / 23.8	.920 / 23.4		\$ Call

- For the same size plug in EPDM rubber, subtract 10% from pricing. Change prefix from "SR-HTP" to "EP-HTP"

Silicone Rubber Straight Plugs High Temperature & Heat Resistant



- High Temperature natural color Silicone Rubber for use at 500°F / 260°C continuous and up to 600°F / 316°C intermittent short duration.
- Also available in EPDM (black) with a lower temperature range (425°F / 218°C).

High Temperature, Heat & Flame Resistant Silicone Rubber Straight Plugs Small Size: .281" to 1.380" (7.1mm to 35.1mm)

Part Number	Large End Diameter in / mm	Small End Diameter in / mm	Large Diameter Length in / mm	Small Diameter Length in / mm	Pack Size	Price each
SR-SP-7.1-3.5	.281 / 7.1	.138 / 3.5	1.000 / 25.4	.920 / 23.4		\$ Call
SR-SP-7.9-3.7	.312 / 7.9	.147 / 3.7	1.250 / 31.8	1.250 / 31.8		\$ Call
SR-SP-8.4-6.4	.332 / 8.4	.250 / 6.4	.757 / 19.2	1.100 / 27.9		\$ Call
SR-SP-8.5-4.0	.335 / 8.5	.157 / 4.0	1.000 / 25.4	1.000 / 25.4		\$ Call
SR-SP-8.9-4.0	.350 / 8.9	.157 / 4.0	.881 / 22.4	.925 / 23.5		\$ Call
SR-SP-9.9-4.0	.388 / 9.9	.157 / 4.0	1.000 / 25.4	1.000 / 25.4		\$ Call
SR-SP-10.2-4.9	.400 / 10.2	.191 / 4.9	1.009 / 25.6	1.000 / 25.4		\$ Call
SR-SP-10.5-4.0	.414 / 10.5	.157 / 4.0	.525 / 13.3	.755 / 19.2		\$ Call
SR-SP-11.2-6.5	.440 / 11.2	.255 / 6.5	1.000 / 25.4	.990 / 25.2		\$ Call
SR-SP-11.3-4.0	.445 / 11.3	.157 / 4.0	1.000 / 25.4	1.000 / 25.4		\$ Call
SR-SP-11.9-6.4	.468 / 11.9	.250 / 6.4	1.000 / 25.4	1.000 / 25.4		\$ Call
SR-SP-12.7-6.4	.500 / 12.7	.250 / 6.4	1.000 / 25.4	1.000 / 25.4		\$ Call
SR-SP-13.0-6.4	.510 / 13.0	.250 / 6.4	1.000 / 25.4	1.000 / 25.4		\$ Call
SR-SP13.5-6.4	.530 / 13.5	.250 / 6.4	1.000 / 25.4	1.000 / 25.4		\$ Call
SR-SP15.5-6.4	.612 / 15.5	.250 / 6.4	1.000 / 25.4	1.000 / 25.4		\$ Call
SR-SP-16.3-9.5	.640 / 16.3	.375 / 9.5	1.000 / 25.4	1.000 / 25.4		\$ Call
SR-SP-17.8-9.5	.700 / 17.8	.375 / 9.5	1.250 / 31.8	1.326 / 33.7		\$ Call
SR-SP-19.6-9.5	.770 / 19.6	.375 / 9.5	1.000 / 25.4	.927 / 23.6		\$ Call
SR-SP-22.8-9.5	.896 / 22.8	.375 / 9.5	1.000 / 25.4	1.000 / 25.4		\$ Call
SR-SP-25.9-9.5	1.020 / 25.9	.375 / 9.5	1.000 / 25.4	.970 / 24.6		\$ Call
SR-SP-35.1-12.7	1.380 / 35.1	.500 / 12.7	1.000 / 25.4	1.000 / 25.4		\$ Call

- For the same size plug in EPDM rubber, subtract 10% from pricing. Change prefix from "SR-HTP" to "EP-HTP"

Silicone Rubber Adhesive, Sealant, End-Seal Dip & Paint High Temperature, Heat & Flame Resistant

Adhesive / Sealant



US-HTG-165 \$ 32.67 / cartridge

- Easy to use 10.3 oz cartridge fits caulking guns.
- Available in larger pail and bucket sizes.
- Fills gaps, seals enclosures, forms gaskets.
- 500°F / 260°C continuous rating.

US-HT-903 \$ 46.64 / cartridge (\$221.86 1 gallon pail)

- Easy to use 10.3 oz cartridge fits caulking guns.
- Available in larger pail and bucket sizes.
- Highest Temperature Rating Silicone Adhesive / Sealant at 300°C continuous rating.
- Great for Kiln and exhaust systems.

US-SRB-201 \$ 109.68 / cartridge

- Easy to use 10.3 oz cartridge fits caulking guns.
- Available in larger pail and bucket sizes.
- Cures in 60 seconds with hot air gun
- Specialty high temperature adhesive to bond silicone rubbers together – great for complex high temperature silicone rubber fabrics used in covers and protective blanket systems

End Seal Dip / Paint / Ink (Shake well or stir before use)



US-LD-1 End Seal Dip

- Easy to use 1/2 litre wide mouth jar.
- Available in larger jars & cans.
- Used to seal the ends of sleeve to prevent wicking of liquids and to prevent fraying. 500°F / 260°C continuous rating.
- Tack free in 40 minutes, cures at room temperature in 6 hours. Odor free. Non corrosive and meets Mil-A-46146 as per NAVAIR 01-1A-20.
- Add following codes to part number: -OR for oxide-red; -BLK for black; -WHT for white; -GRN for green; -BRN for brown; -YEL for yellow; -BLU for Blue
- 4oz packaged in a 2.25" ID wide mouth jar: \$ 18.76
- 1 pint (16oz) (approx 1 lb or 455g) \$46.47.
- 1 quart (32oz) (approx 2 lbs or 907g) \$ 87.20
- 1 gallon: \$229.32 / 5 gallon: \$988.40.

US-LP-1 Paint / Ink

- 500°F / 260°C continuous rating.
- Tack free in 40 minutes, cures at room temperature in 6 hours. Odor free.
- May be brushed or sprayed as a high-temperature protective coating. Can be thinned with xylene or odourless mineral spirits to alter its viscosity.
- Add following codes to part number: -OR for oxide-red; -BLK for black; -WHT for white; -GRN for green; -BRN for brown; -YEL for yellow; -BLU for Blue
- 4oz packaged in a 2.25" ID wide mouth jar: \$ 18.76
- 1 pint (16oz) (approx 1 lb or 455g) \$46.47. 1 quart (32oz) (approx 2 lbs or 907g) \$ 87.20. 1 gallon: \$229.32 / 5 gallon: \$988.40

Silicone Rubber Adhesive & Sealant for Commercial Kitchen use High Temperature, Heat & Flame Resistant

NSF Listed / Meets FDA-USDA requirements

Adhesive / Sealant



Part Number US-M90-HT-3054

\$ 23.67 / cartridge

- Easy to use 10.3 oz cartridge fits caulking guns.
- Fills gaps, seals enclosures, forms gaskets.
- 500°F / 260°C continuous rating. High Temperature Red Color.
- NSF Listed (NSF International).
- Meets FDA Extractive Requirements CFR 177.2600
- USDA Rating P-1
- U.L. Recognized
- Meets MIL-A-46106A Type I
- Fits standard caulking gun.
- Case quantity of 12 is \$241.44
- Other colors available: Clear; Aluminum; White; Black. Rated to 400°F / 232°C – Pricing is \$15.62 per cartridge – must be purchased in case quantity.

This sealant is used in Commercial Kitchen applications, including duct flange gasket sealing and access door sealing. Also used on pipe flanges to form gaskets at pharmaceutical manufacturing facilities.

Semi-Cured Silicone Rubber Bulk Compound High Temperature, Heat & Flame Resistant

Used to form gaskets, make repairs, mold small quantity run custom parts. Also used to make silicone rubber sheet, coat fabrics, sleeves and tapes. Available as a 25 pound block, boxed. Pricing is approximately \$75.00 per pound at time of publishing.

Operational temperature range of the cured silicone rubber is -70°F to +450°F.

Semi-Cured Silicone Rubber Bulk Compound						
Part Number	Color	Tensile	Elongation %	Durometer	Cure	Price
US-BULK-903	Red	800	500	45	A	\$ Call
US-BULK-930G	Green	800	500	45	A	\$ Call
US-BULK-930R	Red	800	500	45	A	\$ Call
US-BULK-966	Red	900	200	60	A	\$ Call
US-BULK-1164	Red	450	275	60	A	\$ Call
US-BULK-1017	Red	650	300	55	A	\$ Call
US-BULK-1104	Red	800	150	65	A	\$ Call
US-BULK-1125	Red	850	450	48	B	\$ Call
US-BULK-1170	Off White	900	150	80	A	\$ Call
US-BULK-1230R	Red	925	550	36	C	\$ Call
US-BULK-1230XD	Dark Gray	925	550	36	C	\$ Call
US-BULK-1242	Red	800	225	60	D	\$ Call
US-BULK-1281	Red	800	225	60	D	\$ Call
US-BULK-1302	Red	900	300	60	D	\$ Call
US-BULK-1425	Red	800	230	53	B	\$ Call
US-BULK-1479	Brown	1000	450	55	A	\$ Call
US-BULK-1482	Brown	1000	450	55	A	\$ Call
US-BULK-1494	White	840	130	74	D	\$ Call
US-BULK-1497	Light Blue	850	400	55	A	\$ Call
US-BULK-1530	Red	800	225	60	D	\$ Call
US-BULK-1782	Gray	685	124	77	D	\$ Call
US-BULK-8877	Red	900	500	50	B	\$ Call
US-BULK-11748	Red	700	550	55	E	\$ Call

Cure: A = Primary 250-350F for 15 minutes. Secondary 400F for 120 minutes
 B = Primary 350F for 15 minutes under pressure. Secondary 425F for 120 minutes
 C = Primary 300F for 15 minutes under pressure. Secondary 400F for 120 minutes
 D = Primary 250F for 15 minutes at 50 psi. Secondary 400F for 120 minutes
 E = Primary 250F for 15 minutes under pressure. No secondary

Dielectric for all versions is 400 V/mil minimum.

Due to fluctuations of the price of the component chemicals, price is by quotation.

High Temperature Silicone Rubber Extruded Profiles Gasket and Seal Shapes Heat, Flame, Molten Splash & Weld Splatter Resistant

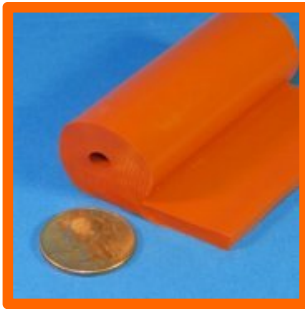

Silicone rubber extruded profiles make excellent gaskets and seals. Can be used for applications up to 500°F / 260°C continuous rating with weld splatter / molten metal splash protection. These silicone rubber products provide excellent cold temperature performance with flexibility to -76°C for refrigeration and cryogenic applications.

We offer the ability to produce many standard shapes such as:

- Tadpole
- "P" strips
- "T" Strips
- "D" Bumpers
- "L" Strips
- "U" channels
- Half rounds
- Round (cord)
- Square
- Rectangle
- Top Hat
- Baseball Hat
- Double Hat

For a full list and catalogue of available extruded profile shapes, please visit www.siliconetechnologies.com.

These profiles are also available in Fluorosilicone, Viton Fluoroelastomer, Nitrile NBR Rubber, Neoprene, Hypalon, EPDM, SBR Rubber, Polyurethane, Natural Rubber.

All pricing on extruded products is by quotation.

Silicone Rubber Electrical Flexible Strip Heaters

High Temperature, Heat & Flame Resistant



These heaters are commonly used to prevent condensation from forming in outdoor equipment such as motors and enclosures. Can be embedded under sleeving on piping to regulate process temperatures.

500°F / 260°C continuous rating with weld splatter / molten metal splash and solder drip protection. These silicone rubber products provide excellent cold temperature performance with flexibility to -76°C for refrigeration and cryogenic applications.

5 watts per inch of length. 0.055" thick. UL and CSA certified. 8" leads.

High Temperature, Heat & Flame Resistant Silicone Rubber Electrical Flexible Strip Heaters		
Part Number	Size / Watts / Voltage	Price
SR-FSH-251	1" x 5", 25 watt, 120 volt	\$ 55.70
SR-FSH-252	1" x 5", 25 watt, 240 volt	\$ 55.70
SR-FSH-501	1" x 10", 50 watt, 120 volt	\$ 58.46
SR-FSH-502	1" x 10", 50 watt, 240 volt	\$ 58.46
SR-FSH-751	1" x 15", 75 watt, 120 volt	\$ 65.90
SR-FSH-752	1" x 15", 75 watt, 240 volt	\$ 65.90
SR-FSH-1001	1" x 20", 100 watt, 120 volt	\$ 72.50
SR-FSH-1002	1" x 20", 100 watt, 240 volt	\$ 72.50
SR-FSH-1251	1" x 25", 125 watt, 120 volt	\$ 84.50
SR-FSH-1501	2" x 15", 150 watt, 120 volt	\$ 86.73
SR-FSH-1502	2" x 15", 150 watt, 240 volt	\$ 86.73
SR-FSH-2001	2" x 20", 200 watt, 120 volt	\$ 88.60
SR-FSH-2002	2" x 20", 200 watt, 240 volt	\$ 88.60
SR-FSH-2501	2" x 25", 250 watt, 120 volt	\$ 92.38
SR-FSH-2502	2" x 25", 250 watt, 240 volt	\$ 92.38

Electrical Flexible Strip Heaters Polyimide & Silicone Rubber

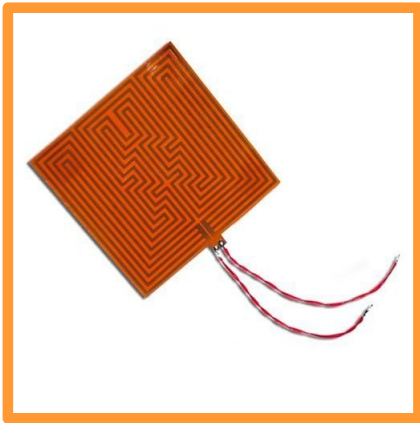

- Ultra thin profile
- High wattage density
- Uniform heat distribution
- 12" Teflon coated leads
- Pressure sensitive adhesive backing
- UL / CSA Approved and RoHS compliant
- Polyimide Film is useable to 392°F / 200°C. 0.01" / 0.25mm total thickness. This is the thinnest and highest dielectric strength.
- Silicone Rubber is useable to 450°F / 232°C. 0.06" / 1.52mm total thickness. High moisture and chemical resistance.

Etched Foil Heaters with 12" Teflon Leads						
Part Number	Material	Size	Resistance Ohms	Watts/Voltage	Density w/in ²	Price
HTR-P-1X1SQ-115	Polyimide Film	1" x 1" Square	115	5 / 24 VDC	5	\$ 48.43
HTR-P-1X1SQ-225	Polyimide Film	1" x 1" Square	225	2.6 / 24 VDC	2.6	\$ 48.43
HTR-SR-1RD-55	Silicone Rubber	1" Round	55	10.5 / 24 VDC	13.3	\$ 48.43
HTR-SR-1X2RT-65	Silicone Rubber	1" x 2" Rectangle	65	8.9 / 24 VDC	4.4	\$ 48.43
HTR-SR-1X2RT-135	Silicone Rubber	1" x 2" Rectangle	135	4.3 / 24 VDC	2.1	\$ 48.43
HTR-P-1X4RT-25	Polyimide Film	1" x 4" Rectangle	25	23 / 24 VDC	5.8	\$ 52.65
HTR-P-1X4RT-775	Polyimide Film	1" x 4" Rectangle	775	18.6 / 120 VAC	4.6	\$ 52.64
HTR-SR-1X5RT-13	Silicone Rubber	1" x 5" Rectangle	13	44.3 / 24 VDC	18.9	\$ 52.64
HTR-SR-1X5RT-1235	Silicone Rubber	1" x 5" Rectangle	1235	11.7 / 120 VAC	2.3	\$ 52.64
HTR-SR-1X10RT-25	Silicone Rubber	1" x 10" Rectangle	25	23 / 24 VDC	2.3	\$ 58.77
HTR-SR-1XRT-325	Silicone Rubber	1" x 10" Rectangle	325	44 / 120 VAC	4.4	\$ 58.77
HTR-P-2X2SQ-30	Polyimide Film	2" x 2" Square	30	19.2 / 24 VDC	4.8	\$ 54.83
HTR-P-2X2SQ-390	Polyimide Film	2" x 2" Square	390	9.2 / 120 VAC	9.2	\$ 54.83
HTR-P-2RD-74	Polyimide Film	2" Round	74	7.8 / 24 VDC	2.5	\$ 54.83
HTR-P-2X5RT-6.5	Polyimide Film	2" x 5" Rectangle	6.5	88.6 / 24 VDC	8.9	\$ 58.77
HTR-P-2X5RT-585	Polyimide Film	2" x 5" Rectangle	585	24.6 / 120 VAC	2.5	\$ 58.77
HTR-P-3X3SQ-4.5	Polyimide Film	3" x 3" Square	4.5	128 / 24 VDC	14.2	\$ 58.77
HTR-P-3X3SQ-625	Polyimide Film	3" x 3" Square	625	23 / 120 VAC	2.6	\$ 58.77
HTR-SR-3RD-465	Silicone Rubber	3" Round	465	31 / 120 VAC	4.4	\$ 58.77
HTR-SR-5X5SQ-2.5	Silicone Rubber	5" x 5" Square	2.5	230 / 24 VAC	9.2	\$ 74.91
HTR-SR-5X5SQ-220	Silicone Rubber	5" x 5" Square	220	65.5 / 120 VAC	2.6	\$ 74.91
HTR-SR-5RD-30	Silicone Rubber	5" Round	30	480 / 120 VAC	24.5	\$ 74.91

Drum & Pail Heaters – Standard Duty



- Helps speed the flow of high viscosity fluids such as oils, lubes, foods.
- Provides freeze protection.
- Does not contaminate or scorch product.
- Heating element is laminated between two layers of 15 mil fiberglass reinforced silicone rubber.
- Adjustable thermostat 50°F to 425°F (10°C to 218°C)
- Moisture and chemical resistant.
- Spring connects each end of heater band to hold itself onto drum/pail.

Standard Drum & Pail Heaters			
Part Number	Size	Voltage	Price
SR-DPH-MET5-X	5 gallon (19 litre) 300 watt	120 / 240	\$ 143.00
SR-DPH-MET5-X	5 gallon (19 litre) 550 watt	120 / 240	\$ 143.00
SR-DPH-POLY5-X	5 gallon (19 litre) 150 watt	120 / 240	\$ 143.00
SR-DPH-MET15-X	15 gallon (57 litre) 500 watt	120 / 240	\$ 155.00
SR-DPH-MET15-X	15 gallon (57 litre) 700 watt	120 / 240	\$ 155.00
SR-DPH-POLY15-X	15 gallon (57 litre) 200 watt	120 / 240	\$ 155.00
SR-DPH-MET30-X	30 gallon (114 litre) 750 watt	120 / 240	\$ 167.00
SR-DPH-MET30-X	30 gallon (114 litre) 1000 watt	120 / 240	\$ 167.00
SR-DPH-POLY30-X	30 gallon (114 litre) 250 watt	120 / 240	\$ 167.00
SR-DPH-MET55-X	55 gallon (208 litre) 1100 watt	120 / 240	\$ 176.00
SR-DPH-MET55-X	55 gallon (208 litre) 1200 watt	120 / 240	\$ 176.00
SR-DPH-POLY55-X	55 gallon (208 litre) 300 watt	120 / 240	\$ 176.00

For the X value, specify “120” for 120 volt or “240” for 220-240 volt operation

Drum & Pail Heaters – Heavy Duty / Heavy Duty with CSA Approval



- Helps speed the flow of high viscosity fluids such as oils, lubes, foods.
- Provides freeze protection.
- Does not contaminate or scorch product.
- Heating element is laminated between two layers of 20 mil fiberglass reinforced silicone rubber.
- Adjustable thermostat 50 to 160F for poly drums. 50 to 425F.
- Moisture and chemical resistant.
- Spring connects each end of heater band to hold itself onto drum/pail.

Heavy Duty Drum & Pail Heaters (Non CSA)			
Part Number	Size	Voltage	Price
SR-DPH-HD-MET5-X	5 gallon (19 litre) 550 watt	120 / 240	\$ 193.00
SR-DPH-HD-POLY5-X	5 gallon (19 litre) 150 watt	120 / 240	\$ 193.00
SR-DPH-HD-MET15-X	15 gallon (57 litre) 700 watt	120 / 240	\$ 212.00
SR-DPH-HD-POLY15-X	15 gallon (57 litre) 200 watt	120 / 240	\$ 212.00
SR-DPH-HD-MET30-X	30 gallon (114 litre) 1000 watt	120 / 240	\$ 238.00
SR-DPH-HD-POLY30-X	30 gallon (114 litre) 250 watt	120 / 240	\$ 238.00
SR-DPH-HD-MET55-X	55 gallon (208 litre) 1200 watt	120 / 240	\$ 266.00
SR-DPH-HD-POLY55-X	55 gallon (208 litre) 300 watt	120 / 240	\$ 266.00

For the X value, specify "120" for 120 volt or "240" for 220-240 volt operation

Heavy Duty Drum & Pail Heaters with CSA Approval			
Part Number	Size	Voltage	Price
SR-DPH-HD-C-MET-X	5 gallon (19 litre) 550 watt	120 / 240	\$ 197.00
SR-DPH-HD-C-POLY5-X	5 gallon (19 litre) 150 watt	120 / 240	\$ 197.00
SR-DPH-HD-C-MET15-X	15 gallon (57 litre) 700 watt	120 / 240	\$ 219.00
SR-DPH-HD-C-POLY15-X	15 gallon (57 litre) 200 watt	120 / 240	\$ 219.00
SR-DPH-HD-C-MET30-X	30 gallon (114 litre) 1000 watt	120 / 240	\$ 245.00
SR-DPH-HD-C-POLY30-X	30 gallon (114 litre) 250 watt	120 / 240	\$ 245.00
SR-DPH-HD-C-MET55-X	55 gallon (208 litre) 1200 watt	120 / 240	\$ 273.00
SR-DPH-HD-C-POLY55-X	55 gallon (208 litre) 300 watt	120 / 240	\$ 273.00

For the X value, specify "120" for 120 volt or "240" for 220-240 volt operation

Drum Heaters – Hazardous Area Approved – T3 and T4A FM Approved – Class I, Div 2 Groups A, B, C and D. Class II Div 2 Groups F and G



- Helps speed the flow of high viscosity fluids such as oils, lubes, foods.
- Provides freeze protection.
- Does not contaminate or scorch product.
- T3 high limit is set to 292°F (145°C).
- T4A high limit is set to 158°F (70°C).
- Heating element is laminated between two layers of 23 mil fiberglass reinforced silicone rubber.

Hazardous Area Approved Drum Heaters for T3 and T4A Environments			
Part Number	Size	Voltage	Price
SR-DPH-HZ-MET30-X-Y	30 gallon (114 litre) 1000 watt	120 / 240	\$ 2078.00
SR-DPH-HZ-MET55-X-Y	55 gallon (208 litre) 1200 watt	120 / 240	\$ 2127.00

For the X value, specify “120” for 120 volt or “240” for 220-240 volt operation

For the Y value, specify “3” for the T3 version or “4” for the T4A version

Stranded Tinned Copper Wire – with High Temperature High Flexibility Silicone Rubber Extruded Jacket
Tuff-Flex™ for Extreme Flexibility for Confined Area and Motion Applications
-65°C to 260°C



- For applications up to 42,000 Volts DC. Submersible.
- Excellent alternative to PVC & PTFE jacketed wire.
- Available from 4 to 30 AWG.
- UL 94-V0/CSA and FAA Flame Tested. Excellent for long term UV exposure.
- Used in Aerospace, Solar Panel, Robotic, Medical, Oil & Gas Exploration, Wind Turbine and Welding Applications.

- Used by NASA's JPL for MSL Robot Arm (Mars Rover).
- Class 1 clean room rated (zero particulates). Meets ASTM E-595 for low out-gassing.
- Halogen free.
- Multi-conductor and Flat Cable versions.
- Jacket is 65 (Shore A) durometer.

Stranded Tinned Copper Wire with High Temperature & High Flexibility Silicone Rubber Extruded Jacket					
Single Conductor					
Part Number	AWG	Volts DC	Amp rating (at 70°F)	OD inch	Price per foot
W-SR-1C-30AWG-10KV-3A-21	30	10K	3	.21"	\$ 1.91
W-SR-1C-28AWG-12KV-5A-21	28	12K	5	.21"	\$ 1.96
W-SR-1C-26AWG-12KV-6A-22	26	12K	6	.22"	\$ 2.04
W-SR-1C-24AWG-12KV-7A-22	24	12K	7	.22"	\$ 2.19
W-SR-1C-22AWG-31KV-8A-23	22	31K	8	.23"	\$ 2.46
W-SR-1C-20AWG-31KV-10A-24	20	31K	10	.24"	\$ 2.73
W-SR-1C-18AWG-42KV-15A-25	18	42K	15	.25"	\$ 3.42
W-SR-1C-16AWG-42KV-19A-26	16	42K	19	.26"	\$ 3.56
W-SR-1C-14AWG-42KV-27A-28	14	42K	27	.28"	\$ 4.24
W-SR-1C-12AWG-42KV-36A-30	12	42K	36	.30"	\$ 4.52
W-SR-1C-10AWG-42KV-47A-33	10	42K	47	.33"	\$ 5.19
W-SR-1C-8AWG-42KV-65A-39	8	42K	65	.39"	\$ 5.99
W-SR-1C-6AWG-42KV-95A-44	6	42K	95	.44"	\$ 6.49
W-SR-1C-4AWG-42KV-125A-50	4	42K	125	.50"	\$ 7.99

- High Tensile, Bare Copper and Silver Plated conductors available.
- Available as bulk wire or assembled with connectors.
- Multi-Conductor Flat Cable version available.

High temperature silicone based Ink for printing on Silicone Rubber and EPDM / EPR Rubber

Sil-Ink™ One Component: 41 cSt viscosity



Formulated with a Silicone resin and solvent carrier. High adhesion one-part ink designed for printing primarily on silicone rubber and can also be used on EPDM and EPR with very good results. Must be thoroughly mixed prior to use.

Sil-Ink™ Thinner can be used to replace solvent loss during application process.

Additional Colors of Blue, Brown, Green, Gray, Orange, Red, Violet, Silver and Yellow are available with minimum quantity of 2 gallons. Metallic Gold and Non-metallic Gold also available.

Standard printing techniques of offset, stamping, silk screening, pad, and stencil work well with this ink. Not suitable for ink-jet printing.

This ink should be tested with your application; results may vary.

Supplied in metal cans. Ships as Hazardous.

Sales are final – No return on Ink.

SL Version – This is a special formulation ink for slower drying applications. Excellent adhesion to silicone. Some heat is beneficial to the curing process.

SL is available in White (1 gallon minimum) and Black and Blue (2 gallon minimums for both).

Sil-Ink™ High Temperature Ink for printing on Silicone Rubber and EPDM / EPR Rubber			
Part Number	Size	Color	Price
INK-1COMP-16-BK	16 oz	Black	\$ 66.00
INK-1COMP-32-BK	32 oz	Black	\$ 105.00
INK-1COMP-128-BK	128 oz	Black	\$ 310.00
INK-1COMP-128-WT	128 oz	White	\$ 310.00 / Gal
INK-1COMP-256-XX	128 oz x 2	Blue, Yellow, Silver, Red	\$ 690.00 / 2 Gal
INK-1COMP-256-XX	128 oz x 2	Brown, Green, Gray, Orange, Violet	\$ 890.00 / 2 Gal
INK-1COMP-128-GOLDMT	128 oz	Gold - metallic	\$ 467.00 / Gal
INK-1COMP-SL-256-BK	128 oz x 2	Black	\$ 660.00 / 2 Gal
INK-1COMP-SL-128-WT	128 oz	White	\$ 330.00 / Gal
INK-1COMP-SL-256-BL	128 oz x 2	Blue	\$ 660.00 / 2 Gal
SIL-INK-THINNER	128 oz	Clear Thinner	\$ 136.33 / Gal

For the "X" value, substitute:

BL for Blue, BR for Brown, GR for Green, GY for Gray, OR for Orange, RD for Red, VI for Violet, SI for Silver, YL for Yellow

Sil-Ink™ High Temperature Ink for printing on Silicone Rubber and EPDM / EPR Rubber

One Component Medium Viscosity

US-LD-1 End Seal Dip

- Easy to use 1/2 litre wide mouth jar.
- Available in larger jars & cans.
- Used to seal the ends of sleeve to prevent wicking of liquids and to prevent fraying. 500°F / 260°C continuous rating.
- Tack free in 40 minutes, cures at room temperature in 6 hours. Odor free. Non corrosive and meets Mil-A-46146 as per NAVAIR 01-1A-20.
- Add following codes to part number: -OR for oxide-red; -BLK for black; -WHT for white; -GRN for green; -BRN for brown; -YEL for yellow; -BLU for Blue
- 4oz packaged in a 2.25" ID wide mouth jar: \$ 18.76
- 1 pint (16oz) (approx 1 lb or 455g) \$46.47.
- 1 quart (32oz) (approx 2 lbs or 907g) \$ 87.20
- 1 gallon: \$229.32 / 5 gallon: \$988.40.

High Temperature, Heat, Flame, Fire, Molten Metal & Weld Splatter Protection Materials

Fax Orders: 610-340-9054 Telephone Orders: 610-906-3549 orders@abthermal.com

Section 10

Fire Retardants

Fire Stops

Fire Blocks

Fire Rated Wire – Cable - Pipe Transits

10

Fire Retardant Fabric Spray – UserMixed10-1



User Mixed Fire
Retardant Fabric Spray
Page 10-1



Expanding Foam
Firestop – UL1479
Page 10-2

Fire retardant impregnation for fabric, cloth & paper
Spray – User Mixed. For chairs, couches, curtains, wall coverings and hangings



Proprietary formulation effectively retards ignition and the spread of flames on natural and synthetic fibers and fabrics.

User mixes the impregnation powder with water at the ratio of 1 Lb (455g) of product per gallon of water for natural fabrics and 1.5 lb of product per gallon for mixed and synthetic fabrics. May also be used on paper, cardboard and non-painted wood surfaces.

1 gallon of mixed formulation covers approximately 100 sq ft of material.

Used to protect chairs, couches, curtains, wall coverings & hangings, paper & wood.

The mixed solution can be sprayed easily using a pump bottle obtained from most large department retailers or garden centres. Ensure that the pump bottle is appropriately labelled.

This formulation is not suitable for application onto non-woven and woven plastics such as polyethylene tarps or groundsheets as those materials do not absorb the formulation.

Not for use on apparel, garments or workwear.



The resulting mixture is a tested “A” Class Fire Retardant spray for curtains, fabric and upholstery, and meets CAN/ULC S109.

Also meets NEN-EN-ISO 6941/6940; DIN 4102, class B1, B2; DIN 66082 / 84; BS 5438, 5867, 5852; NFP-92 503, class M1-M3

Items washed must be re-sprayed. Items dry-cleaned must be re-sprayed after 5 dry-clean cycles.

Available in 1 pound (455 gram) jars, 5 pound cans, 20 pound pails and larger quantities.

Fire Retardant Fabric Spray Impregnation Powder		
Part Number	Size	Price
FR-FS-11	1 lb jar	\$ 52.00

Fire Rated Expanding Foam Firestop FlameShield™ 2 Hour rating meeting UL1479 – tested to ASTM-E-814



FlameShield™ expanding foam firestop is tested to ASTM E-814 and meets UL1479 to provide a 2 hour firestop.

Designed to prevent the spread of fire and smoke from one compartment to another through gaps, cracks and voids through fire rated walls and floors.

Excellent adhesion to most building materials.
Unaffected by moisture and humidity after curing.
Provides a strong and semi-rigid seal.

CFC free, easy to install and finish.

The 24 oz can provides .997 cubic foot of volume when cured. The 10 oz can provides .41 cubic foot of volume when cured.

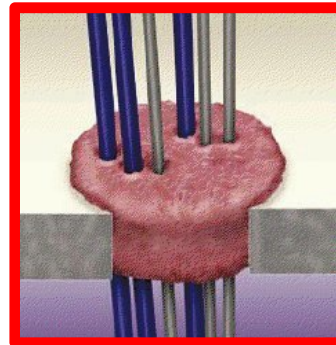

FlameShield™ Fire Rated Expanding Foam Firestop		
Part Number	Size	Price
FR-FS-FOAM-24	24oz	\$ 45.87
FR-FS-FOAM-10	10oz	\$ 26.73



Classification system:
· NFPA ratings (scale 0 - 4)



· HMIS-ratings (scale 0 - 4)



Harmful
Extremely flammable

Fire Rated Acrylic Intumescent Caulk Firestop FlameShield™ Meeting UL1479 – tested to ASTM-E-814



FlameShield™ fire rated acrylic intumescent caulk is designed to prevent the spread of fire from one compartment to another wherever services wires, cables and pipes penetrate separating walls and floors, or wherever a gap remains between elements in fire rated walls or floors.

This single part water based acrylic caulk provides a firm but flexible seal to joints in a variety of fire rated structures. It will not support combustion, and when exposed to fire it forms a carbonaceous char which expands to effectively seal any gaps, and prevents the spread of smoke and fire.

- Available in a variety of packaging sizes.
- Fast cure – tack free in 75 minutes.
- Excellent adhesion to most building materials.
- Excellent slump resistance.

FlameShield™ Fire Rated Acrylic Intumescent Caulk Firestop		
Part Number	Size	Price
FR-FS-CAULK-AIC-10C-R	10.5oz	\$ 19.63
FR-FS-CAULK-AIC-20C-R	20oz	\$ 34.17
FR-FS-CAULK-AIC-2G5-R	2.5 Gal Pail	\$ 354.00
FR-FS-CAULK-AIC-10-5G-R	5 Gal Pail	\$ 588.42
FR-FS-CAULK-AIC-10C-W	10.5oz	\$ 19.63

Fire Rated Mortar Firestop

FlameShield™ 4 Hour rated mortar Meeting UL1479 – tested to ASTM-E-814



FlameShield™ fire rated mortar firestop is easy to mix and use, and is ideal for irregular holes and defects.

This is a lightweight mortar compound that is designed to prevent the spread of fire from one compartment to another where services penetrate fire rated walls and floors.

FlameShield Mortar consists of a specially blended powder, supplied in easy to handle bags. When mixed with water, it forms a trowable or pourable mixture that is easy to install.

When exposed to the heat of a fire, the excellent thermal insulation properties provides an effective barrier, preventing the passage of fire and smoke. Unlike sand and cement mortars or concrete, the special formulation resists shrinkage, cracking, and does not spall.

During the curing process, this mortar slightly expands ensuring that an excellent seal is made even in irregular openings.

FlameShield™ 4 Hour Fire Rated Mortar Firestop		
Part Number	Size	Price
FR-FS-MORTAR	20kg / 44 lbs	\$ 166.34

Split-Sleeve Firestop for Retrofit Wire & Cable Passthrough Transit

2 and 4 Hour rated retrofit firestops for wire and cable passthrough of rated walls and floors



FlameShield™ retrofit split-sleeve fire rated firestop passthrough transit for wires and cables is the easy way to bring non-compliant installations into code passing compliance.

Simply clean up the existing hole to allow installation of the split sleeve, add the collars and support rings, insert the intrumescent putty and you have a finished retrofit that will pass inspection.

Available in several sizes and ratings for vertical fire rated walls and floors.

FlameShield™ Retrofit Split Sleeve Wire & Cable Firestop Passthrough Transits: UL 1479 classified for up to 4 hours		
Part Number	Size	Price
FR-FS-METAL-SS-1	1" Kit	\$ 81.66
FR-FS-METAL-SS-2	2" Kit	\$ 98.93
FR-FS-METAL-SS-4	4" Kit	\$ 141.34
FR-FS-FK-1	Extra Putty	\$ 37.57

Other sizes, configurations available. Floor penetration and membrane penetration kits available.

Intentionally Blank

Section 11

High Temperature Sealants and Adhesives

- Silicone Adhesives & Sealant
- Ceramic Adhesives
- Ceramic Metallic Pastes
- High Temperature Corrosion Protection Coatings



Silicone High
Temperature Sealants
and Adhesives
Page 11-1



Silica High Temperature
Stove Gasket Sealants
Page 11-2

Silicone Rubber Adhesive, Sealant High Temperature, Heat & Flame Resistant

FlameShield™ Paste Adhesive / Sealant



US-ABST-HTG-165 \$ 32.67 / cartridge

- Easy to use 10.3 oz cartridge fits caulking guns.
- Available in larger pail and bucket sizes.
- Fills gaps, seals enclosures, forms gaskets.
- 500°F / 260°C continuous rating.

US-ABST-HT-903 \$ 46.64 / cartridge

- Easy to use 10.3 oz cartridge fits caulking guns.
- Available in larger pail and bucket sizes.
- Highest Temperature Rating Silicone Adhesive / Sealant at 300°C continuous rating.
- Great for Kiln and exhaust systems.

US-ABST-SRB-201 \$ 58.87 / cartridge

- Easy to use 10.3 oz cartridge fits caulking guns.
- Available in larger pail and bucket sizes.
- Cures in 60 seconds with hot air gun
- Specialty high temperature adhesive to bond silicone rubbers together – great for complex high temperature silicone rubber fabrics used in covers and protective blanket systems

High Temperature Silica Based Gasket Cement Adhesive / Sealant

FlameShield™ Liquid Gel Adhesive / Sealant



ABST-SGC-2200 \$ 22.67 / tube

- Use for a high-temperature rigid seal.
- Adheres to all porous fibrous gasket materials.
- Can be used to effect repairs of cracks on stoves, stovepipe and masonry.
- Withstands up to 2000°F / 1093°C.
- 2 fluid oz. 59ml. Squeeze tube.
- Use by applying thin film over entire gasket channel or contact surface. Wait until tacky (10 minutes). Apply gasket material firmly into place.
- Elevate to 250°F / 121°C to fully cure

Please Note: These products are custom produced to order in small batches and all sales are final.

High Temperature Ceramic Adhesives

1560°F / 850°C to 3200°F / 1760°C

These are unique high temperature inorganic ceramic adhesive formulations for bonding and sealing ceramics, metals, quartz, graphite, carbons, textiles and composite materials and structures. High thermal and electrical resistance.

High Temperature Ceramic Adhesives					
Part Number	Filler	Feature	Bonding	Use	Price per Pint*
UCA-1509-1	Alumina	High Fired Strength	C-C	Dense Ceramics	\$ 184.21
UCA-1656-1	Alumina	Adhesion to Metal	C-C; C-M	Low CTE Metals, SOFC's	\$ 184.21
UCA-1707-1	Alumina	Set at Room Temperature. Good Filler	C-C; C-M	Probes, Sensors	\$ 184.21
UCA-1800-1	Alumina	Ceramic Fiber Reinforced	C-C	Refractory Repair	\$ 184.21
UCA-2013-1	Alumina	High Adhesion	C-C; C-M; M-M	Textiles, Threadlocking	\$ 184.21
UCA-2505-1	Alumina	High Strength. Good filler	C-C; C-M	Halogen Lamps	\$ 184.21
UCA-2505 MB-2	Alumina	High Strength. Good filler	C-C; C-M	Halogen Lamps	\$ 184.21
UCA-2439-1	Alumina	Fiber reinforced sealer	C-C; C-M	Tundish Nozzles	\$ 184.21
UCA-2595-1	Aluminum Nitride	High Thermal Conductivity	C-C; C-M	Probes, Sensors	\$ 269.87
UCA-2004-1	Alumina-Silica	Set at Room Temperature. Good Filler	C-C; C-Met	Oxygen Sensors	\$ 184.21
UCA-2031-1	Alumina-Silica	Set at Room Temperature. Good Filler	C-C; C-Met	Induction Coils	\$ 184.21
UCA-2070-1	Boron Nitride	Good Fired Strength	C-C	Boron Nitride	\$ 184.21
UCA-1653RN-1	Graphite	High Adhesive Strength	Graphite, Carbon	Structures, Molds	\$ 219.68
UCA-2007-1	Graphite	Ceramic Fiber Reinforced	Graphite, Carbon	Structures, Molds	\$ 184.21
UCA-1713-2	Magnesium Oxide	Dielectric, High Strength	C-M; M-M	Heaters, Sensors	\$ 184.21
UCA-1854-1	Silica	Low CTE, Good Strength	C-C; Quartz	Tubes, Vessels, Sensors	\$ 184.21
UCA-1548-1	Zirconia	Dielectric, Moisture Resistant	C-C; C-M; M-M	Thermocouples	\$ 184.21
UCA-2055-1	Zirconia	Bonds Plated Metals to Ceramic	C-M	Heaters, Ignitors, Gasketing	\$ 184.21
UCA-2505-1	Zirconia	Fiber reinforced, sets room temperature	C-C; C-M	Halogen Lamps	\$ 184.21
UCA-2655-1	Zirconia	Bonds and coats Zirconia, High Strength	C-C	Zirconia, SOFC's	\$ 184.21
UCA-2670-1	Silicon Carbide	Bonds SiC and Graphite Components	C-C, Graphite	High Vacuum Fixtures	\$ 184.21

Bonding: C-C is Ceramic-to-Ceramic; C-M is Ceramic-to-Metal; M-M is Metal-to-Metal. Last digit in the part number indicates number of components: 1 is a one part adhesive; 2 is a two part adhesive. Most 1 part adhesives are delivered with a six month shelf life.

* Other sizes generally available are Quart, Gallon and 5 Gallon. For Quart size, price is 1.8 x Pint price. For Gallon size, price is 3.3 x Pint price. Some items incur higher shipping charges in sizes of 1 gallon and above due to classification as hazardous (Not classified as hazardous in smaller sizes).

Easy to use one and two component systems. Most are air dry at ambient temperature for 1-2 hours, followed by a 200°F to 700°F cure.

Please Note: These products are custom produced to order in small batches and all sales are final.

HIGH TEMPERATURE CERAMIC ADHESIVE & PASTE PROPERTIES																					
Product No.	1509	1656	1707	1800	2013	2439	2505M	2004	2031	2595	2070	1653RN	2007	1713	1854	2670	1548	2055	2505	2655	
Trade Name	CerMax	CerMax	CerMax	CerMax	CerMax	CerMax	CerMax	CerMax	CerMax	CerMax	CerMax	CerMax	CerMax	CerMax	CerMax	CerMax	CerMax	CerMax	CerMax	CerMax	
Major Constituent	Alumina																				
Maximum Temperature °F (°C)	3000 (1650)	3000 (1650)	3000 (1650)	2500 (1371)	3200 (1760)	3000 (1650)	3000 (1650)	2500 (1371)	2400 (1316)	3000 (1650)	1560 (850) 2700 (1482)	5400 (2985)	3200 (1760)	3000 (1650)	2500 (1371)	2500 (1371)	3200 (1760)	2500 (1371)	3000 (1650)	3200 (1760)	
CTE, in/in°F x 10 ⁻⁶ (°C)	4.0 (7.2)	4.3 (7.7)	4.2 (7.6)	4.2 (7.6)	4.1 (7.4)	4.0 (7.2)	4.0 (7.2)	4.0 (7.2)	4.1 (7.4)	1.5 (2.7)	2.0 (3.6)	4.1 (7.4)	7.0 (12.6)	.33 (.59)	2.4 (4.4)	4.1 (7.4)	4.5 (8.1)	4.0 (7.2)	4.0 (7.2)	4.0 (7.2)	
Volume Resistivity, ohm-cm @ RT @ 1000 °F	10 ¹⁶ (10 ⁶)	10 ¹⁶ (10 ⁶)	10 ¹⁶ (10 ⁶)	10 ¹⁶ (10 ⁶)	10 ¹⁶ (10 ⁶)	10 ¹⁶ (10 ⁶)	10 ¹⁶ (10 ⁶)	10 ¹⁶ (10 ⁶)	10 ¹⁶ (10 ⁶)	10 ¹⁶ (10 ⁶)	10 ¹⁶ (10 ⁶)	NA (NA)	10 ¹⁶ (10 ⁶)	10 ¹⁶ (10 ⁶)	10 ¹⁶ (10 ⁶)	NA	10 ¹⁶ (10 ⁶)	10 ¹⁶ (10 ⁶)	10 ¹⁶ (10 ⁶)	10 ¹⁶ (10 ⁶)	
Dielectric Strength, volts per mil @ RT @ 1000 °F	253 (240)	250 (80)	256 (100)	200 (80)	250 (97)	250 (80)	245 (95)	245 (95)	200 (100)	500 (300)	500 (300)	NA (NA)	255 (100)	200 (180)	250 (80)	250 (80)	200 (150)	200 (100)	200 (100)	250 (80)	
Torque Strength, ft-lbs ²	5.6	6.7	6.0	8.3	24.0	18.5	8.5	10.6	6.3	8.3	NA	9.5	21.6	5.2	10.5	8.6	9.0	7.5	8.0	8.0	
Moisture Resistance ⁵	Good	Excellent	Excellent	Good	Excellent	Excellent	Good	Excellent	Excellent	Excellent	Good	Excellent	Excellent	Excellent	Good	Good	Good	Good	Good	Good	
Alkali Resistance ⁵	Fair	Good	Good	Good	Excellent	Excellent	Good	Excellent	Good	Good	Good	Good	Good	Good	Good	Good	Good	Good	Good	Good	
Acid Resistance ⁵	Excellent	Good	Excellent	Fair	Good	Good	Good	Good	Good	Good	Good	Good	Fair	Good	Good	Good	Good	Good	Good	Good	
Handling	No. Components ¹	1	1	1	1	1	1	1	1	1	1	1	1	2	1	1	1	1	1	1	
	Mix Ratio, powder/liquid	N/A	N/A	N/A	N/A	N/A	N/A	N/A	N/A	N/A	N/A	N/A	N/A	1.5:1	N/A	N/A	N/A	N/A	N/A	N/A	N/A
Curing	Viscosity, cP	43,000	62,000	Paste	Paste	84,000	Paste	Paste	43,000	62,000	Paste	Paste	Paste	60,000	34,000	49,000	83,000	75,000	Paste	Paste	
	Specific Gravity, gms/cc	2.50	2.07	2.30	2.16	2.24	2.18	2.41	2.17	2.01	1.40	1.56	1.58	1.50	1.60	2.18	2.24	1.85	2.41	2.99	
Color	Air Set, hours	<1	1-4	1-4	2-4	1-4	4	1	1-4	1-4	1-4	1-4	1-4	1-4	1-4	<1	1-4	2-3	<1	<1	
	Heat Cure, °F, hrs	200, 2 500, 2 700, 2	200, 2 500, 2	200, 2	200, 3	200, 2	200, 3 or 24/RT	200, 2	200, 2	200, 2	200, 2	255, 4 500, 2 700, 2	200, 2	200, 2	200, 2 500, 2 700, 2	200, 2 500, 2 700, 2	200, 2 500, 2 700, 2	200, 2 500, 2 700, 2	200, 3	200, 2	500, 2
Storage, °F	Color	White	White	White	White	White	White	White	Off White	Gray	White	Black	Black	Beige	Light Gray	Gray	Tan	Tan	Tan	Tan	
	Shelf Life, Months	6	6	6	6	6	3	6	6	6	6	6	6	6	6	6	6	6	6	6	6
Storage, °F	Shelf Life, Months	40-90	40-90	40-90	40-90	40-90	40-90	40-90	40-90	40-90	40-90	40-90	40-90	40-90	40-90	40-90	40-90	40-90	40-90	40-90	40-90
	Storage, °F	40-90	40-90	40-90	40-90	40-90	40-90	40-90	40-90	40-90	40-90	40-90	40-90	40-90	40-90	40-90	40-90	40-90	40-90	40-90	40-90

CERAMIC ADHESIVE SELECTOR CHART																						
MATERIAL	CTE X 10 ⁻⁶ in/in/ °F (°C)	1509	1548	1653RN	1656	1707	1713	1800	1854	2004	2007	2013	2031	2055	2070	2439	2505	2505M	2595	2655	2670	
		CERAMICS	ALUMINA (96%)	4.4 (7.9)	•	X		X	X	•		•		•		X		•		•		
ALUMINUM NITRIDE	1.5 (2.7)						•		X	X					X	•	X	X	•			
BERYLLIA (95%)	4.1 (7.4)		•	X		X	X	X				•				X		X				
BORON CARBIDE	2.6 (4.6)						•		X	•												
BORON NITRIDE	4.2 (3.8)		•			X						•			•	X		X				
CERAMIC TEXTILES	—		•									•			X							
CORDIERITE	1.1 (1.9)									•					X	X	X					
GLASS (Borosilicate)	1.8 (3.2)		•							•					X	•		•				
GLASS BONDED MICA	5.8 (10.4)							X							X		X	X	X			
GRAPHITE	4.3 (7.7)		X	X	•							•										X
MACOR®	5.2 (9.4)						X	X			X				X		X	X	X			
MULLITE	3.0 (5.4)		•				X								X							
QUARTZ	0.3 (.56)		X				X			•						X		•				
SAPPHIRE	4.2 (7.6)		•						•		X		•									
SILICON CARBIDE	2.9 (5.2)		•													X				X		•
SILICON NITRIDE	1.8 (3.2)									X						X				X		
STEATITE	4.0 (7.2)		•	X		X	X								X		X	X	X			
ZIRCONIA				•											•			•				•
ZIRCONIA SILICATE				•											•			•				•
REFRACTORIES	—						•		•		•		•				•	•	X			
METALS	ALUMINUM	15.0 (27.0)					•							X			X					
	BRASS	10.2 (18.4)					•						•	X			X					
	CAST IRON	5.9 (10.6)		X		X	X	•				•		X								
	COPPER	9.3 (16.7)					•						•									
	INCONEL	6.4 (11.5)		X		X	•	X														
	MOLYBDENUM	2.9 (5.2)		X		X	•		X											X		
	NICKEL	7.2 (12.9)		X		X	X	•			X				X		X		X			
	NICKEL-IRON	2.6 (4.7)		X		•	X	X			X					X		X				
	PLATINUM	4.9 (8.8)	X													X						
	SILICON	1.6 (2.9)	X	•		X	X								X							
	SILVER	10.6 (19.1)						•														
	S/S (300 SERIES)	9.6 (17.3)		X		X	X	•			X		•		X		X					
	S/S (400 SERIES)	6.2 (16.6)						•					•		X							
	STEEL (1010)	6.5 (11.7)		X		X	X	•			X		X		X		X	X	X			
	TANTALUM	3.9 (7.0)	X	X		X	•	X			•	X				X						
	TITANIUM	5.8 (10.4)					X	•			X											
TUNGSTEN	2.5 (4.5)		X		X	•			X	X					X	X				X		

• Preferred Product For This Application
X Applicable Product For This Application

UCA High Temperature Ceramic Adhesives

Design Guidelines

General design criteria for bonding with ceramic adhesives are similar to those for epoxies and other organic adhesives. Main considerations include the coefficient of thermal expansion, joint design, glue line thickness, operating environment, and an understanding of the suitability of ceramic adhesives.

Coefficient of Thermal Expansion

Due to the thermal shock implicit in most ceramic adhesives applications, the joint design should account for the difference in the coefficient of thermal expansion between the adhesive and the components that are being joined. In the illustration above, note that the "poor" design loads the ceramic adhesive in tension, since the metal expands faster than the ceramic. The "good" design allows for this thermal mismatch and loads the adhesive in compression, offering higher reliability.

Glue Line Thickness

The clearance between mating parts at operating temperature should be 2-8 mils (50–200 microns). Less than 2 mils will prevent uniform adhesion, and greater than 8 mils will often result in cohesive shear failure within the adhesive.

Operating Environment

Ceramic adhesives offer excellent electrical, thermal and chemical resistance. In addition, ceramic adhesives, in contrast to organic based materials, will not outgas under high vacuum. All operating conditions such as temperature, thermal cycling, humidity, corrosion and electrical requirements should be considered before selecting a ceramic adhesive.

Joint Design

Since ceramic adhesives exhibit relatively poor tensile and shear strength, it is desirable to design a joint that will distribute the mechanical stress. A glue line with greater surface area, such as a tongue-and-groove joint, should be used to reduce joint stress and increase mechanical strength.

Ceramic Adhesive Limitations

Ceramic adhesives are somewhat brittle and may be affected by dynamic conditions such as vibration and mechanical shock. Expansion joints can be used to relieve stress. Adding ceramic cloth at the interface is also useful.

High Vacuum Applications

Ceramic adhesives can be used under high vacuum conditions without outgassing. However, vacuum seals are difficult to produce unless the adhesive joint is sealed with a glass or glasslike coating. Refer to Technical Bulletin ABTG-A5 for glass sealants; refer to Technical Bulletin ABTG-A11 for high temperature inorganic binders.

Application Procedures

Follow the guidelines below for applying high temperature adhesives. Make sure to read specific application instructions on container before use.

Surface Preparation

Clean surfaces thoroughly prior to application. Extremely smooth surfaces are difficult to bond and should be roughened whenever possible. Porous substrates tend to absorb the adhesive binders and should be pre-coated with an adhesive thinner. Product thinners are designated by adding a "-T" to the part number (eg. 1509-T).

Mixing

High temperature adhesives tend to settle in the container and should be mixed thoroughly and slowly to avoid air entrapment. Reduce viscosity as desired using the appropriate product thinner by up to 15% by weight. Two-component systems should be mixed according to the label instructions.

Application

Apply adhesive to each surface in a thin coat using a brush, spatula or dispenser. Wet the surface thoroughly to ensure good adhesion. Maintain a uniform glue line thickness of 2-8 mils. Apply even pressure (clamp if possible), and wipe away excess material before drying. A graded adhesive joint is recommended when bonding components which have a gross difference in coefficient of thermal expansion (CTE). First coat each substrate with the adhesive that best matches its CTE, then use a third adhesive with an intermediate CTE to bond the parts together.

Example: Bond nickel to silica by pre-coating the nickel with 1713 and the silica with 1854.

Allow each substrate to air dry and cure at 200 °F for 1-2 hours. Apply 1656 as an intermediate adhesive and follow standard instructions in the Curing section. When it is necessary to use an adhesive alternatively as a coating, and several applications are required, allow the substrate to air dry for 1-2 hours before applying a second coat. A 200 °F cure for 1-2 hours is recommended for each successive coat to avoid blistering.

Curing

In general all products should be air set for 1-4 hours, then heat cured at 200 °F (93 °C) for 1-4 hours minimum.

1509, 1548, 1854, 2070, 2655, and 2670 will not dry at room temperature and should be step cured at 200 °F (93 °C), 500 °F (260 °C), and 700 °F (372 °C) for 1-2 hours at each temperature. 1653-RN must be cured at 265° F (130 °C) for 4 hours and 500 °F (260°C) for 2 hours to develop maximum strength. Blistering may occur if the glue line is too thick or heating too rapid. Refer to specific product labels for detailed instructions.

Safety

Read Material Safety Data Sheet carefully before use. All products except 1653 can be washed from the skin with mild soap and warm water. Prolonged skin contact should be avoided to prevent irritation. If any material contacts the eyes, flush continuously with water or neutralizing solutions, then consult a physician immediately.

High Temperature Ceramic-Metallic Adhesive Paste 950°F / 510°C to 2300°F / 1260°C

These ceramic-metallic adhesive pastes are used to seal joints and repair metal defects in cast aluminum, cast iron, steel and stainless steel.

Resists temperatures to 2300F; used resurface and repair metal defects, reduces scrap, is machinable, strength increases with temperature, easily painted or powder coated, easy and safe to use.

High Temperature Ceramic-Metallic Pastes						
Part Number	UCMP-1959	UCMP-2850	UCMP-3000	UCMP-4500	UCMP-7200	UCMP-7500
Type	Inorganic	Organic	Inorganic	Inorganic	Inorganic	Inorganic
Filler	Stainless	Ceramic Fiber	Aluminum	Ceramic	Stainless	Iron Oxide
Max Temp F/C	2000 / 1093	950 / 510	1400 / 760	2300 / 1260	2000 / 1093	1600 / 871
Specific Gravity	1.9	1.09	1.8	1.27	1.50	2.90
Consistency	Paste	Paste	Paste	Paste	Paste	Paste
Components	1	1	2	1	1	1
Mix Ratio	N / A	N / A	2:1	N / A	N / A	N / A
Air Set, hours	2-4	N / A	2-4	1-2	2-4	2-4
Heat Cure, temp/hrs	200 / 3	400 / 1 or 225 / 6	160 / 1-2	200 / 1	200 / 2-4	200 / 3
Color	Gray	Silver Gray	Light Gray	Gray-Brown	Dark Gray	Black
Shelf Life, months	6	6	6	6	6	6
Storage, F	40-90	40-90	40-90	40-90	40-90	40-90
Packaging	Pt, Qt, Gal, 5 Gal	11oz cartridge	Pt, Qt, Gal, 5 Gal	Pt, Qt, Gal, 5 Gal 11oz cartridge	Pt, Qt, Gal, 5 Gal	Pt, Qt, Gal, 5 Gal
Price (Pt)	\$ 188.64	\$ 66.27 (MOQ = 2)	\$ 188.64	\$ 172.84 Pt \$ 53.77 11oz (MOQ = 2)	\$ 188.64	\$ 188.64

For Quart size, price is 1.8 x Pint price. For Gallon size, price is 3.3 x Pint price.

- UCMP-1959.** For vertical surfaces and applications to ½" thick. Repairs cast iron, steel and stainless steel parts to 2000F.
- UCMP-2850** Sealing High Temperature Flanges, Joints to 950F, 750 psi. Cures into a tough pliable inert material.
- UCMP-3000** For applications to ½" thick. Repairs cast aluminum parts to 1400F.
- UCMP-4500** PriAprily used to seal boiler doors and molten metal systems. Easy to apply and removable. Use up to 2300F.
- UCMP-7200** For applications to 3/8" thick. Repairs cast iron, steel and stainless parts to 2000F.
- UCMP-7500** For applications to ¼" thick. Repairs cast iron and steel parts to 1600F.

Applications: Afterburners, Boilers, Castings, Exhaust Stacks, Flanges, Furnaces, Headers, Incinerators, Manifolds, Molds and Dies, Ovens, Heat Exchangers, Pumps, Blowers, Piping, Ducting, Turbines.

Please Note: These products are custom produced to order in small batches and all sales are final.

UCMP Ceramic Metallic Paste Application Procedures

Surface Preparation

All surfaces must be free of oil, grease, dirt, corrosives or other contaminants before application. Porous metal castings should be baked at high temperature to burn off embedded oils. Smooth metal surfaces should be abrasive blasted with a coarse media to a minimum SP-10 near white blast (0.001" minimum profile) for best results.

Mixing

All products should be mixed thoroughly to a uniform consistency prior to use. Product viscosities may be reduced by adding a maximum of 5-10% by weight of the appropriate thinner. Thinner may be ordered by adding a "-T" to the product number (eg. 1959-T). The mix ratio for UCMP-3000 is 2.0 parts powder to 1.0-1.5 parts liquid by weight. This ratio will produce the consistency of a thick paste. UCMP-3000 will outgas slightly after mixing and it is recommended that the mixture be limited to the amount required for a specific application. Store mixed material at room temperature in a plastic container that is approximately twice the mixture volume. Allow to outgas for 24 hours. Remix contents thoroughly prior to use. Note that mixture will not begin to harden in a closed container for over 24 hours. Hardening will initiate when mixture is removed from container and exposed to air.

Application

UCMP products may be applied using a spatula, putty knife or caulk gun. For cross-sections greater than 1/8" - 1/4" multiple applications should be made to avoid blistering. Cross-sections for all products should not exceed 1/2" - 3/4" (3/8" maximum for UCMP-7200).

Curing

The following instructions are guidelines for curing. Alternative cure times may be appropriate depending on the size of the application.

UCMP-1959:

- 1) Air dry for 2 hours at room temperature and up to 4 hours for thick cross-sections.
- 2) Heat cure at 200 °F for 3 hours.
- 3) For multiple applications, air set for 1-2 hours between coats, then heat cure at 200 °F for 3-4 hours after the last coat.

UCMP-2850:

- 1) This product can be cured in service at the operating temperature of the equipment.
- 2) For curing before service, heat cure the joint without pressure at 400 °F for 30-60 minutes or 225 °F for 4-6 hours.

UCMP-3000:

- 1) A heat cure is not required for cross-sections less than 1/8" thick. Air dry at room temperature for a minimum of 2-4 hours prior to use.
- 2) A heat cure is recommended for cross-sections greater than 1/8" thick Air dry at room temperature for a minimum of 2-4 hours, then heat cure at 160 °F for 1-2 hours.
- 3) After curing, this product can be sanded to achieve a bright aluminum appearance.

UCMP-4500:

- 1) This product dries at room temperature and cures in service at the operating temperature of the equipment.

UCMP-7200:

- 1) Air dry at room temperature for a minimum of 5-7 hours, longer for thick cross-sections.
- 2) A heat cure is not required if the use temperature exceeds 400 °F. Otherwise, heat cure at 200 °F for 3 hours.

UCMP-7500:

- 1) Air dry at room temperature for a minimum of 1 hour, longer for thick cross-sections.
- 2) Heat cure at 200 °F for 2 hours or air dry at room temperature for 16 hours prior to use.

Storage

Unopened containers have a six month shelf life when stored at room temperature. Make sure opened containers are capped securely to prevent evaporation. Place a plastic film in between the cap and container to prevent air leakage. The container may be inverted periodically to minimize settling. Store container between 40 °F and 90 °F.

Safety

Read Material Safety Data Sheet carefully before using any of the above products. Prolonged skin contact should be avoided due to possible irritation. In the uncured state, materials can be washed from the skin with a mild soap and water. If any material contacts eyes, flush continuously with water or neutralizing solutions, then consult a physician immediately

High Temperature Corrosion Protection Coatings

300°F / 150°C to 1500°F / 816°C

These corrosion protection coatings are based on a number of base compound groups:

Urethane / Epoxy / Inorganic Ceramic with various fillers / Silicone / Silicone-Polyester / Inorganic Ceramic-Zinc

Urethane / Epoxy

High Temperature Urethane / Epoxy Corrosion Protection Coatings						
Part Number	UCCPC-6000	UCCPC-6030	UCCPC-6060	UCCPC-6150	UCCPC-6180	UCCPC-6210
Type	Urethane	Urethane	Urethane	Epoxy-Phenolic	Decolac-Epoxy	Decolac-Epoxy
Solids by Weight %	67.0	70.0	72.0	100.0	100.0	100.0
Solids by Volume %	49.0	66.0	77.0	100.0	100.0	100.0
Max Temp F/C	400 / 204	400 / 204	400 / 204	400 / 204	500 / 260	300 / 150 ²
Specific Gravity	1.05	1.08	1.08	1.6	1.9	1.1
Mixed Viscosity, cP	200-240	300-600	200-500	Paste	Paste	800-1000
Thinner	Hi flash Naptha	Hi flash Naptha	Hi flash Naptha	NR	NR	Xylene
Components	1	1	1	2	2	2
Mix Ratio, by wt	N / A	N / A	N / A	1:1	100:8	100:42
WFT, mils (microns)	4.0 (101.6)	4.0 (101.6)	4.0 (101.6)	50+ (1270.0)	50+ (1270.0)	7.0 (177.8)
DFT, mils (microns)	2.0 (50.8)	2.6 (67.1)	3.1 (78.7)	50+ (1270.0)	50+ (1270.0)	7.0 (177.8)
Dry Film Coverage, @ 1mil, ft ² /gal, m ² /litre	722 (17.7)	1058 (25.9)	1235 (30.3)	1604 (39.3)	1604 (39.3)	1604 (39.3)
Application Temp F	50-90	50-90	50-90	50-90	50-90	50-90
Dry to Touch, hrs	4-6	4-6	4-6	6-8	4	5
Dry Handling, hrs	6-8	6-8	6-8	12-14	6-8	8
Recoat hrs (min/max)	3/7	6/12	3/7	4/48	4/8	4/8
Cure, min air set hrs	0.5	1	0.5	2	8	8
Cure, F/hrs	RT/24 or 250/1	RT/24 or 250/1	RT/24 or 250/1	RT/48 or 175/4	RT/48 or 250/6	RT/24
Flash Point, F(C)	140 (60)	140 (60)	140 (60)	>200 (93)	>200 (93)	>200 (93)
VOC's, lbs/gal	2.86	3.00	2.80	0.00	0.00	0.00
Color	Gloss Black	Aluminum ¹	Gloss Gray ¹	Brown	Gray	Gray
Pot Life, hrs RT	NA	NA	NA	.7	.75 (500 gms)	.35 (200 gms)
Packaging	Pt, Qt, Gal, 5 Gal	Pt, Qt, Gal, 5 Gal	Pt, Qt, Gal, 5 Gal	Pt, Qt, Gal, 5 Gal	Pt, Qt, Gal, 5 Gal	Pt, Qt, Gal, 5 Gal
Price (Pt)	\$ 188.64	\$ 188.64	\$ 188.64	\$ 198.91	\$ 198.91	\$ 188.64

Shelf Life for all products is 12 months at room temperature

Storage temperature for all products is 40-90 F

Primer for all products is not required

WFT = Wet Film Thickness

DFT = Recommended Dry Film Thickness

Dry Film Coverage numbers are theoretical: actual coverage will vary with material losses in mixing and application.

Please Note: These products are custom produced to order in small batches and all sales are final.

NOTES:

1. Product will discolour above 300°F.
2. Withstands intermittent service temperatures of 350-400 °F if cured for 2 hours at 185°F

Further Technical Notes for Epoxy Coatings:

Product	6150	6180
Hardness, Shore D	86	90
Lap Shear, strength to aluminum, psi		
@25C	2700	2300
@100C	1800	2000
@150C	900	1200
@175C	300	900
Flexural Strength, psi	13400	11500
Compressive Strength, psi	10300	12000
Elongation, %	3	2

Surface Preparation for all products:

All surfaces should be free of oil, grease, dirt, corrosives, oxides, paints or foreign matter. No further preparation is required when coating ceramics, refractories or graphites. Smooth metal surfaces should be further prepared as follows:

Abrasive blast to an SSPC-SP5 profile or etch surface using our UCPREP-6000 product. Apply for a maximum of 15 minutes, then rinse with warm water and dry rapidly.

Chemical Resistance Chart					
Chemical	Concentration	6000	6150	6180	6210
ACIDS					
Acetic Acid	20%	B	B	B	B
Acetic Acid	80%	B	B	B	B
Hydrochloric Acid	10%	A	A	A	A
Hydrochloric Acid	20%	A	A	A	A
Nitric Acid	10%	A	A	A	A
Nitric Acid	20%	B	B	B	B
Nitric Acid	50%	D	D	D	D
Nitric Acid	Concentrated	D	D	D	D
Phosphoric Acid	<40%	B	A	A	A
Phosphoric Acid	40-100%	D	C	C	C
Sulfuric Acid	10%	A	A	A	A
Sulfuric Acid	10-75%	C	B	B	B
Sulfuric Acid	75-100%	D	D	D	D
BASES					
Potassium Hydroxide		A	A	A	A
Sodium Hydroxide	20%	A	A	A	A
Sodium Hydroxide	50%	A	A	A	A
Sodium Hydroxide	80%	A	A	A	A
Fuels & Solvents					
Acetone		B	B	B	B
Jet Fuel		A	A	A	A
Alcohol		A	A	A	A
Crude Oil		A	A	A	A
Diesel		A	A	A	A
Gasoline		A	A	A	A
Heptane		A	A	A	A
Kerosene		A	A	A	A
Methyl Ethyl Ketone		B	B	B	B
Methylene Chloride		B	B	A	A
Toluene		A	A	A	A
Xylene		A	A	A	A

Inorganic Ceramic with various fillers

High Temperature Inorganic Ceramic Corrosion Protection Coatings						
Part Number	UCCPC-9000	UCCPC-9045-AL	UCCPC-9045-BL	UCCPC-9045-GR	UCCPC-9045-SS	UCCPC-9045-WH
Type	Inorganic	Inorganic	Inorganic	Inorganic	Inorganic	Inorganic
Solids by Weight %	53.2	36.8	50.0	44.5	42.3	40.0
Solids by Volume %	28.5	19.3	46.3	16.8	41.4	20.6
Max Temp F/C	1300 (704)	1200 (649)	1500 (816)	1400 (760)	1400 (760)	1500 (816)
Specific Gravity	1.55	1.32	1.54	1.38	1.47	1.37
Mixed Viscosity, cP	600-1200	250-900	600-900	300-700	200-500	600-900
Thinner	9000T	9045AL-T	9045BL-T	9045GR-T	9045SS-T	9045WH-T
Components	1	1	1	1	1	1
Mix Ratio, by wt	N / A	N / A	N / A	N / A	N / A	N / A
WFT, mils (microns)	3.52 (89.3)	5.20 (131.9)	2.16 (54.9)	6.00 (151.6)	2.42 (61.4)	4.87 (123.6)
DFT, mils (microns)	1.0 (25.4)	1.0 (25.4)	1.0 (25.4)	1.0 (25.4)	1.0 (25.4)	1.0 (25.4)
Dry Film Coverage, @ 1mil, ft ² /gal, m ² /litre	456 (11.2)	309 (7.6)	742 (18.2)	269 (6.6)	664 (16.3)	330 (8.1)
Application Temp F	50-90	50-90	50-90	50-90	50-90	50-90
Dry to Touch, hrs	1-2	1-2	1-2	1-2	1-2	1-2
Dry Handling, hrs	2-4	2-4	2-4	2-4	2-4	2-4
Recoat hrs (min/max)	1 / 24	1 / 24	1 / 24	1 / 24	1 / 24	1 / 24
Cure, min air set hrs	1	1	1	1	1	1
Cure, F/hrs	200/2 + 500/1	200/2 + 500/1	200/2 + 500/1	RT / 24	RT / 24	RT / 24
Flash Point, F(C)	> 212 (100)	> 212 (100)	> 212 (100)	> 212 (100)	> 212 (100)	> 212 (100)
VOC's, lbs/gal	0	0	0	0	0	0
Color	Light Gray	Aluminum	Black	Gray	Stainless Steel	White
Pot Life, hrs RT	NA	NA	NA	NA	NA	NA
Packaging	Pt, Qt, Gal, 5 Gal	Pt, Qt, Gal, 5 Gal	Pt, Qt, Gal, 5 Gal	Pt, Qt, Gal, 5 Gal	Pt, Qt, Gal, 5 Gal	Pt, Qt, Gal, 5 Gal
Price (Pt)	\$ 188.64	\$ 188.64	\$ 188.64	\$ 188.64	\$ 188.64	\$ 188.64

Shelf Life for all products is 6 months at room temperature

Storage temperature for all products is 40-85 °F

Primer for all products is not required except for exterior applications in which salt fog or moisture are present.

WFT = Wet Film Thickness

DFT = Recommended Dry Film Thickness

Dry Film Coverage numbers are theoretical: actual coverage will vary with material losses in mixing and application.

Please Note: These products are custom produced to order in small batches and all sales are final.

Silicone Based

High Temperature Silicone Based Corrosion Protection Coatings						
Part Number	UCCPC-12000	UCCPC-12030	UCCPC-12060	UCCPC-12120	UCCPC-12150	UCCPC-12180
Type	Silicone	Silicone	Silicone	Silicone	Silicone	Silicone
Solids by Weight %	51.5	44.2	44.2	44.2	48.5	46.5
Solids by Volume %	38.1	41.6	38.2	46.1	39.5	38.3
Max Temp °F/°C	1100 (593)	1100 (593)	1100 (593)	1100 (593)	1100 (593)	1100 (593)
Specific Gravity	1.32	1.05	1.28	1.27	1.31	1.31
Mixed Viscosity, cP	400-800	200-600	400-800	400-900	500-750	750-950
Thinner	Distilled Water	Distilled Water	Distilled Water	Distilled Water	Distilled Water	Distilled Water
Components	1	1	1	1	1	1
Mix Ratio, by wt	N / A	N / A	N / A	N / A	N / A	N / A
WFT, mils (microns)	2.6 (66.5)	2.4 (61.0)	2.6 (66.4)	2.2 (55.1)	2.5 (64.3)	2.6 (66.3)
DFT, mils (microns)	1.0 (25.4)	1.0 (25.4)	1.0 (25.4)	1.0 (25.4)	1.0 (25.4)	1.0 (25.4)
Dry Film Coverage, @ 1mil, ft ² /gal, m ² /litre	611 (14.9)	668 (16.4)	613 (15.1)	740 (18.2)	634 (15.6)	614 (15.1)
Application Temp °F	50-120	50-120	50-120	50-120	50-120	50-120
Dry to Touch, hrs	1-2	1-2	1-2	1-2	1-2	1-2
Dry Handling, hrs	2-4	2-4	2-4	2-4	2-4	2-4
Recoat hrs (min/max)	1 / 24	1 / 24	1 / 24	1 / 24	1 / 24	1 / 24
Cure, min air set hrs	1	1	1	1	1	1
Cure, F/hrs	450/1 or 480/.75	450/1 or 480/.75	450/1 or 480/.75	450/1 or 480/.75	450/1 or 480/.75	450/1 or 480/.75
Flash Point, F(C)	> 212 (100)	> 212 (100)	> 212 (100)	> 212 (100)	> 212 (100)	> 212 (100)
VOC's, lbs/gal	1.04	0.86	0.99	0.98	0.98	0.98
Color	Flat Black	Aluminum	Gray	White	Green	Red
Pot Life, hrs RT	NA	NA	NA	NA	NA	NA
Packaging	Pt, Qt, Gal, 5 Gal	Pt, Qt, Gal, 5 Gal	Pt, Qt, Gal, 5 Gal	Pt, Qt, Gal, 5 Gal	Pt, Qt, Gal, 5 Gal	Pt, Qt, Gal, 5 Gal
Price (Pt)	\$ 188.64	\$ 188.64	\$ 188.64	\$ 188.64	\$ 188.64	\$ 188.64

Shelf Life for all products is 6 months at room temperature

Storage temperature for all products is 55-85 °F

Primer for all products is not required except for exterior applications in which salt fog or moisture are present.

WFT = Wet Film Thickness

DFT = Recommended Dry Film Thickness

Dry Film Coverage numbers are theoretical: actual coverage will vary with material losses in mixing and application.

Please Note: These products are custom produced to order in small batches and all sales are final.

Silicone Based - Continued

High Temperature Silicone Based Corrosion Protection Coatings					
Part Number	UCCPC-12210	UCCPC-12240	UCCPC-12270	UCCPC-12285	UCCPC-15000
Type	Silicone	Silicone	Silicone	Silicone	Inorganic
Solids by Weight %	44.8	47.0	44.5	44.5	76.7
Solids by Volume %	38.5	38.0	37.8	37.8	36.8
Max Temp °F/°C	1100 (593)	1100 (593)	1100 (593)	1100 (593)	900 (482)
Specific Gravity	1.25	1.33	1.32	1.32	3.27
Mixed Viscosity, cP	300-600	500-700	300-500	500-700	1250-1750
Thinner	Distilled Water	Distilled Water	Distilled Water	Distilled Water	Distilled Water
Components	1	1	1	1	2
Mix Ratio, by wt	N / A	N / A	N / A	N / A	2:1
WFT, mils (microns)	2.6 (66.3)	2.6 (66.8)	2.7 (67.2)	2.6 (64.9)	2.7 (69.1)
DFT, mils (microns)	1.0 (25.4)	1.0 (25.4)	1.0 (25.4)	1.0 (25.4)	1.0 (25.4)
Dry Film Coverage, @ 1mil, ft ² /gal, m ² /litre	617 (15.2)	610 (15.0)	606 (14.9)	628 (15.4)	589 (14.5)
Application Temp °F	50-120	50-120	50-120	50-120	50-90
Dry to Touch, hrs	1-2	1-2	1-2	1-2	1-2
Dry Handling, hrs	2-4	2-4	2-4	2-4	2-4
Recoat hrs (min/max)	1 / 24	1 / 24	1 / 24	1 / 24	4 / 24
Cure, min air set hrs	1	1	1	1	1
Cure, F/hrs	450/1 or 480/.75	450/1 or 480/.75	450/1 or 480/.75	450/1 or 480/.75	200/2
Flash Point, F(C)	> 212 (100)	> 212 (100)	> 212 (100)	> 212 (100)	N/A
VOC's, lbs/gal	1.01	0.95	0.98	0.98	0.00
Color	Blue	Yellow	Brown	Orange	Zinc
Pot Life, hrs RT	NA	NA	NA	NA	<24
Packaging	Pt, Qt, Gal, 5 Gal	Pt, Qt, Gal, 5 Gal	Pt, Qt, Gal, 5 Gal	Pt, Qt, Gal, 5 Gal	Pt, Qt, Gal, 5 Gal
Price (Pt)	\$ 188.64	\$ 188.64	\$ 188.64	\$ 188.64	\$ 188.64

Shelf Life for all products is 6 months at room temperature

Storage temperature for all products is 55-85 °F

Primer for all products is not required except for exterior applications in which salt fog or moisture are present.

WFT = Wet Film Thickness

DFT = Recommended Dry Film Thickness

Dry Film Coverage numbers are theoretical: actual coverage will vary with material losses in mixing and application.

Please Note: These products are custom produced to order in small batches and all sales are final.

Silicone-Polyester Based

High Temperature Silicone Polyester Based Corrosion Protection Coatings					
Part Number	UCCPC-12000-S	UCCPC-12030-S	UCCPC-12060-S	UCCPC-12120-S	UCCPC-12150-S
Type	Silicone-Polyester	Silicone-Polyester	Silicone-Polyester	Silicone-Polyester	Silicone-Polyester
Solids by Weight %	69.9	37.0	62.1	42.1	62.1
Solids by Volume %	57.7	36.7	58.5	49.2	57.4
Max Cont Temp °F/°C	600 (316)	600 (316)	600 (316)	600 (316)	600 (316)
Max Int Temp °F/°C	800 (427)	800 (427)	800 (427)	800 (427)	800 (427)
Specific Gravity	1.45	1.00	1.42	1.37	1.46
Mixed Viscosity, cP	400-600	300-400	200-400	300-500	250-350
Thinner	PM Acetate	PM Acetate	PM Acetate	PM Acetate	PM Acetate
Components	1	1	1	1	1
Mix Ratio, by wt	N / A	N / A	N / A	N / A	N / A
WFT, mils (microns)	1.73 (44.0)	2.73 (69.2)	1.71 (43.4)	2.03 (51.6)	1.74 (44.3)
DFT, mils (microns)	1.0 (25.4)	1.0 (25.4)	1.0 (25.4)	1.0 (25.4)	1.0 (25.4)
Dry Film Coverage, @ 1mil, ft ² /gal, m ² /litre	925 (22.7)	589 (14.5)	938 (23.0)	789 (19.4)	920 (22.6)
Application Temp °F	50-120	50-120	50-120	50-120	50-120
Dry to Touch, hrs	1-2	1-2	1-2	1-2	1-2
Dry Handling, hrs	2-4	2-4	2-4	2-4	2-4
Recoat hrs (min/max)	1 / 24	1 / 24	1 / 24	1 / 24	1 / 24
Min air set hrs	1	1	1	1	1
Cure, F/hrs	450/1 or 480/.75	450/1 or 480/.75	450/1 or 480/.75	450/1 or 480/.75	450/1 or 480/.75
Flash Point, F(C)	118 (48)	115 (46)	115 (46)	115 (46)	115 (46)
VOC's, lbs/gal	3.6	5.3	3.6	3.4	3.7
Color	Black	Aluminum	Gray	White	Green
Pot Life, hrs RT	NA	NA	NA	NA	<24
Packaging	Pt, Qt, Gal, 5 Gal	Pt, Qt, Gal, 5 Gal	Pt, Qt, Gal, 5 Gal	Pt, Qt, Gal, 5 Gal	Pt, Qt, Gal, 5 Gal
Price (Pt)	\$ 227.86	\$ 227.86	\$ 227.86	\$ 227.86	\$ 227.86

Shelf Life for all products is 6 months at room temperature

Storage temperature for all products is 40-90 °F

Primer for all products is not required except for exterior applications in which salt fog or moisture are present.

WFT = Wet Film Thickness

DFT = Recommended Dry Film Thickness

Dry Film Coverage numbers are theoretical: actual coverage will vary with material losses in mixing and application.

Please Note: These products are custom produced to order in small batches and all sales are final.

Silicone-Polyester Based - Continued

High Temperature Silicone Polyester Based Corrosion Protection Coatings					
Part Number	UCCPC-12180-S	UCCPC-12210-S	UCCPC-12240-S	UCCPC-12270-S	UCCPC-12285-S
Type	Silicone-Polyester	Silicone-Polyester	Silicone-Polyester	Silicone-Polyester	Silicone-Polyester
Solids by Weight %	62.1	62.1	62.1	62.1	62.1
Solids by Volume %	57.4	59.0	57.7	58.6	58.9
Max Cont Temp °F/°C	600 (316)	600 (316)	600 (316)	600 (316)	600 (316)
Max Int Temp °F/°C	800 (427)	800 (427)	800 (427)	800 (427)	800 (427)
Specific Gravity	1.47	1.43	1.40	1.45	1.40
Mixed Viscosity, cP	500-700	150-250	300-500	400-600	550-750
Thinner	PM Acetate	PM Acetate	PM Acetate	PM Acetate	PM Acetate
Components	1	1	1	1	1
Mix Ratio, by wt	N / A	N / A	N / A	N / A	N / A
WFT, mils (microns)	1.74 (44.3)	1.69 (43.0)	1.73 (44.0)	1.71 (43.3)	1.70 (43.2)
DFT, mils (microns)	1.0 (25.4)	1.0 (25.4)	1.0 (25.4)	1.0 (25.4)	1.0 (25.4)
Dry Film Coverage, @ 1mil, ft ² /gal, m ² /litre	921 (22.6)	946 (23.2)	925 (22.7)	940 (23.1)	944 (23.2)
Application Temp °F	50-120	50-120	50-120	50-120	50-120
Dry to Touch, hrs	1-2	1-2	1-2	1-2	1-2
Dry Handling, hrs	2-4	2-4	2-4	2-4	2-4
Recoat hrs (min/max)	1 / 24	1 / 24	1 / 24	1 / 24	1 / 24
Min air set hrs	1	1	1	1	1
Cure, F/hrs	450/1 or 480/.75	450/1 or 480/.75	450/1 or 480/.75	450/1 or 480/.75	450/1 or 480/.75
Flash Point, F(C)	115 (46)	115 (46)	115 (46)	115 (46)	115 (46)
VOC's, lbs/gal	3.7	3.6	3.7	3.6	3.6
Color	Red	Blue	Yellow	Brown	Orange
Pot Life, hrs RT	NA	NA	NA	NA	NA
Packaging	Pt, Qt, Gal, 5 Gal	Pt, Qt, Gal, 5 Gal	Pt, Qt, Gal, 5 Gal	Pt, Qt, Gal, 5 Gal	Pt, Qt, Gal, 5 Gal
Price (Pt)	\$ 227.86	\$ 227.86	\$ 227.86	\$ 227.86	\$ 227.86

Shelf Life for all products is 6 months at room temperature

Storage temperature for all products is 40-90 °F

Primer for all products is not required except for exterior applications in which salt fog or moisture are present.

WFT = Wet Film Thickness

DFT = Recommended Dry Film Thickness

Dry Film Coverage numbers are theoretical: actual coverage will vary with material losses in mixing and application.

Please Note: These products are custom produced to order in small batches and all sales are final.

High Temperature Silicone-Ceramic Adhesive & Potting Compound 900°F / 482°C

FlameShield™ UC-2715 Adhesive Potting Compound



- Silicone Bonded – Ceramic Filled.
- Useable to 900°F / 482°C.
- Excellent Moisture Resistance.
- Used to seal and pot electronic components such as power resistors and cartridge heaters.
- Ships as Hazardous.

FlameShield™ UC-2715 Silicone-Ceramic Adhesive & Potting Compound		
Part Number	Quantity	Price
UC-2715-16	16 oz (Pint)	\$ 232.75
UC-2715-32	32 oz (Quart)	\$ 342.50
UC-2715-128	128 oz (Gallon)	\$ 610.00
UC-2715-640	640 oz (5 Gallon)	\$ 2800.17

Primary Component: Fused Silica - Silicone
Max continuous temperature: 900°F / 482°C
Dielectric Strength, volts/mil: >250
Moisture resistance: Excellent
Porosity After 900F, %: <1.0%
Shrinkage, % at 900F: <1%
Color: White
No. Of Components: 2
Mix Ratio, powder:liquid: 2.4:1
Mixed Viscosity, cP: Paste
Recommended Cure: 16-24 Hours @ room temperature +30 min @ 150°-450°F

Please Note: These products are custom produced to order in small batches and all sales are final.

Section 12 Metal Foils

- Stainless Steel 304 / 309 / 321

High Temperature, Heat, Flame, Fire, Molten Metal & Weld Splatter Protection Materials

Fax Orders: 610-340-9054 Telephone Orders: 610-906-3549 orders@abthermal.com

Stainless Steel Foil

304 / 309 / 321



Stainless steel foils can be used to form shields and barriers for protection of equipment in high heat environments.

Stainless steel foil is also excellent as a tool wrap, to protect tools from environmental factors. Resistant to corrosion and staining. Used to protect machine tools during heat treatment operations.

Stainless steel foil rolls are .002" thick by 24" wide. The cores are 3" ID. Available roll length is 50 feet and 100 feet.

Certification is available.

Maximum continuous temperature ratings:

304 Annealed Stainless Steel: 1800°F

321 Annealed Stainless Steel: 2000°F

309 Annealed Stainless Steel: 2240°F

FlameShield™ Stainless Steel Foil		
Part Number	Size	Price
FOIL-SS-304-M00005-002-24-50	.002 x 24" x 50'	\$ 264.34
FOIL-SS-304-M00005-002-24-100	.002 x 24" x 100'	\$ 428.47
FOIL-SS-309-M00005-002-24-50	.002 x 24" x 50'	\$ 298.61
FOIL-SS-321-M00005-002-24-50	.002 x 24" x 50'	\$ 219.83
FOIL-SS-321-M00005-002-24-100	.002 x 24" x 100'	\$ 418.53

Cross Reference Guide

- Industrial Firesleeve
- Aero Grade Firesleeve

X

Intentionally Blank

Cross Reference Guide: Industrial Firesleeve



See Page 1 for Pricing and Specifications

Firesleeve Cross Reference Guide – Industrial Knitted & Heavy Duty Braided

Firesleeve Part Number	McMaster-Carr® Part Number	Bentley-Harris® Fyrejacket® Part Number	AB Tech Part Number Industrial Knit	AB Tech Part Number Industrial Heavy Duty Braided
PJ-04	8772K51	4002000610F0050	S-FS-M006-04	S-FSHD-M006-04
PJ-06	8772K52	4002001010F0050	S-FS-M010-06	S-FSHD-M010-06
PJ-08	8772K54	4002001310F0050	S-FS-M013-08	S-FSHD-M013-08
PJ-10	8772K56	4002001610F0050	S-FS-M016-10	S-FSHD-M016-10
PJ-12	8772K58	4002001910F0050	S-FS-M019-12	S-FSHD-M019-12
PJ-14	8772K11	4002002210F0050	S-FS-M022-14	S-FSHD-M022-14
PJ-16	8772K61	4002002510F0050	S-FS-M025-16	S-FSHD-M025-16
PJ-18	N/A	4002002910F0050	S-FS-M029-18	S-FSHD-M029-18
PJ-20	8772K63	4002003210F0050	S-FS-M032-20	S-FSHD-M032-20
PJ-22	N/A	4002003510F0050	S-FS-M035-22	S-FSHD-M035-22
PJ-24	8772K65	4002003810F0050	S-FS-M038-24	S-FSHD-M038-24
PJ-26	N/A	4002004110F0050	S-FS-M041-26	S-FSHD-M041-26
PJ-28	8772K12	4002004510F0050	S-FS-M044-28	S-FSHD-M044-28
PJ-30	N/A	4002004810F0050	S-FS-M048-30	S-FSHD-M048-30
PJ-32	8772K69	4002005110F0050	S-FS-M051-32	S-FSHD-M051-32
PJ-36	8772K13	4002005710F0050	S-FS-M057-36	S-FSHD-M057-36
PJ-40	8772K73	4002006410F0050	S-FS-M064-40	S-FSHD-M064-40
PJ-42	N/A	4002006710F0050	S-FS-M067-42	S-FSHD-M067-42
PJ-44	8772K14	4002007010F0050	S-FS-M070-44	S-FSHD-M070-44
PJ-46	N/A	4002007310F0050	S-FS-M073-46	S-FSHD-M073-46
PJ-48	8772K77	4002007610F0050	S-FS-M076-48	S-FSHD-M076-48
PJ-52	N/A	4002008310F0050	S-FS-M083-52	S-FSHD-M083-52
PJ-56	8772K15	4002008910F0050	S-FS-M089-56	S-FSHD-M089-56
PJ-60	N/A	4002009510F0050	S-FS-M095-60	S-FSHD-M095-60
PJ-64	8772K16	4002010210F0050	S-FS-M102-64	S-FSHD-M102-64
PJ-72	N/A	4002011410F0050	S-FS-M114-72	S-FSHD-M114-72
PJ-80	N/A	4002012710F0050	S-FS-M127-80	S-FSHD-M127-80

All trademarks and trade names are property of their respective owners

Cross Reference Guide: Aero Grade Firesleeve



See Page 2 for Pricing and Specifications

Firesleeve Cross Reference Guide – Aero Grade Braided					
Firesleeve Part Number	Parker Stratoflex Part Number	Aeroquip Part Number	McMaster-Carr® Part Number	Bentley-Harris® Fyrejacket® Part Number	AB Tech Part Number
PJA-04	2650-04	AE102-4	6172T11	4001000610S	S-AS1072-M006-04
PJA-06	2650-06	AE102-6	6172T12	4001001010S	S-AS1072-M010-06
PJA-08	2650-08	AE102-8	6172T13	4001001310S	S-AS1072-M013-08
PJA-10	2650-10	AE102-10	6172T14	4001001610S	S-AS1072-M016-10
PJA-12	2650-12	AE102-12	6172T15	4001001910S	S-AS1072-M019-12
PJA-14	2650-14	AE102-14	N/A	4001002210S	S-AS1072-M022-14
PJA-16	2650-16	AE102-16	6172T16	4001002510S	S-AS1072-M025-16
PJA-18	2650-18	AE102-18	N/A	4001002910S	S-AS1072-M029-18
PJA-20	2650-20	AE102-20	6172T17	4001003210S	S-AS1072-M032-20
PJA-22	2650-22	AE102-22	N/A	4001003510S	S-AS1072-M035-22
PJA-24	2650-24	AE102-24	6172T18	4001003810S	S-AS1072-M038-24
PJA-26	2650-26	AE102-26	N/A	4001004110S	S-AS1072-M041-26
PJA-28	2650-28	AE102-28	N/A	4001004410S	S-AS1072-M044-28
PJA-30	2650-30	AE102-30	N/A	4001004810S	S-AS1072-M048-30
PJA-32	2650-32	AE102-32	6172T19	4001005110S	S-AS1072-M051-32
PJA-36	2650-36	AE102-36	N/A	4001005710S	S-AS1072-M057-36
PJA-40	2650-40	AE102-40	6172T21	4001006410S	S-AS1072-M064-40
PJA-42	2650-42	AE102-42	N/A	4001006710S	S-AS1072-M067-42
PJA-44	2650-44	AE102-44	N/A	4001007010S	S-AS1072-M070-44
PJA-46	2650-46	AE102-46	N/A	4001007310S	S-AS1072-M073-46
PJA-48	2650-48	AE102-48	6172T22	4001007610S	S-AS1072-M076-48
PJA-52	2650-52	AE102-52	N/A	4001008310S	S-AS1072-M083-52
PJA-56	2650-56	AE102-56	N/A	4001008910S	S-AS1072-M089-56
PJA-60	2650-60	AE102-60	N/A	4001009510S	S-AS1072-M095-60
PJA-64	2650-64	AE102-64	N/A	4001010210S	S-AS1072-M102-64

All trademarks and trade names are property of their respective owners

Cross Reference Guide: Aero Grade Firesleeve



See Catalog Page 1-4 for
Pricing and Specifications

Firesleeve Cross Reference Guide – Aero Grade Braided					
	Parker Stratoflex Part Number	Aeroquip Part Number	McMaster-Carr® Part Number	Bentley-Harris® Fyrejacket® Part Number	AB Tech Part Number
	2650-04	AE102-4	6172T11	4001000610S	AS1072-04 SIL-FG
	2650-06	AE102-6	6172T12	4001001010S	AS1072-06 SIL-FG
	2650-08	AE102-8	6172T13	4001001310S	AS1072-08 SIL-FG
	2650-10	AE102-10	6172T14	4001001610S	AS1072-10 SIL-FG
	2650-12	AE102-12	6172T15	4001001910S	AS1072-12 SIL-FG
	2650-14	AE102-14	N/A	4001002210S	AS1072-14 SIL-FG
	2650-16	AE102-16	6172T16	4001002510S	AS1072-16 SIL-FG
	2650-18	AE102-18	N/A	4001002910S	AS1072-18 SIL-FG
	2650-20	AE102-20	6172T17	4001003210S	AS1072-20 SIL-FG
	2650-22	AE102-22	N/A	4001003510S	AS1072-22 SIL-FG
	2650-24	AE102-24	6172T18	4001003810S	AS1072-24 SIL-FG
	2650-26	AE102-26	N/A	4001004110S	AS1072-26 SIL-FG
	2650-28	AE102-28	N/A	4001004410S	AS1072-28 SIL-FG
	2650-30	AE102-30	N/A	4001004810S	AS1072-30 SIL-FG
	2650-32	AE102-32	6172T19	4001005110S	AS1072-32 SIL-FG
	2650-36	AE102-36	N/A	4001005710S	AS1072-36 SIL-FG
	2650-40	AE102-40	6172T21	4001006410S	AS1072-40 SIL-FG
	2650-42	AE102-42	N/A	4001006710S	AS1072-42 SIL-FG
	2650-44	AE102-44	N/A	4001007010S	AS1072-44 SIL-FG
	2650-46	AE102-46	N/A	4001007310S	AS1072-46 SIL-FG
	2650-48	AE102-48	6172T22	4001007610S	AS1072-48 SIL-FG
	2650-52	AE102-52	N/A	4001008310S	AS1072-52 SIL-FG
	2650-56	AE102-56	N/A	4001008910S	AS1072-56 SIL-FG
	2650-60	AE102-60	N/A	4001009510S	AS1072-60 SIL-FG
	2650-64	AE102-64	N/A	4001010210S	AS1072-64 SIL-FG

All trademarks and trade names are property of their respective owners

Terms and Conditions

Account Application Form

T&C

Intentionally Blank

Standard Terms and Conditions

- 1. Terms and Conditions Applicable:** The terms and conditions set forth herein shall apply to the order referred to in herein. Our acceptance of this order is expressly made conditional upon assent to the terms and conditions set forth herein, which comprise all of the terms and conditions between AB Technology Group (Company) and the Purchaser respecting this order, except to the extent that any term or condition shall have been changed or modified as set forth in this agreement. Any other changes or modifications in the terms and conditions contained herein must be specifically agreed to in writing by Company.
- 2. Order Minimum:** There will be a minimum order amount required for each order received: consult the "How To Order" section for the minimum order value for each product. There will be an additional \$15.00 fee for adding items to an existing order under \$100.00. Order minimum does NOT include any tooling, overtime or freight charges. This \$15.00 fee can apply to any change made to an existing order, ex. method of shipment, shipping destination, etc.
- 3. Order Confirmation:** Company shall send a copy of the Sales Order to the purchaser by e-mail or fax. The purchaser shall notify the Company of any error in the Sales Order promptly, and not later than the end of the next business day after delivery of the Sales Order to the Purchaser. If not corrected by the Purchaser, the Sales Order shall be deemed as correct, notwithstanding the details of any communications that caused the Sales Order to be created such as verbal telephone instructions, email instructions, Purchase Order from the Purchaser, etc.
- 4. Cancellation:** Any order may not be cancelled for any reason without the consent of Company. No orders can be cancelled after production has begun.
- 5. Delivery:** Any shipping dates set forth in the purchase order or any acknowledgment of the order are the best estimate of actual delivery, but may be changed by mutual agreement. Company shall not be liable for any delays in delivery or default by reason of any occurrences or contingencies, including, but not limited to fire, flood, embargo, strike, failure to secure materials from suppliers, government restrictions considered "force majeure" or any other circumstance beyond Company's control which shall prevent Company from making the deliveries in the normal and usual course of business.
- 6. Risk of Loss:** Notwithstanding title to or ownership of the products, risk of loss shall pass to the purchaser as soon as the products are invoiced. Shipments unless otherwise requested in writing are not insured and are at the risk of the customer – any claims must be directed to the carrier.
- 7. Taxes and Fees:** Any taxes or fees imposed by any federal, provincial, state, municipal or other governmental authority, including any import or export duty that may be applicable to the sale or delivery or transportation of the product or services that may be sold by reason of this order and any and all duties, tariffs and brokerage charges, shall be added to the price of the order and paid by the purchaser except where the purchaser shall have provided a proper certification of exemption therefrom.
- 8. Method of Shipment & Fees:** Unless otherwise specified in any purchase order, acknowledgement or other specific document relating to this order, all shipments made pursuant to the order shall be made F.O.B. Kingston ON, Ogdensburg NY or nearest stocking point. In no event shall the method of shipment modify the risk of loss as specified herein. All freight collect unless otherwise specified. AB Thermal Technologies will endeavour to follow all shipping instructions, however, all freight charges invoiced are due even if AB Thermal Technologies ships by method(s) not specified. Orders may be assessed a Box and Tape fee to cover the cost of packaging materials (\$3.00 to \$12.00 dependant on size).
- 9. Terms of Payment:** Unless otherwise specified in the purchase order or acknowledgement, all products shall be sold with full payment due within thirty (30) days, if paid within ten (10) days of date of invoice, buyer may deduct one percent (1%) of the cost of goods only. Discounts are not applicable to tooling, expediting, or transportation charges. Any account for which payment has not been received within sixty (60) days from date of invoice will automatically be put on credit hold. Credit hold will also halt production of any other purchase orders that are in progress. Company welcomes payments by credit cards and electronic fund transfers. Any credit card investigation fees where the product was found to be delivered are the responsibility of the customer. Overdue accounts shall accrue interest at 2% per month from the date of becoming overdue. Accounts sent to collection may be assessed a \$250.00 collections fee. Accounts sent to the company's legal counsel for collection or litigation may be assessed an additional \$250.00 legal proceedings fee. All custom fabrications and special orders may be charged at the time that fabrication begins.
- 10. Security Interest:** Until full payment of the purchase price for any product and/or any service order pursuant to the order, Company shall retain a security interest in such products and may, at its option, and without further agreement or signature by the purchaser, file evidence of such security interest.
- 11. Warranties:** Company warrants to the original purchaser that its products, under normal use, shall be free from defects in material or workmanship provided that (a) the product has not been tampered with or repaired by any person other than Company, and (b) the product has been sold or used within the time period specified for the shelf life of the product, and (c) the purchaser notified Company in writing of any such defects immediately after discovery thereof. Company shall not be liable for any damages for any product resulting from the misuse or negligence of others or if any alterations have been made in the product which have not been authorized in writing by Company. THIS WARRANTY IS GIVEN IN LIEU OF ANY OTHER REPRESENTATION OR WARRANTIES, EXPRESS OR IMPLIED, INCLUDING, BUT NOT LIMITED TO, THE IMPLIED WARRANTY OF MERCHANTABILITY OR FITNESS FOR ANY PARTICULAR PURPOSE.
- 12. Limitation of Liabilities:** The sole and exclusive remedies of the purchaser shall be, at the option of Company, the return of the products and repayment of the price or the repair and replacement of nonconforming products and in no event shall Company be liable for the incidental and consequential damages arising from any cause whatsoever.
- 13. Product Liability:** Purchaser acknowledges that Company has no control over and is not responsible for the manner in which the products will be used or otherwise dealt with by the purchaser. The purchaser therefore agrees to assume all responsibility for any and all sums which Company and/or the purchaser become obligated to pay because of bodily injury or property damage caused by or resulting directly or indirectly from the installation, maintenance, use or operation of any products or the failure of the products to comply with any safety laws or regulations. Purchaser shall indemnify and hold Company harmless from and against any and all actions, claims or demands arising out of or in any way connected with the installation, maintenance, use or operation of the products, or the design, construction or composition of any items or items made or handled by the products supplied hereunder, including any such actions, claims and demands based in whole or in part on the default or negligence.
- 14. Proprietary Rights:** Any and all models, drawings, sketches, plans and other information supplied by one party to the other shall remain the property of the party who shall have supplied it. The other party may not use any such material or information except with respect to the products and/or services, which are subject to this sale transaction. Any product or service sold hereunder shall not constitute a license to use any of the proprietary rights of Company.
- 15. Applicable Law:** The terms and conditions of any contract arising out the transaction between the parties hereto shall be construed in accordance with the laws of the Province of Ontario for Canadian Orders and the laws of New York State for USA Orders.
- 16. Acceptance:** Hereafter, whether it be verbally or by fax or mail or e-mail, any purchase order issued to Company shall fall under these terms and agreement even if contradictory to buyers purchase terms & conditions.
- 17. Version:** The Terms and Conditions as set forth in the company catalog shall supersede any other previous Terms and Conditions that may be present in Data Sheets or Web locations.

New Account Credit Application

Please complete and return (also attach standard credit reference sheet if desired)

Are you assigning AB Technology Group a Vendor Code? If yes, please provide: _____

Legal Business Name: _____
Parent Company: _____
Address: _____ If a PO Box, please also provide street address:

Phone: _____ Fax: _____

Web Site Address : _____

DUNS Number: _____

U.S Companies Only: Federal Tax ID Number: _____

Canadian Companies Only: Business Registration Number: _____

UK Companies Only: Companies House Number: _____

Provincial Tax Exempt? Yes ___ No ___ PST Number _____

GST Exempt? Yes: ___ No: ___ GST Number: _____

Name of Owner, President or GM: _____ Title _____

Form of business: Corporation Limited Liability Company or Limited Partnership
 General Partnership Unincorporated entity

Type of business / industries served: _____

Accounts Payable contact: _____ Tel: _____

Accounts Payable E-mail: _____ Fax: _____

Estimated annual purchases \$ _____ 30 day revolving credit amount desired: \$ _____

Bank reference (name/address/phone number/bank account #)

Trade Credit References (name/address/contact information/phone/fax)

- 1) _____
- 2) _____
- 3) _____
- 4) _____

Authorizing Signature

Date

By signing this form, the applicant agrees that AB Technology Group may conduct a credit check and exchange information with other parties for the purpose of establishing credit worthiness.

For Our Privacy Statement Please Visit www.firesleeveandtape.com/privacy-policy.html

Please Note: Standard Credit Terms are 1% 10, Net 30 days